



Product Data

WeatherMaster® 48/50P2,P3,P4,P5030-100 Single-Package Gas Heating/Electric Cooling Rooftop Units and Electric Cooling Rooftop Units with Optional Electric Heat with *ComfortLink* Controls and Puron® Refrigerant (R-410A)

30 to 100 Nominal Tons



WeatherMaster®

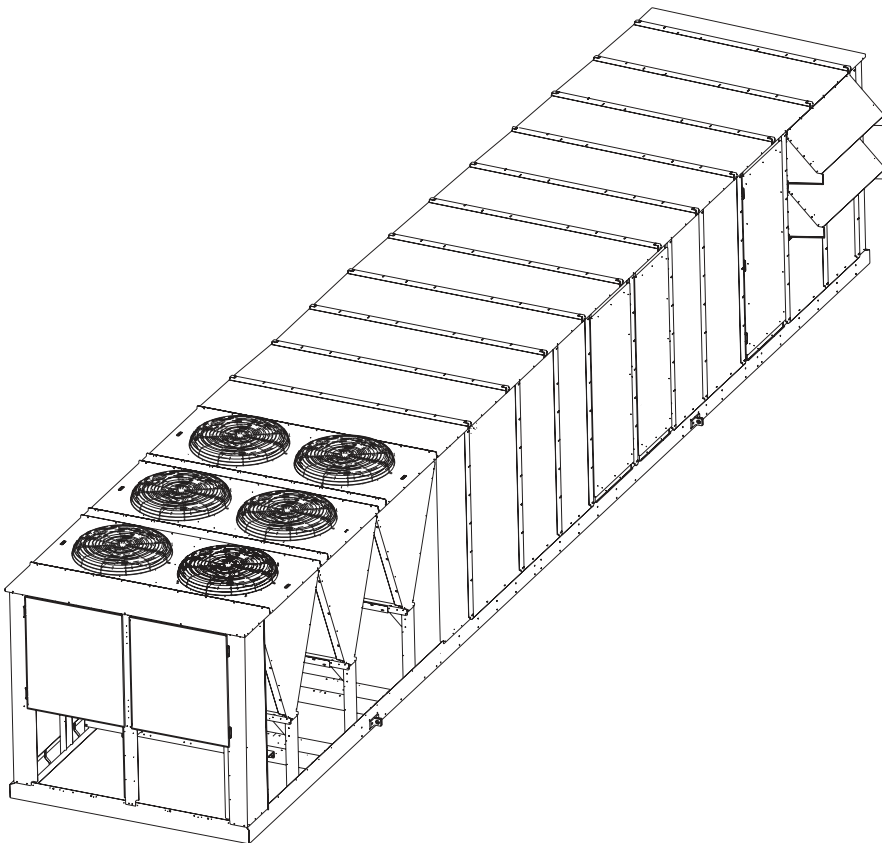

Carrier's 48/50P Series commercial packaged rooftops offer:

- Puron® refrigerant (R-410A)
- Novation® heat exchanger technology with microchannel coil
- scroll compressors
- digital scroll compressor option
- constant volume (CV)
- staged air volume (SAV™)
- variable air volume (VAV)
- vertical supply/return units
- horizontal supply/return units
- flexible chassis and plenum options
- optional return fan/modulating power exhaust
- optional high-capacity modulating power exhaust
- staged gas control option for supply air tempering
- optional modulating gas heat
- hydronic heat option
- high-capacity evaporator coil
- optional airfoil fan
- Humidi-MiZer® adaptive dehumidification option

Features/Benefits

Carrier's 48/50P commercial packaged unit offers design flexibility, quality, reliability, interoperability and *ComfortLink* controls.

***ComfortLink* controls**

Factory-installed *ComfortLink* controls provide the capability for free standing operation or may be linked with a more extensive system. Factory-installed and programmed BACnet* communication capability provides simple integration with the building HVAC system (e.g., terminal devices), an i-Vu® Open control system or a BACnet building automation system.



Features/Benefits (cont)



ComfortLink controls also have the capability to communicate with the Carrier Comfort Network® (CCN) system. This communication flexibility allows simple system integration as well as data collection, trending, monitoring and alarm displays.

The 48/50P Series may also be configured to communicate via MOD-BUS† or LonWorks** protocols, if required by the application.

The *ComfortLink* controls can also interface directly with BACnet or CCN controls on 35 and 45 Series VAV terminals to form a system for optimal efficiency and tenant comfort.

All units may also be applied to non-communicating building control systems via switch and/or 4 to 20 mA signal to provide remote occupancy control, fire shutdown and smoke control modes, IAQ (indoor air quality) modes, and demand limit sequences.

In addition, VAV units can interface with other control systems via a 4 to 20 mA signal capability which permits control of supply-air temperature reset.

Standard *ComfortLink* controls functions include:

- easy-to-use, plain English display
- supply-fan control based on occupancy schedule
- up to 6 steps of capacity control with standard scroll compressors
- digital scroll compressor option allows variable control of compressor capacity to match load requirement of the space
- lead-lag circuit control to equalize the operating hours between the dual refrigeration circuits
- 2-stage heat control
- adaptive optimal start/morning warm-up

- adaptive optimal stop (CV only)
- head pressure control to 32 F ambient outdoor-air temperature
- economizer and ventilation control
- economizer sequence enabled by standard outside air enthalpy switch
- adjustment of space set point in the occupied space on CV applications
- selectable supply air set point in both CV, SAV™, and VAV modes
- control of optional variable frequency supply-fan drives
- interface with 35 or 45 Series VAV terminals to create a system
- IAQ and demand controlled ventilation control support
- space temperature reset (VAV applications)
- local or remote unit alarm and alert monitoring
- filter maintenance alarm
- building ventilation mode purge
- self-monitoring diagnostics
- demand limiting
- external input to permit supply-air temperature reset using a 4 to 20 mA signal from another control system

A self-diagnostic microprocessor manages all unit sequences, including stages of cooling and unit safety controls. The microprocessor also controls stages of cooling and unit safety controls. At start-up, the self-diagnostic test verifies component operation and calibration. Fault codes and expanded fault descriptions reduce service troubleshooting time and difficulty.

Unique design

A unique feature of these units with *ComfortLink* controls is that the controls will support both CV, SAV, and VAV unit operations. The controls are

configured in the factory, based on the unit model and options installed.

System functions like adaptive optimal start, nighttime free cooling, building smoke control modes, occupied heating and IAQ support are resident in the controls and can be easily integrated into the control system strategy.

Environmentally balanced

Making an environmentally responsible decision is possible when using Carrier's Puron® refrigerant (R-410A). Puron refrigerant (R-410A) is an HFC refrigerant that does not contain chlorine that is damaging to the stratospheric ozone layer. Puron refrigerant (R-410A) is unaffected by the Montreal Protocol. Puron refrigerant (R-410A) is safe, efficient and environmentally balanced for the future.

Quality and reliability

Excellent full and part load efficiencies are achieved by using multiple scroll compressors and indoor coils with intertwined dual refrigerant circuits. The compressors are equipped with crankcase heaters and protected by electronic sensors and logic to control minimum on and off times and reverse rotation. The refrigerant circuits are both electrically and mechanically independent, to provide standby capability should one circuit require service.

Novation® heat exchanger technology

The Novation heat exchanger design with microchannel condenser coil is a robust, cost effective alternative to traditional coil design for standard

Table of contents

	Page
Features/Benefits	1-5
Model Number Nomenclature	6
Ratings and Capacities	7-14
Physical Data	15-36
Options and Accessories	37-43
Base Unit Dimension Examples	44-51
Accessory Dimensions	52-56
Selection Procedure	57
Performance Data	58-138
Electrical Data	139,140
Controls	141-149
Application Data	150-158
Typical Piping and Wiring	159
Typical Wiring Schematics	160-166
Guide Specifications	167-186

*Sponsored by ASHRAE (American Society of Heating, Refrigerating, and Air-Conditioning Engineers).

†Registered trademark of Schneider Electric.

**Registered trademark of Echelon corporation.

applications. Microchannel coils are also sturdier than other coil types, making them easier to clean without causing damage to the coil.

Due to the compact, all-aluminum design, microchannel coils reduce overall unit operating weight. The streamlined microchannel coil also reduces refrigerant charge by up to 40%.

Microchannel coils are not recommended by Carrier for marine, coastal, or industrial environments, unless a Carrier-approved coating is applied.

Digital scroll compressor

In air conditioning applications, the load may vary significantly, requiring a means to vary the system capacity for optimal system performance and control. The P Series large rooftop units with digital scroll compression provide a highly efficient means of capacity control using scroll compressors. The digital compressor technology provides smooth, vibration free operation by axially unloading the compliant scrolls. By varying the amount of time that the scrolls are unloaded, the P Series unit is able to precisely match the system capacity to the space load. This feature can reduce energy consumption, provide better dehumidification, reduce compressor cycling, and improve comfort in the space.

Humidi-MiZer® adaptive dehumidification system

Carrier's Humidi-MiZer adaptive dehumidification system is an all-inclusive

factory-installed option that can be ordered with any Weathermaster® 48/50P2,P3,P4,P5 rooftop unit.

This system expands the envelope of operation of the P Series rooftop to provide unprecedented flexibility that will meet year-round comfort conditions.

The Humidi-MiZer adaptive dehumidification system has the industry's only dual dehumidification mode setting. The Weathermaster rooftop, coupled with the Humidi-MiZer adaptive dehumidification system, is capable of operating in normal design cooling mode, subcooling mode, and hot gas reheat mode.

Normal design cooling mode will operate under the normal sequence of operation. Subcooling mode will operate to satisfy part load type conditions. Hot Gas Reheat mode will operate when outdoor temperatures diminish and the need for latent capacity is required for sole humidity control. Hot Gas Reheat mode will provide neutral air for maximum dehumidification operation.

The Weathermaster P Series next generation version of Carrier's Humidi-MiZer system includes refrigerant modulating valves that provide variable flow bypass around the condenser. This innovative feature ensures exact control of the supply-air temperature as the unit lowers the evaporator temperature to increase latent capacity.

Additionally, when the space requires dehumidification only, the Humidi-MiZer system can increase hot discharge gas bypass to the Humidi-MiZer coil in order to heat the air to the exact neutral state required – no overcooling or overheating with similar latent capacity as that provided in the full subcooling mode.

Staged/modulating gas control

Staged and modulating gas control options provide a supply air tempering heat function during conditions of low mixed air temperature while the system is still in Ventilation mode.

These low, mixed air conditions occur when the outdoor temperature is low and the outside-air damper is in its minimum position, so that the mixing of cold outside air and return air results in mixed-air temperatures below 50 F. Both staged and modulating gas control options will raise the air temperature leaving the unit up to the tempering mode set point. Modulating gas control option offers an enhanced control of leaving air temperature set point by continuously modulating the heat load. The modulating gas control reduces the burners on/off cycles in tempering mode.

The staged gas control option also provides additional control stages of heating operation during the normal space demand heating function. The modulating gas control option provides continuous heating modulation to satisfy the space demand for heat.

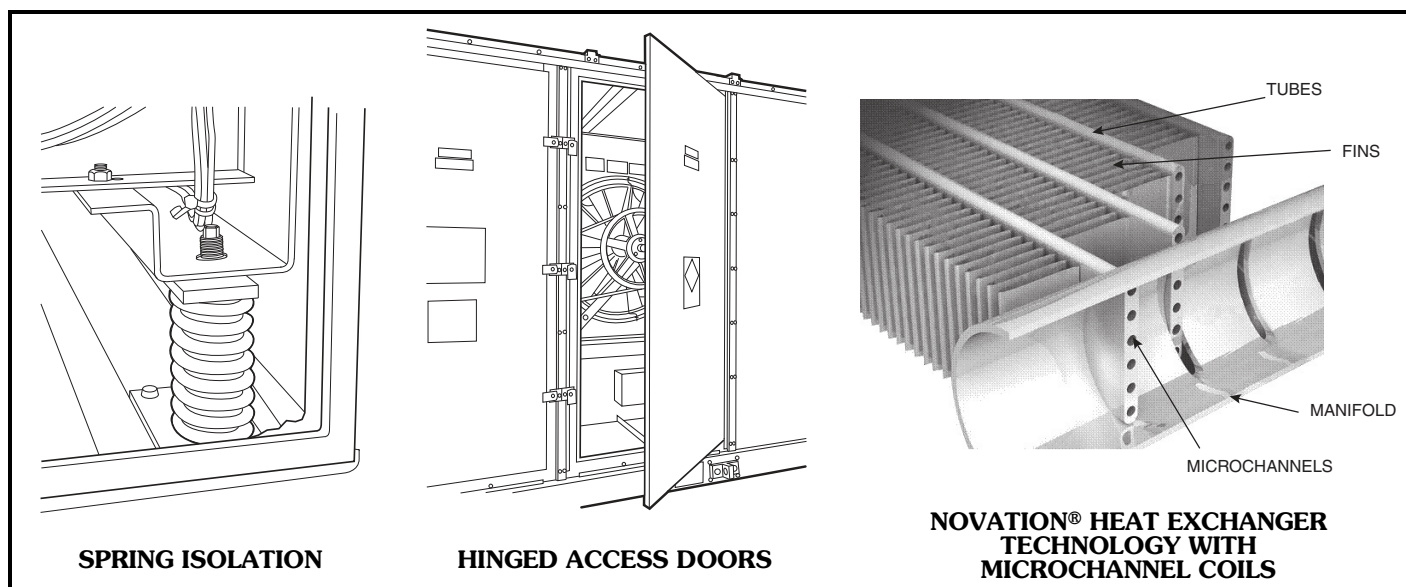

SPRING ISOLATION

HINGED ACCESS DOORS

NOVATION® HEAT EXCHANGER TECHNOLOGY WITH MICROCHANNEL COILS

Features/Benefits (cont)



Design flexibility

The P Series rooftop units with *ComfortLink* controls are designed to meet all customer requirements for new construction, replacement jobs, or special applications.

The customer can choose from the following:

- CV, SAV™ or VAV applications
- digital scroll compressors
- 4 or more supply-fan motor sizes
- 2 sizes of natural gas heat (48 Series units)
- electric heat (50 Series units)
- hydronic heat (50 Series units)
- Novation® microchannel heat exchanger (MCHX) condenser coils or e-coated MCHX condenser coils
- integrated economizer with low-leak dampers, barometric relief, or power exhaust
- ultra low leak economizer
- return fan, economizer, and high capacity power exhaust can be added to size 075-100 units.
- extended chassis units are provided with space and mounting tracks for a factory or field-installed heating coil.
- standard 2-in. filter tracks are provided but can be field-modified to accept 4-in. panel filters
- Humidi-Mizer® adaptive humidification system

Discharge options — The units can be used for vertical discharge, discharge plenum vertical discharge, or special horizontal applications, such as replacement or sound-sensitive applications. The horizontal installation allows sound to be attenuated before the duct penetrates the roof.

Exhaust and return options — For applications requiring higher space exhaust requirements on size 075-100 units, select vertical return and supply or horizontal return and supply models with optional high-capacity modulating power exhaust and integrated economizer features.

For applications requiring high return duct static pressures on sizes 075-100, select units with optional return fan and building pressure control exhaust system. The return fan provides a separate fan system dedicated to overcoming flow losses in the return duct, thus reducing the total selection load on the unit's supply fan. The return fan option includes a variable frequency drive (VFD) which modulates

return fan airflow to match supply fan airflow and to provide high exhaust flow rate (vertical return only).

Superior space pressure control is provided by specifying one of the modulating power exhaust systems. Modulating power exhaust systems control exhaust fan airflow rates to maintain a user-established space pressure set point.

The ComfortID™ solution

The 48/50P *ComfortLink* controls fully support the ComfortID system. The ComfortID system is a completely integrated control system that uses state-of-the-art Direct Digital Controls (DDC) to continually monitor and communicate the varying heating and cooling conditions in each zone of the building.

The ComfortID system capabilities go well beyond temperature control. By adding humidity, CO₂, or other IAQ sensors, indoor air quality and consistent comfort conditions can be tailor-made for each zone. Proper ventilation based on the number of occupants can be precisely maintained. Using ComfortID system for demand controlled ventilation (DCV) allows for compliance with ASHRAE (American Society of Heating, Refrigerating and Air-Conditioning Engineers) standard 62 and helps keep energy costs down. The ComfortID system does not merely monitor air quality — it maintains air quality, adjusting to promote building health.

Indoor air quality (IAQ)

All units incorporate a sloped, stainless steel condensate drain pan to prevent standing water from accumulating inside the rooftop air-conditioning unit. The condensate pan has a recessed nonferrous condensate drain connection.

Interior cabinet surfaces (except in the supply fan discharge section) are insulated with a flexible fire-retardant dual-density fiberglass blanket, coated on the air side. The coating contains an EPA (Environmental Protection Agency) registered immobilized antimicrobial agent to effectively resist the growth of bacteria and fungi.

Double wall construction in the airstream is available as an option. Double wall construction with AgION® anti-microbial coating can also be provided.

These units and controls have been developed to provide the design community with the flexibility to meet

individual job needs for both comfort and IAQ. The basic unit features include:

- integrated economizer operation to minimize mechanical cooling requirements during intermediate seasons
- optional economizers capable of handling up to 100% outdoor air
- intertwined refrigeration circuits for optimum performance at part load operation
- optional digital compressor provides improved part load control
- dual circuits with scroll compressors on each circuit for reliability and efficiency
- CV and SAV units provide multi-stage cooling capacity control based on thermostat or space sensor input
- VAV units provide multiple stage cooling capacity control for improved part load operation and efficiency
- optional digital compressors come with an infinite number of steps of staging for unmatched load matching and part load performance
- refrigeration system designed to operate down to 32 F outdoor-air temperature
- options for a minimum of 4 sizes of supply fan motors that meet or exceed motor efficiency requirements of the Energy Independence Security Act (EISA) of 2007.
- modulating power exhaust fan control
- Humidi-MiZer adaptive dehumidification system

Fan modulation

Supply fan duct pressure control on VAV models is accomplished via a variable frequency (inverter) drive (VFD). The VFD controls supply fan airflow to maintain a user-established duct pressure set point in the unit's supply duct.

Installation and serviceability

Access panels — All full-size access panels are hinged for easy access to serviceable components. No fasteners need to be removed from any units, which reduces servicing time and prevents roof leaks caused by discarded screws puncturing the roof.

Electrical connections — Single point electrical connections are standard on all units. Electrical service access can be made through roof curb or side of unit. All 48P units provide a single point gas connection.

Run testing — To ensure a successful start-up, every rooftop unit is factory run tested.

Unit design — Unit design is ETL and ETL, Canada, listed according to UL (Underwriters Laboratories) Standard 1995.

Scrolling marquee — When using the standard scrolling marquee, serviceability becomes even easier, including:

- local or remote alarm and alert monitoring
- self-diagnostic run testing to confirm control and component operation
- expedited troubleshooting and unit repair through self-diagnostic display of unit troubleshooting alert and alarm codes with expanded text descriptions to immediately identify reason for unit outage
- filter maintenance alarm
- monitoring of supply-air fan run time, permitting easy service schedule planning

Transducers — Serviceability is further facilitated with suction and discharge pressure transducers. These allow suction pressure and discharge pressure to be monitored remotely with alarm capability. These transducers also control condenser head pressure to maintain the minimum differential pressure required across the thermostatic expansion valve (TXV) for proper operation, which reduces energy consumption.

Non-fused disconnect — A factory-installed non-fused disconnect (NFD) option is available to simplify unit installation and improve unit serviceability. The location of the NFD in the main control box simplifies field power supply routing into the unit. The NFD incorporates an access panel interlock feature, ensuring that all power to the unit will be disconnected before a service person opens the control box.

Gas heat units (48P units)

The 48P units are gas heating units, using natural gas combustion, with two heat sizes available for every unit.

The unit heating systems employ multiple heat exchanger sections, with each section equipped with a 2-stage redundant gas valve and independent ignition control, with all sections operating in parallel.

Units with gas modulating heating are equipped with an additional modulating gas valve installed downstream of the 2-stage redundant gas valve.

Heat exchanger — The tubular steel heat exchanger design optimizes heat transfer for improved efficiency. The tubular design permits multiple passes across the supply air path. Each tube has an individual inshot burner, ensuring uniform combustion in each tube of the heat exchangers. Tubes are dimpled to create a turbulent gas flow to maximize heat efficiency and to ensure uniform surface temperatures for reduced corrosion effects, improved durability and long-life service. Heat exchanger material is aluminized steel or stainless steel, for improved corrosion resistance and reliability.

Integrated gas unit controller — The IGC (integrated gas unit controller) ignition and safety control system is used on each heat exchanger section. The IGC, unique to Carrier rooftop units, simplifies system evaluation and troubleshooting by providing system status and visual fault notification via an on-board LED (light-emitting diode). Ignition is initiated by a direct spark ignition system; flame status is determined by flame rectification process.

Combustion fan operation is proven by a Hall Effect speed sensor circuit for units equipped with 2-stage or staged gas heat. For units equipped with modulating gas heat, combustion fan operation is proven with a pressure switch. Safeties include flame rollout and limit switch. Auto reset with manual lockout is also provided for repeated limit switch trips. The IGC also prevents short-cycling due to thermostat jiggle by ensuring a full minute heating cycle operation on each call for heat.

Gas heat system — The induced draft fan system draws hot combustion gas through the heat exchanger tubes

at the optimum rate for the most effective heat transfer and combustion process. The heat exchanger operates under a negative pressure, preventing flue gas leakage into the indoor supply air.

Flue outlet hoods with wind baffles are located on the side of the unit, to minimize the effects of wind on heating operations.

Standard units use 2-stage control for unoccupied, morning warm-up and occupied space heating.

Additional control stages for heating operation are available by specifying the staged gas control option.

Modulating control option is available by specifying the modulating gas control option.

A single hinged panel gains access to the complete heat exchanger assembly and controls, for improved serviceability.

A single point gas connection provides for easy installation.

An LP (liquid propane) conversion accessory can be field-installed on gas units without staged or modulating gas control option (sizes 030-070 for vertical low heat units and sizes 030-050 for vertical high heat units).

Optional modulating gas heat

The modulating gas heat option monitors unit supply-air temperature and controls the unit heat exchanger to provide first-stage demand heating control, with modulation to maintain user-configured heating supply air temperature set point.

The option also provides full-fire demand heating on heating control command and tempering heat control, based on user-configured ventilation supply air temperature set point, to eliminate cold draft conditions with low mixed-air temperatures.

The modulating gas control option consists of a modulating controller capable of ensuring the proper fuel air mixture at operating firing rates, supply air temperature thermistors with duct-mounting base, a limit switch temperature thermistor, and stainless steel heat exchanger tubes.

Model number nomenclature



48P2,P3,P4,P5 UNITS

48	P2	D	030	6	1	Option Code
48 – Cooling Unit with Gas Heat						
Configuration						
P2 – Vertical Supply/Return, CV/SAV ComfortLink Controls						
P3 – Vertical Supply/Return, VAV ComfortLink Controls						
P4 – Horizontal Supply/Return, CV/SAV ComfortLink Controls						
P5 – Horizontal Supply/Return, VAV ComfortLink Controls						
Heat and Chassis Options						
– – Low Gas Heat, Humidi-MiZer® System						
A – High Gas Heat, Humidi-MiZer System						
B – Low Gas Heat, Stainless Steel						
C – High Gas Heat, Stainless Steel						
D – Low Gas Heat						
E – High Gas Heat						
F – Low Staged Gas Heat, Stainless Steel, Humidi-MiZer System						
G – High Staged Gas Heat, Stainless Steel, Humidi-MiZer System						
H – Low Staged Gas Heat, Stainless Steel						
J – High Staged Gas Heat, Stainless Steel						
K – Low Modulating Gas Heat, Stainless Steel						
L – High Modulating Gas Heat, Stainless Steel						
M – Low Gas Heat, Stainless Steel, Humidi-MiZer System						
N – High Gas Heat, Stainless Steel, Humidi-MiZer System						
P – Low Gas Heat, Stainless Steel, Extended Chassis						
Q – High Gas Heat, Stainless Steel, Extended Chassis						
R – Low Gas Heat with Extended Chassis						
S – High Gas Heat with Extended Chassis						
W – Low Staged Gas Heat, Stainless Steel, with Extended Chassis						
X – High Staged Gas Heat, Stainless Steel, with Extended Chassis						
Y – Low Modulating Gas Heat, Stainless Steel, Humidi-MiZer System						
Z – High Modulating Gas Heat, Stainless Steel, Humidi-MiZer System						
2 – Low Modulating Gas Heat, Stainless Steel, with Extended Chassis						
3 – High Modulating Gas Heat, Stainless Steel, with Extended Chassis						
Factory Options See note below						
Design Revision Level						
0 – Initial Release						
1 – First Revision						
Voltage Options						
1 – 575-3-60						
5 – 208/230-3-60						
6 – 460-3-60						
Unit Size – Nominal Tons						
030 – 30 060 – 60						
035 – 35 070 – 70						
040 – 40 075 – 75						
050 – 50 090 – 90						
055 – 55 100 – 100						
LEGEND						
CV — Constant Volume						
SAV™ — Staged Air Volume						
VAV — Variable Air Volume						
NOTE: Because of the large number of options and the many resulting combinations, the Applied Rooftop Builder software must be used to generate the 8-digit option code for the unit model number. Refer to the software for the different choices for unit factory-installed options. Once all of the options have been selected, the software will generate the correct code. Unit options and accessories are listed in the Options and Accessories section on page 37.						

50P2,P3,P4,P5 UNITS

50	P2	D	030	6	1	Option Code
50 – Cooling Unit with Electric heat						
Configuration						
P2 – Vertical Supply/Return, CV/SAV ComfortLink Controls						
P3 – Vertical Supply/Return, VAV ComfortLink Controls						
P4 – Horizontal Supply/Return, CV/SAV ComfortLink Controls						
P5 – Horizontal Supply/Return, VAV ComfortLink Controls						
Heat and Chassis Options						
- – No Heat						
A – Low Electric Heat						
B – Medium Electric Heat						
C – High Electric Heat						
D – No Heat, Humidi-MiZer System						
E – Low Electric Heat, Humidi-MiZer System						
F – Medium Electric Heat, Humidi-MiZer System						
G – High Electric Heat, Humidi-MiZer System						
H – No Heat with Discharge Plenum						
J – No Heat with Discharge Plenum, Humidi-MiZer System						
P – No Heat with Discharge Plenum and Extended Chassis						
R – No Heat with Extended Chassis						
S – Low Electric Heat with Extended Chassis						
T – Medium Electric Heat with Extended Chassis						
V – High Electric Heat with Extended Chassis						
W – No Electric Heat with Extended Chassis and Hot Water Coil						
Y – No Electric Heat with Discharge Plenum, Extended Chassis and Hot Water Coil						
Z – Low Electric Heat, Humidi-MiZer with SCR Control						
2 – Medium Electric Heat, Humidi-MiZer with SCR Control						
3 – High Electric Heat, Humidi-MiZer with SCR Control						
4 – Low Electric Heat, with Extended Chassis with SCR Control						
5 – Medium Electric Heat, with Extended Chassis with SCR Control						
6 – High Electric Heat, with Extended Chassis with SCR Control						
Factory Options See note below						
Design Revision Level						
0 – Initial Release						
1 – First Revision						
Voltage Options						
1 – 575-3-60						
2 – 380-3-60						
5 – 208/230-3-60						
6 – 460-3-60						
Unit Size – Nominal Tons						
030 – 30 060 – 60						
035 – 35 070 – 70						
040 – 40 075 – 75						
050 – 50 090 – 90						
055 – 55 100 – 100						
LEGEND						
CV — Constant Volume						
SAV — Staged Air Volume						
SCR — Silicon Controlled Rectifier Electric Heat						
VAV — Variable Air Volume						
NOTE: Because of the large number of options and the many resulting combinations, the Applied Rooftop Builder software must be used to generate the 8-digit option code for the unit model number. Refer to the software for the different choices for unit factory-installed options. Once all of the options have been selected, the software will generate the correct code. Unit options and accessories are listed in the Options and Accessories section on page 37.						

Quality Assurance

Certified to ISO 9001

Ratings and capacities



UNIT DESIGN AIRFLOW LIMITS

UNIT SIZE	UNIT TYPE	MINIMUM COOLING CFM	MAXIMUM CFM
030	48P2,P3,P4,P5 Low Heat	6,000	15,000
	48P2,P3,P4,P5 High Heat	6,000	15,000
	50P2,P3,P4,P5	6,000	15,000
035	48P2,P3,P4,P5 Low Heat	7,000	15,000
	48P2,P3,P4,P5 High Heat	7,000	15,000
	50P2,P3,P4,P5	7,000	15,000
040	48P2,P3,P4,P5 Low Heat	8,000	20,000
	48P2,P3,P4,P5 High Heat	8,000	20,000
	50P2,P3,P4,P5	8,000	20,000
050	48P2,P3,P4,P5 Low Heat	9,000	20,000
	48P2,P3,P4,P5 High Heat	9,000	19,500
	50P2,P3,P4,P5	9,000	20,000
055	48P2,P3,P4,P5 Low Heat	10,000	25,000
	48P2,P3,P4,P5 High Heat	10,000	25,000
	50P2,P3,P4,P5	10,000	25,000
060	48P2,P3,P4,P5 Low Heat	12,000	30,000
	48P2,P3,P4,P5 High Heat	12,000	30,000
	50P2,P3,P4,P5	12,000	30,000
070	48P2,P3,P4,P5 Low Heat	14,000	30,000
	48P2,P3,P4,P5 High Heat	14,000	30,000
	50P2,P3,P4,P5	14,000	30,000
075	48P2,P3,P4,P5 Low Heat	15,000	30,000
	48P2,P3,P4,P5 High Heat	15,000	30,000
	50P2,P3,P4,P5	15,000	30,000
090	48P2,P3,P4,P5 Low Heat	17,000	40,000
	48P2,P3,P4,P5 High Heat	17,000	37,000
	50P2,P3,P4,P5	17,000	40,000
100	48P2,P3,P4,P5 Low Heat	20,000	44,000
	48P2,P3,P4,P5 High Heat	20,000	37,000
	50P2,P3,P4,P5	20,000	44,000

NOTE: Refer to Application Data section for more information concerning minimum operating airflow in Cooling mode.

TWO-STAGE GAS HEATING CAPACITIES — 48P2,P3 UNITS (Natural Gas on All Units and LP Gas on 030-070 Units)

UNIT 48P2,P3	GAS INPUT (1000 Btuh)		EFFICIENCY (%)	OUTPUT CAPACITY (1000 Btuh)		TEMP RISE (F)	AIRFLOW (Cfm)	
	Stage 1	Stage 2		Stage 1	Stage 2		Min	Max
030-050 Low Heat	244	325	81.0%	197	263	10-40	6,094	20,000
030-050 High Heat	488	650	81.0%	395	527	25-55	8,864	19,259
055-070 Low Heat	488	650	80.0%	390	520	10-40	12,142	30,000
055-070 High Heat	731	975	80.0%	585	780	20-50	14,571	30,000
075-100 Low Heat	488	650	80.0%	390	520	10-40	12,172	44,000
075-100 High Heat	731	975	80.0%	585	780	20-50	14,517	36,292

LEGEND

LP — Liquid Propane

NOTES:

1. Ratings are approved for altitudes to 2000 ft. At altitudes over 2000 ft, ratings are 4% less for each 1000 ft above sea level.
2. At altitudes up to 2000 ft, the following formula may be used to calculate air temperature rise:

$$\Delta t = \frac{\text{maximum output capacity}}{1.10 \times \text{air quantity}}$$

3. At altitudes above 2000 ft, the following formula may be used:

$$\Delta t = \frac{\text{maximum output capacity}}{(.24 \times \text{specific weight of air} \times 60) (\text{air quantity})}$$

4. Minimum allowable temperature of mixed air entering the heat exchanger during half-rate (first stage) operation is 35 F. There is no minimum mixture temperature limitation during full-rate operation.
5. Temperature rise limits: see table.
6. On VAV (variable air volume) applications set the zone terminals to provide minimum unit heating airflow as indicated in the table upon command from Heat Interlock Relay (HIR) function.

Ratings and capacities (cont)



TWO-STAGE GAS HEATING CAPACITIES — 48P4,P5 UNITS (Natural Gas on All Units and LP Gas Not Available)

UNIT 48P4,P5	GAS INPUT (1000 Btuh)		EFFICIENCY (%)	OUTPUT CAPACITY (1000 Btuh)		TEMP RISE (F)	AIRFLOW (Cfm)	
	Stage 1	Stage 2		Stage 1	Stage 2		Min	Max
030-050 Low Heat	244	325	80.0%	195	260	10-40	6,019	20,000
030-050 High Heat	488	650	80.0%	390	520	25-55	8,754	19,259
055-070 Low Heat	488	650	80.0%	390	520	10-40	12,037	30,000
055-070 High Heat	731	975	80.0%	585	780	20-50	14,444	30,000
075-100 Low Heat	488	650	80.0%	390	520	10-40	12,037	44,000
075-100 High Heat	731	975	80.0%	585	780	20-50	14,444	36,111

LEGEND

LP — Liquid Propane

NOTES:

1. Ratings are approved for altitudes to 2000 ft. At altitudes over 2000 ft, ratings are 4% less for each 1000 ft above sea level.
2. At altitudes up to 2000 ft, the following formula may be used to calculate air temperature rise:

$$\Delta t = \frac{\text{maximum output capacity}}{1.10 \times \text{air quantity}}$$

3. At altitudes above 2000 ft, the following formula may be used:

$$\Delta t = \frac{\text{maximum output capacity}}{(.24 \times \text{specific weight of air} \times 60) (\text{air quantity})}$$

4. Minimum allowable temperature of mixed air entering the heat exchanger during half-rate (first stage) operation is 35 F. There is no minimum mixture temperature limitation during full-rate operation.
5. Temperature rise limits: see table.
6. On VAV (variable air volume) applications set the zone terminals to provide minimum unit heating airflow as indicated in the table upon command from Heat Interlock Relay (HIR) function.

GAS HEATING CAPACITIES — UNITS WITH STAGED GAS CONTROL OPTION

48P2,P3 030-050 LOW HEAT

HEATING STAGES	INPUT CAPACITY (1000 Btuh)	% FULL FIRE	THERMAL EFFICIENCY %	OUTPUT CAPACITY (1000 Btuh)	OUTPUT CAPACITY PER SECTION (1000 Btuh)		
					SECTION 1	SECTION 2	SECTION 3
1	244	75%	81.0%	197.4	197.4	N/A	N/A
2	325	100%	81.0%	263.3	263.3	N/A	N/A

48P4,P5 030-050 LOW HEAT

HEATING STAGES	INPUT CAPACITY (1000 Btuh)	% FULL FIRE	THERMAL EFFICIENCY %	OUTPUT CAPACITY (1000 Btuh)	OUTPUT CAPACITY PER SECTION (1000 Btuh)		
					SECTION 1	SECTION 2	SECTION 3
1	244	75%	80.0%	195.0	195.0	N/A	N/A
2	325	100%	80.0%	260.0	260.0	N/A	N/A

48P2,P3 030-050 HIGH HEAT

HEATING STAGES	INPUT CAPACITY (1000 Btuh)	% FULL FIRE	THERMAL EFFICIENCY %	OUTPUT CAPACITY (1000 Btuh)	OUTPUT CAPACITY PER SECTION (1000 Btuh)		
					SECTION 1	SECTION 2	SECTION 3
1	244	38%	81.0%	197.4	197.4	0.0	N/A
2	325	50%	81.0%	263.3	263.3	0.0	N/A
3	488	75%	81.0%	394.9	197.4	197.4	N/A
4	569	88%	81.0%	460.7	263.3	197.4	N/A
5	650	100%	81.0%	526.5	263.3	263.3	N/A

48P4,P5 030-050 HIGH HEAT

HEATING STAGES	INPUT CAPACITY (1000 Btuh)	% FULL FIRE	THERMAL EFFICIENCY %	OUTPUT CAPACITY (1000 Btuh)	OUTPUT CAPACITY PER SECTION (1000 Btuh)		
					SECTION 1	SECTION 2	SECTION 3
1	244	38%	80.0%	195.0	195.0	0.0	N/A
2	325	50%	80.0%	260.0	260.0	0.0	N/A
3	488	75%	80.0%	390.0	195.0	195.0	N/A
4	569	88%	80.0%	455.0	260.0	195.0	N/A
5	650	100%	80.0%	520.0	260.0	260.0	N/A

GAS HEATING CAPACITIES — UNITS WITH STAGED GAS CONTROL OPTION (cont)

48P2,P3 055-070 LOW HEAT

HEATING STAGES	INPUT CAPACITY (1000 Btuh)	% FULL FIRE	THERMAL EFFICIENCY %	OUTPUT CAPACITY (1000 Btuh)	OUTPUT CAPACITY PER SECTION (1000 Btuh)		
					SECTION 1	SECTION 2	SECTION 3
1	244	38%	80.0%	195.0	195.0	0.0	N/A
2	325	50%	80.0%	260.0	260.0	0.0	N/A
3	488	75%	80.0%	390.0	195.0	195.0	N/A
4	569	88%	80.0%	455.0	260.0	195.0	N/A
5	650	100%	80.0%	520.0	260.0	260.0	N/A

48P4,P5 055-070 LOW HEAT

HEATING STAGES	INPUT CAPACITY (1000 Btuh)	% FULL FIRE	THERMAL EFFICIENCY %	OUTPUT CAPACITY (1000 Btuh)	OUTPUT CAPACITY PER SECTION (1000 Btuh)		
					SECTION 1	SECTION 2	SECTION 3
1	244	38%	80.0%	195.0	195.0	0.0	N/A
2	325	50%	80.0%	260.0	260.0	0.0	N/A
3	488	75%	80.0%	390.0	195.0	195.0	N/A
4	569	88%	80.0%	455.0	260.0	195.0	N/A
5	650	100%	80.0%	520.0	260.0	260.0	N/A

48P2,P3 055-070 HIGH HEAT

HEATING STAGES	INPUT CAPACITY (1000 Btuh)	% FULL FIRE	THERMAL EFFICIENCY %	OUTPUT CAPACITY (1000 Btuh)	OUTPUT CAPACITY PER SECTION (1000 Btuh)		
					SECTION 1	SECTION 2	SECTION 3
1	244	25%	80.0%	195.0	195.0	0.0	0.0
2	325	33%	80.0%	260.0	260.0	0.0	0.0
3	488	50%	80.0%	390.0	195.0	195.0	0.0
4	569	58%	80.0%	455.0	260.0	195.0	0.0
5	650	67%	80.0%	520.0	260.0	260.0	0.0
6	731	75%	80.0%	585.0	195.0	195.0	195.0
7	813	83%	80.0%	650.0	195.0	260.0	165.0
8	894	92%	80.0%	715.0	260.0	260.0	195.0
9	975	100%	80.0%	780.0	260.0	260.0	260.0

48P4,P5 055-070 HIGH HEAT

HEATING STAGES	INPUT CAPACITY (1000 Btuh)	% FULL FIRE	THERMAL EFFICIENCY %	OUTPUT CAPACITY (1000 Btuh)	OUTPUT CAPACITY PER SECTION (1000 Btuh)		
					SECTION 1	SECTION 2	SECTION 3
1	244	25%	80.0%	195.0	195.0	0.0	0.0
2	325	33%	80.0%	260.0	260.0	0.0	0.0
3	488	50%	80.0%	390.0	195.0	195.0	0.0
4	569	58%	80.0%	455.0	260.0	195.0	0.0
5	650	67%	80.0%	520.0	260.0	260.0	0.0
6	731	75%	80.0%	585.0	195.0	195.0	195.0
7	813	83%	80.0%	650.0	195.0	260.0	195.0
8	894	92%	80.0%	715.0	260.0	260.0	195.0
9	975	100%	80.0%	780.0	260.0	260.0	260.0

48P2,P3 075-100 LOW HEAT

HEATING STAGES	INPUT CAPACITY (1000 Btuh)	% FULL FIRE	THERMAL EFFICIENCY %	OUTPUT CAPACITY (1000 Btuh)	OUTPUT CAPACITY PER SECTION (1000 Btuh)		
					SECTION 1	SECTION 2	SECTION 3
1	244	38%	80.0%	195.0	195.0	0.0	N/A
2	325	50%	80.0%	260.0	260.0	0.0	N/A
3	488	75%	80.0%	390.0	195.0	195.0	N/A
4	569	88%	80.0%	455.0	260.0	195.0	N/A
5	650	100%	80.0%	520.0	260.0	260.0	N/A

Ratings and capacities (cont)



GAS HEATING CAPACITIES — UNITS WITH STAGED GAS CONTROL OPTION (cont)

48P4,P5 075-100 LOW HEAT

HEATING STAGES	INPUT CAPACITY (1000 Btuh)	% FULL FIRE	THERMAL EFFICIENCY %	OUTPUT CAPACITY (1000 Btuh)	OUTPUT CAPACITY PER SECTION (1000 Btuh)		
					SECTION 1	SECTION 2	SECTION 3
1	244	38%	80.0%	195.0	195.0	0.0	N/A
2	325	50%	80.0%	260.0	260.0	0.0	N/A
3	488	75%	80.0%	390.0	195.0	195.0	N/A
4	569	88%	80.0%	455.0	260.0	195.0	N/A
5	650	100%	80.0%	520.0	260.0	260.0	N/A

48P2,P3 075-100 HIGH HEAT

HEATING STAGES	INPUT CAPACITY (1000 Btuh)	% FULL FIRE	THERMAL EFFICIENCY %	OUTPUT CAPACITY (1000 Btuh)	OUTPUT CAPACITY PER SECTION (1000 Btuh)		
					SECTION 1	SECTION 2	SECTION 3
1	244	25%	80.0%	195.0	195.0	0.0	0.0
2	325	33%	80.0%	260.0	260.0	0.0	0.0
3	488	50%	80.0%	390.0	195.0	195.0	0.0
4	569	58%	80.0%	455.0	260.0	195.0	0.0
5	650	67%	80.0%	520.0	260.0	260.0	0.0
6	731	75%	80.0%	585.0	195.0	195.0	195.0
7	813	83%	80.0%	650.0	195.0	260.0	165.0
8	894	92%	80.0%	715.0	260.0	260.0	195.0
9	975	100%	80.0%	780.0	260.0	260.0	260.0

48P4,P5 075-100 HIGH HEAT

HEATING STAGES	INPUT CAPACITY (1000 Btuh)	% FULL FIRE	THERMAL EFFICIENCY %	OUTPUT CAPACITY (1000 Btuh)	OUTPUT CAPACITY PER SECTION (1000 Btuh)		
					SECTION 1	SECTION 2	SECTION 3
1	244	25%	80.0%	195.0	195.0	0.0	0.0
2	325	33%	80.0%	260.0	260.0	0.0	0.0
3	488	50%	80.0%	390.0	195.0	195.0	0.0
4	569	58%	80.0%	455.0	260.0	195.0	0.0
5	650	67%	80.0%	520.0	260.0	260.0	0.0
6	731	75%	80.0%	585.0	195.0	195.0	195.0
7	813	83%	80.0%	650.0	195.0	260.0	195.0
8	894	92%	80.0%	715.0	260.0	260.0	195.0
9	975	100%	80.0%	780.0	260.0	260.0	260.0

GAS HEATING CAPACITIES — UNITS WITH MODULATING GAS CONTROL OPTION

48P2,P3 030-050 LOW HEAT

GAS INPUT (1000 Btuh)	PERCENT FULL FIRE	OUTPUT CAPACITY (1000 Btuh)	FIRING STAGE		
			1	2	3
92 - 325	28 - 100%	68 - 263	Modulating	—	—

48P4,P5 030-050 LOW HEAT

GAS INPUT (1000 Btuh)	PERCENT FULL FIRE	OUTPUT CAPACITY (1000 Btuh)	FIRING STAGE		
			1	2	3
92 - 325	28 - 100%	68 - 260	Modulating	—	—

48P2,P3 030-050 HIGH HEAT

GAS INPUT (1000 Btuh)	PERCENT FULL FIRE	OUTPUT CAPACITY (1000 Btuh)	FIRING STAGE		
			1	2	3
92 - 325	14 - 50%	68 - 256	Modulating	0	—
335 - 569	52 - 88%	265 - 455	Modulating	LF	—
416 - 650	64 - 100%	333 - 527	Modulating	HF	—

LEGEND

HF — High Fire
LF — Low Fire



GAS HEATING CAPACITIES — UNITS WITH MODULATING GAS CONTROL OPTION (cont)

48P4,P5 030-050 HIGH HEAT

GAS INPUT (1000 Btuh)	PERCENT FULL FIRE	OUTPUT CAPACITY (1000 Btuh)	FIRING STAGE		
			1	2	3
92 - 325	14 - 50%	68 - 256	Modulating	0	—
335 - 569	52 - 88%	265 - 455	Modulating	LF	—
416 - 650	64 - 100%	333 - 520	Modulating	HF	—

48P2,P3 055-070 LOW HEAT

GAS INPUT (1000 Btuh)	PERCENT FULL FIRE	OUTPUT CAPACITY (1000 Btuh)	FIRING STAGE		
			1	2	3
92 - 325	14 - 50%	68 - 256	Modulating	0	—
335 - 569	52 - 88%	265 - 455	Modulating	LF	—
416 - 650	64 - 100%	333 - 525	Modulating	HF	—

48P4,P5 055-070 LOW HEAT

GAS INPUT (1000 Btuh)	PERCENT FULL FIRE	OUTPUT CAPACITY (1000 Btuh)	FIRING STAGE		
			1	2	3
92 - 325	14 - 50%	68 - 256	Modulating	0	—
335 - 569	52 - 88%	265 - 455	Modulating	LF	—
416 - 650	64 - 100%	333 - 520	Modulating	HF	—

48P2,P3 055-070 HIGH HEAT

GAS INPUT (1000 Btuh)	PERCENT FULL FIRE	OUTPUT CAPACITY (1000 Btuh)	FIRING STAGE		
			1	2	3
92 - 325	9 - 33%	68 - 256	Modulating	0	0
335 - 569	34 - 58%	265 - 455	Modulating	LF	0
416 - 650	43 - 67%	333 - 520	Modulating	HF	0
579 - 813	59 - 83%	463 - 650	Modulating	LF	LF
660 - 894	68 - 92%	528 - 721	Modulating	HF	LF
741 - 975	76 - 100%	593 - 787	Modulating	HF	HF

48P4,P5 055-070 HIGH HEAT

GAS INPUT (1000 Btuh)	PERCENT FULL FIRE	OUTPUT CAPACITY (1000 Btuh)	FIRING STAGE		
			1	2	3
92 - 325	9 - 33%	68 - 256	Modulating	0	0
335 - 569	34 - 58%	265 - 455	Modulating	LF	0
416 - 650	43 - 67%	333 - 520	Modulating	HF	0
579 - 813	59 - 83%	463 - 650	Modulating	LF	LF
660 - 894	68 - 92%	528 - 721	Modulating	HF	LF
741 - 975	76 - 100%	593 - 780	Modulating	HF	HF

48P2,P3 075-100 LOW HEAT

GAS INPUT (1000 Btuh)	PERCENT FULL FIRE	OUTPUT CAPACITY (1000 Btuh)	FIRING STAGE		
			1	2	3
92 - 325	14 - 50%	68 - 256	Modulating	0	—
335 - 569	52 - 88%	265 - 455	Modulating	LF	—
416 - 650	64 - 100%	333 - 526	Modulating	HF	—

48P4,P5 075-100 LOW HEAT

GAS INPUT (1000 Btuh)	PERCENT FULL FIRE	OUTPUT CAPACITY (1000 Btuh)	FIRING STAGE		
			1	2	3
92 - 325	14 - 50%	68 - 256	Modulating	0	—
335 - 569	52 - 88%	265 - 455	Modulating	LF	—
416 - 650	64 - 100%	333 - 520	Modulating	HF	—

LEGEND

HF — High Fire
LF — Low Fire

Ratings and capacities (cont)



GAS HEATING CAPACITIES — UNITS WITH MODULATING GAS CONTROL OPTION (cont)

48P2,P3 075-100 HIGH HEAT

GAS INPUT (1000 Btuh)	PERCENT FULL FIRE	OUTPUT CAPACITY (1000 Btuh)	FIRING STAGE		
			1	2	3
92 - 325	9 - 33%	68 - 256	Modulating	0	0
335 - 569	34 - 58%	265 - 455	Modulating	LF	0
416 - 650	43 - 67%	333 - 520	Modulating	HF	0
579 - 813	59 - 83%	463 - 650	Modulating	LF	LF
660 - 894	68 - 92%	528 - 719	Modulating	HF	LF
741 - 975	76 - 100%	593 - 784	Modulating	HF	HF

48P4,P5 075-100 HIGH HEAT

GAS INPUT (1000 Btuh)	PERCENT FULL FIRE	OUTPUT CAPACITY (1000 Btuh)	FIRING STAGE		
			1	2	3
92 - 325	9 - 33%	68 - 256	Modulating	0	0
335 - 569	34 - 58%	265 - 455	Modulating	LF	0
416 - 650	43 - 67%	333 - 520	Modulating	HF	0
579 - 813	59 - 83%	463 - 650	Modulating	LF	LF
660 - 894	68 - 92%	528 - 715	Modulating	HF	LF
741 - 975	76 - 100%	593 - 780	Modulating	HF	HF

LEGEND

HF — High Fire
LF — Low Fire

ELECTRIC HEATER CAPACITIES

UNIT SIZE	NO. STAGES	LOW (kW)	CAPACITY PER STAGE (%)	MED (kW)	CAPACITY PER STAGE (%)	HIGH (kW)	CAPACITY PER STAGE (%)	MIN CFM	MAX CFM
50P2,P3030-050									
208 v	2	29	50,100	59	50,100	88	67,100	9,000	20,000
230 v	2	36	50,100	72	50,100	108	67,100	9,000	20,000
380 v	2	25	50,100	51	50,100	76	67,100	9,000	20,000
460 v	2	36	50,100	72	50,100	108	67,100	9,000	20,000
575 v	2	36	50,100	72	50,100	108	67,100	9,000	20,000
50P2,P3055-070									
208 v	2	29	50,100	59	50,100	88	67,100	15,000	30,000
230 v	2	36	50,100	72	50,100	108	67,100	15,000	30,000
380 v	2	25	50,100	51	50,100	76	67,100	15,000	30,000
460 v	2	36	50,100	72	50,100	108	67,100	15,000	30,000
575 v	2	36	50,100	72	50,100	108	67,100	15,000	30,000
50P2,P3,P4,P5075-100									
460 v	2	—	—	108	67,100	216	50,100	15,000	44,000

NOTES:

1. Electric heat options are NOT AVAILABLE on discharge plenum units or size 030-070 horizontal units.
2. Electric heat is available on horizontal size 075-100 units with airfoil fan option only.

CAPACITY CONTROL STAGING SEQUENCES

SIZES 030,035

COMP	STAGE			
	0	1*	1	2
	Compressor Status			
A1	OFF	ON	ON	ON
B1	OFF	OFF	OFF	ON
UNIT	Capacity 48/50P			
030	0%	36%	50%	100%
035	0%	38%	50%	100%

*Minimum load valve.

SIZES 030,035 WITH DIGITAL COMPRESSOR

COMP	STAGE		
	0	1	2
	Compressor Status		
A1*	OFF	ON	ON
B1	OFF	OFF	ON
UNIT	Capacity 48/50P		
030	0%	25% to 50%	75% to 100%
035	0%	25% to 50%	75% to 100%

*On units with optional digital scroll compressor, compressor A1 modulates from minimum to maximum capacity to provide increased stages.

SIZE 040 WITH MINIMUM LOAD VALVE

COMP	STAGE				
	0	1*	1	2	3
	Compressor Status				
A1	OFF	ON	ON	ON	ON
B1	OFF	OFF	OFF	ON	ON
B2	OFF	OFF	OFF	OFF	ON
UNIT	Capacity 48/50P				
040	0%	36%	47%	73%	100%

*Minimum load valve.

SIZE 040 WITH DIGITAL COMPRESSOR

COMP	STAGE			
	0	1	2	3
	Compressor Status			
A1*	OFF	ON	ON	ON
B1	OFF	OFF	ON	ON
B2	OFF	OFF	OFF	ON
UNIT	Capacity 48/50P			
040	0%	23% to 47%	50% to 73%	77% to 100%

*On units with optional digital scroll compressor, compressor A1 modulates from minimum to maximum capacity to provide increased stages.

SIZE 040 WITHOUT MINIMUM LOAD VALVE

COMP	STAGE				
	0	1	2	3	4
	Compressor Status				
A1	OFF	OFF	ON	ON	ON
B1	OFF	ON	OFF	ON	ON
B2	OFF	OFF	OFF	OFF	ON
UNIT	Capacity 48/50P				
040	0%	27%	47%	73%	100%

SIZES 050-075

COMP	STAGE					
	0	1*	1	2	3	4
	Compressor Status					
A1	OFF	ON	ON	ON	ON	ON
A2	OFF	OFF	OFF	OFF	ON	ON
B1	OFF	OFF	OFF	ON	ON	ON
B2	OFF	OFF	OFF	OFF	OFF	ON
UNIT	Capacity 48/50P					
050	0%	15%	23%	50%	73%	100%
055	0%	17%	25%	50%	75%	100%
060	0%	18%	25%	50%	75%	100%
070	0%	16%	23%	46%	73%	100%
075	0%	19%	25%	50%	75%	100%

→

*Minimum load valve.

SIZES 050-075 WITH DIGITAL COMPRESSOR

COMP	STAGE				
	0	1	2	3	4
	Compressor Status				
A1*	OFF	ON	ON	ON	ON
A2	OFF	OFF	OFF	ON	ON
B1	OFF	OFF	ON	ON	ON
B2	OFF	OFF	OFF	OFF	ON
UNIT	Capacity 48/50P				
050	0%	12% to 23%	38% to 50%	62% to 73%	88% to 100%
055	0%	13% to 25%	38% to 50%	63% to 75%	88% to 100%
060	0%	13% to 25%	38% to 50%	63% to 75%	88% to 100%
070	0%	11% to 23%	34% to 46%	61% to 73%	89% to 100%
075	0%	13% to 25%	38% to 50%	63% to 75%	88% to 100%

*On units with optional digital scroll compressor, compressor A1 modulates from minimum to maximum capacity to provide increased stages.

Ratings and capacities (cont)



CAPACITY CONTROL STAGING SEQUENCES (cont)

SIZES 090-100

COMP	STAGE							
	0	1*	1	2	3	4	5	6
Compressor Status								
A1	OFF	ON	ON	ON	ON	ON	ON	ON
A2	OFF	OFF	OFF	OFF	ON	ON	ON	ON
A3	OFF	OFF	OFF	OFF	OFF	OFF	ON	ON
B1	OFF	OFF	OFF	ON	ON	ON	ON	ON
B2	OFF	OFF	OFF	OFF	OFF	ON	ON	ON
B3	OFF	OFF	OFF	OFF	OFF	OFF	OFF	ON
Capacity 48/50P								
090	0%	12%	17%	33%	50%	67%	83%	100%
100	0%	11%	15%	33%	49%	67%	82%	100%

*Minimum load valve.

SIZES 090-100 WITH DIGITAL COMPRESSOR

COMP	STAGE							
	0	1	2	3	4	5	6	
Compressor Status								
A1*	OFF	ON	ON	ON	ON	ON	ON	ON
A2	OFF	OFF	OFF	ON	ON	ON	ON	ON
A3	OFF	OFF	OFF	OFF	OFF	ON	ON	ON
B1	OFF	OFF	ON	ON	ON	ON	ON	ON
B2	OFF	OFF	OFF	OFF	ON	ON	ON	ON
B3	OFF	OFF	OFF	OFF	OFF	OFF	OFF	ON
Capacity 48/50P								
090	0%	8% to 17%	25% to 33%	42% to 50%	58% to 67%	75% to 83%	92% to 100%	
100	0%	8% to 15%	26% to 33%	41% to 49%	59% to 67%	74% to 82%	92% to 100%	

*On units with optional digital scroll compressor, compressor A1 modulates from minimum to maximum capacity to provide increased stages.

Physical data — 48 series units



48P2,P3,P4,P5030,035

BASE UNIT	48P2,P3,P4,P5030		48P2,P3,P4,P5035	
NOMINAL CAPACITY (tons)	30		35	
OPERATING WEIGHT (lb)	Standard Chassis	Extended Chassis	Standard Chassis	Extended Chassis
Base Unit				
Low Heat	5310	5810	5410	5910
High Heat	5440	5940	5540	6040
With Economizer				
Low Heat	5610	6110	5710	6210
High Heat	5740	6240	5840	6340
COMPRESSORS	Scroll			
Quantity...Type	1...ZP154/1...ZP154		1...ZP182/1...ZP182	
Oil Charge (oz) per Compressor	110		110	
Number of Refrigerant Circuits	2		2	
REFRIGERANT	R-410A			
Operating Charge (lb), Ckt 1/Ckt 2				
Standard Evaporator Coil	15.4/14.8		18.4/17.6	
Standard Evaporator with Humidi-MiZer® System	15.4/24.9		18.4/27.7	
Alternate High-Capacity Evaporator Coil	17.2/16.0		N/A	
Alternate High-Capacity Evaporator with Humidi-MiZer	17.2/26.1		N/A	
CONDENSER COILS	Aluminum Novation® Heat Exchanger with Microchannel Coils			
Quantity	1		1	
Total Face Area (sq ft)	33.3		33.3	
EVAPORATOR COILS	1			
Quantity			32.1	
Total Face Area (sq ft)			TXV...1	
Refrigerant Feed Device...No. per Circuit				
Standard Evaporator Coils				
Rows...Fins/in.	3...15.0		4...15.0	
Fin Type	Double Wavy		Double Wavy	
Tube Type	Cross Hatched		Cross Hatched	
Alternate, High-Capacity Evaporator Coils				
Rows...Fins/in.	4...15.0		N/A	
Fin Type	Double Wavy		N/A	
Tube Type	Cross Hatched		N/A	
OPTIONAL HUMIDI-MIZER ADAPTIVE DEHUMIDIFICATION SYSTEM	E-Coated Aluminum Novation® Heat Exchanger with Microchannel Coil Technology			
Coil Construction				
Quantity	1		1	
Face Area (sq ft)	26.7		26.7	
OPTIONAL HYDRONIC HEAT COIL	½-in. OD copper tubes, aluminum plate fins, galvanized steel frame			
Face Area (sq ft)	22.6		22.6	
Rows...Fins Per Inch	2...8		2...8	
Circuit Arrangement	Half		Half	
Connections — (Qty) Dim				
Supply (in.)	(1) 2 ½ NPT		(1) 2 ½ NPT	
Return (in.)	(1) 2 ½ NPT		(1) 2 ½ NPT	
Header Material	Steel		Steel	
Internal Volumes (cu ft)	0.5272		0.5272	
HEATING SECTION	Low Heat	High Heat	Low Heat	High Heat
Number of Heat Exchangers	7	14	7	14
Input (MBtuh)	325	650	325	650
Output (MBtuh) (Vertical/Horizontal)	263/260	527/520	263/260	527/520
Temperature Rise Range (F)	10-40	25-55	10-40	25-55
Efficiency (%) (Vertical/Horizontal)	81/80	81/80	81/80	81/80
Burner Orifice Diameter				
Quantity (in. ...drill no.)	7 (.1285...30)	14 (.1285...30)	7 (.1258...30)	14 (.1258...30)
Manifold Pressure (in. wg)	3.5		3.5	
Line Pressure (in. wg) (min...max)	5.0...13.0	5.0...13.0	5.0...13.0	5.0...13.0
Firing Stages	2		2	
Number of Gas Valves	1		1	
CONDENSER FANS	Propeller Type			
Quantity...Diameter (in.)	2...30		2...30	
Nominal Cfm	18,000		19,500	
Motor Hp...Rpm	1.0...1140		1.0...1140	
SUPPLY FAN	Centrifugal 25 x 25 in.			
Nominal Cfm	12,000		14,000	
Maximum Allowable Cfm	15,000		15,000	
Maximum Allowable Rpm	900		900	
Shaft Diameter at Pulley (in.)	1 11/16		1 11/16	
SUPPLY-FAN MOTOR AND DRIVE	(Any motor available on any unit)			
Motor Hp	7.5	10	15	20
Motor Frame Size	213T	215T	254T	256T
Efficiency at Full Load (%)	91.7	91.7	93.0	93.6
Fan Pulley Pitch Diameter (in.)	13.7	13.7	13.7	13.7
Motor Pulley Pitch Diameter (in.)	3.4	4.3	4.9	5.5
Resulting Fan Speed (rpm)	438	549	626	703
Belts Quantity...Type	2...BX60		2...5VX630	
Center Distance Range (in.)	17.74-14.30	17.74-14.30	17.63...14.01	17.63...14.01

LEGEND

MBtuh — Btuh in Thousands
 TXV — Thermostatic Expansion Valve

Physical data — 48 series units (cont)



48P2,P3,P4,P5030,035 (cont)

BASE UNIT	48P2,P3,P4,P5030		48P2,P3,P4,P5035	
NOMINAL CAPACITY (tons)	30		35	
OPTIONAL POWER EXHAUST	Centrifugal, 18 x 15 in. (Any motor available on any unit)			
Quantity...Motor Hp	2...3.0	2...5.0	2...7.5	2...10
Motor Frame Size	182T	184T	213T	215T
Efficiency at Full Load (%)	88.5	89.5	91.7	91.7
Fan Pulley Pitch Diameter (in.)	11.0	10.4	12	12
Motor Pulley Pitch Diameter Range (in.)	4.1-3.1	4.7-3.7	6.0-4.8	7.0-5.8
Motor Pulley Pitch Diameter Factory Setup (in.)	4.1	4.2	5.4	6.4
Blower Shaft Diameter at Pulley (in.)	17/16	17/16	17/16	17/16
Fan Rpm Range	500-656	621-785	717-882	854-1000
Factory Setup Fan Rpm	656	703	800	927
Maximum Allowable Rpm	1000	1000	1000	1000
FILTERS				
Standard Efficiency Throwaway (Standard)				
Quantity...Size (in.)	8...20 x 25 x 2, 8...20 x 20 x 2		8...20 x 25 x 2, 8...20 x 20 x 2	
Medium Efficiency (30%) Pleated (Optional)				
Quantity...Size (in.)	8...20 x 25 x 2, 8...20 x 20 x 2		8...20 x 25 x 2, 8...20 x 20 x 2	
High Efficiency (90%) Bag Filters with High Velocity Prefilters (Opt)				
Quantity...Size (in.)	6...20 x 24 x 22, 6...20 x 20 x 22		6...20 x 24 x 22, 6...20 x 20 x 22	
Bag Filter Prefilter	12...16 x 20 x 2, 3...20 x 24 x 2		12...16 x 20 x 2, 3...20 x 24 x 2	
Cartridge Filters with High Velocity Prefilters (Opt)				
Quantity...Size (in.)	6...20 x 24 x 12, 6...20 x 20 x 12		6...20 x 24 x 12, 6...20 x 20 x 12	
Cartridge Filter Prefilter	12...16 x 20 x 2, 3...20 x 24 x 2		12...16 x 20 x 2, 3...20 x 24 x 2	
OUTSIDE AIR SCREENS				
Standard Hood (25%) Quantity...Size (in.)	None		None	
OPTIONAL ECONOMIZER FILTER	Aluminum Frame, Permanent			
Quantity...Size (in.)	5...20 x 20 x 2 2...20 x 25 x 1		5...20 x 20 x 1 2...20 x 25 x 1	

LEGEND

MBtuh — Btuh in Thousands
TXV — Thermostatic Expansion Valve

48P2,P3,P4,P5040,050

BASE UNIT	48P2,P3,P4,P5040		48P2,P3,P4,P5050			
NOMINAL CAPACITY (tons)	40		50			
OPERATING WEIGHT (lb)	Standard Chassis	Extended Chassis	Standard Chassis	Extended Chassis		
Base Unit						
Low Heat	5810	6310	6025	6525		
High Heat	5940	6440	6155	6655		
With Economizer						
Low Heat	6110	6610	6325	6825		
High Heat	6240	6740	6455	6955		
COMPRESSORS	Scroll					
Quantity...Type	2...ZP103/1...ZP182		2...ZP120/2...ZP137			
Oil Charge (oz) per Compressor	110		110			
Number of Refrigerant Circuits	2		2			
REFRIGERANT	R-410A					
Operating Charge (lb), Ckt 1/Ckt 2						
Standard Evaporator Coil	21.6/26.7		29.4/29.0			
Standard Evaporator with Humidi-MiZer® System	21.6/39.1		29.4/41.4			
Alternate High-Capacity Evaporator Coil	31.1/37.2		35.2/36.5			
Alternate High-Capacity Evaporator with Humidi-MiZer	31.1/49.6		35.2/48.9			
CONDENSER COILS	Aluminum Novation® Heat Exchanger with Microchannel Coils					
Quantity	2		2			
Total Face Area (sq ft)	66.7		66.7			
EVAPORATOR COILS	2 45.5 TXV...2					
Quantity						
Total Face Area (sq ft)						
Refrigerant Feed Device...No. per Circuit						
Standard Evaporator Coils						
Rows...Fins/in.	3...15.0		4...15.0			
Fin Type	Double Wavy		Double Wavy			
Tube Type	Cross Hatched		Cross Hatched			
Alternate, High-Capacity Evaporator Coils						
Rows...Fins/in.	6...16.0		6...16.0			
Fin Type	Double Wavy		Double Wavy			
Tube Type	Cross Hatched		Cross Hatched			
OPTIONAL HUMIDI-MIZER ADAPTIVE DEHUMIDIFICATION SYSTEM	E-Coated Aluminum Novation® Heat Exchanger with Microchannel Coil Technology					
Coil Construction						
Quantity	1		1			
Face Area (sq ft)	26.7		26.7			
OPTIONAL HYDRONIC HEAT COIL	½-in. OD copper tubes, aluminum plate fins, galvanized steel frame					
Face Area (sq ft)	22.6		22.6			
Rows...Fins Per Inch	2...8		2...8			
Circuit Arrangement	Half		Half			
Connections — (Qty) Dim						
Supply (in.)	(1) 2 ½ NPT		(1) 2 ½ NPT			
Return (in.)	(1) 2 ½ NPT		(1) 2 ½ NPT			
Header Material	Steel		Steel			
Internal Volumes (cu ft)	0.5272		0.5272			
HEATING SECTION	Low Heat	High Heat	Low Heat	High Heat		
Number of Heat Exchangers	7	14	7	14		
Input (MBtuh)	325	650	325	650		
Output (MBtuh) (Vertical/Horizontal)	263/260	527/520	263/260	527/520		
Temperature Rise Range (F)	10-40	25-55	10-40	25-55		
Efficiency (%) (Vertical/Horizontal)	81/80	81/80	81/80	81/80		
Burner Orifice Diameter						
Quantity (in. ...drill no.)	7 (.1285...30)	14 (.1285...30)	7 (.1285...30)	14 (.1285...30)		
Manifold Pressure (in. wg)	3.5		3.5			
Line Pressure (in. wg) (min...max)	5.0...13.0		5.0...13.0			
Firing Stages	2		2			
Number of Gas Valves	1		1			
CONDENSER FANS	Propeller Type					
Quantity...Diameter (in.)	3...30		4...30			
Nominal Cfm	30,000		38,000			
Motor Hp...Rpm	1.0...1140		1.0...1140			
SUPPLY FAN	Centrifugal 25 x 25 in.					
Nominal Cfm	16,000		20,000			
Maximum Allowable Cfm	20,000		20,000			
Maximum Allowable Rpm	900		900			
Shaft Diameter at Pulley (in.)	1 11/16		1 11/16			
SUPPLY-FAN MOTOR AND DRIVE	(Any motor available on any unit)					
Motor Hp	7.5	10	15	20	25	30*
Motor Frame Size	213T	215T	254T	256T	284T	286T
Efficiency at Full Load (%)	91.7	91.7	93.0	93.6	93.6	93.6
Fan Pulley Pitch Diameter (in.)	13.7	13.7	13.7	13.7	13.7	12.5
Motor Pulley Pitch Diameter (in.)	3.4	4.3	4.9	5.5	6.5	6.5
Resulting Fan Speed (rpm)	438	549	626	703	830	910
Belts Quantity...Type	2...BX60		2...5VX630		2...5VX630	
Center Distance Range (in.)	17.74-14.30	17.74-14.30	17.63...14.01	17.63...14.01	16.63...12.87	16.63...12.87

LEGEND

MBtuh — Btuh in Thousands
 TXV — Thermostatic Expansion Valve

* 460-3-60 only.

Physical data — 48 series units (cont)



48P2,P3,P4,P5040,050 (cont)

BASE UNIT	48P2,P3,P4,P5040		48P2,P3,P4,P5050	
NOMINAL CAPACITY (tons)	40		50	
OPTIONAL POWER EXHAUST	Centrifugal, 18 x 15 in. (Any motor available on any unit)			
Quantity...Motor Hp	2...3.0	2...5.0	2...7.5	2...10
Motor Frame Size	182T	184T	213T	215T
Efficiency at Full Load (%)	88.5	89.5	91.7	91.7
Fan Pulley Pitch Diameter (in.)	11.0	10.4	12	12
Motor Pulley Pitch Diameter Range (in.)	4.1-3.1	4.7-3.7	6.0-4.8	7.0-5.8
Motor Pulley Pitch Diameter Factory Setup (in.)	4.1	4.2	5.4	6.4
Blower Shaft Diameter at Pulley (in.)	17/16	17/16	17/16	17/16
Fan Rpm Range	500-656	621-785	717-882	854-1000
Factory Setup Fan Rpm	656	703	800	927
Maximum Allowable Rpm	1000	1000	1000	1000
FILTERS				
Standard Efficiency Throwaway (Standard)				
Quantity...Size (in.)	8...20 x 25 x 2, 8...20 x 20 x 2		8...20 x 25 x 2, 8...20 x 20 x 2	
Medium Efficiency (30%) Pleated (Optional)				
Quantity...Size (in.)	8...20 x 25 x 2, 8...20 x 20 x 2		8...20 x 25 x 2, 8...20 x 20 x 2	
High Efficiency (90%) Bag Filters with High Velocity Prefilters (Opt)				
Quantity...Size (in.)	6...20 x 24 x 22, 6...20 x 20 x 22		6...20 x 24 x 22, 6...20 x 20 x 22	
Bag Filter Prefilter	12...16 x 20 x 2, 3...20 x 24 x 2		12...16 x 20 x 2, 3...20 x 24 x 2	
Cartridge Filters with High Velocity Prefilters (Opt)				
Quantity...Size (in.)	6...20 x 24 x 12, 6...20 x 20 x 12		6...20 x 24 x 12, 6...20 x 20 x 12	
Cartridge Filter Prefilter	12...16 x 20 x 2, 3...20 x 24 x 2		12...16 x 20 x 2, 3...20 x 24 x 2	
OUTSIDE AIR SCREENS				
Standard Hood (25%) Quantity...Size (in.)	None		None	
OPTIONAL ECONOMIZER FILTER	Aluminum Frame, Permanent			
Quantity...Size (in.)	5...20 x 20 x 2 2...20 x 25 x 1		5...20 x 20 x 1 2...20 x 25 x 1	

LEGEND

MBtuh — Btuh in Thousands
TXV — Thermostatic Expansion Valve

48P2,P3,P4,P5055-070

BASE UNIT	48P2,P3,P4,P5055		48P2,P3,P4,P5060		48P2,P3,P4,P5070	
NOMINAL CAPACITY (tons)	55		60		70	
OPERATING WEIGHT (lb)	Standard Chassis	Extended Chassis	Standard Chassis	Extended Chassis	Standard Chassis	Extended Chassis
Base Unit						
Low Heat	7810	8360	7865	8415	8205	8755
High Heat	7940	8490	7995	8545	8335	8885
With Economizer						
Low Heat	8340	8890	8395	8945	8735	9285
High Heat	8470	9020	8525	9075	8865	9415
COMPRESSORS	Scroll					
Quantity...Type	2...ZP137/2...ZP137		2...ZP154/2...ZP154		1...ZP154,1...ZP182/ 1...ZP154,1...ZP182	
Oil Charge (oz) per Compressor	110		110		110	
Number of Refrigerant Circuits	2		2		2	
REFRIGERANT	R-410A					
Operating Charge (lb), Ckt 1/Ckt 2						
Standard Evaporator Coil	37.6/37.9		37.6/37.9		39.5/42.0	
Standard Evaporator with Humidi-MiZer® System	37.6/50.3		37.6/50.3		39.5/54.4	
Alternate High-Capacity Evaporator Coil	43.5/42.8		44.6/43.5		49.0/50.0	
Alternate High-Capacity Evaporator with Humidi-MiZer	43.5/55.2		44.6/55.9		49.0/62.4	
CONDENSER COILS	Aluminum Novation® Heat Exchanger with Microchannel Coils					
Quantity	2		2		4	
Total Face Area (sq ft)	66.7		66.7		106.7	
EVAPORATOR COILS	2					
Quantity	2					
Total Face Area (sq ft)	61.5					
Refrigerant Feed Device...No. per Circuit	TXV...2					
Standard Evaporator Coils						
Rows...Fins/in.	4...15		4...15		4...15	
Fin Type	Double Wavy		Double Wavy		Double Wavy	
Tube Type	Cross Hatched		Cross Hatched		Cross Hatched	
Alternate, High-Capacity Evaporator Coils						
Rows...Fins/in.	6...16		6...16		6...16	
Fin Type	Double Wavy		Double Wavy		Double Wavy	
Tube Type	Cross Hatched		Cross Hatched		Cross Hatched	
OPTIONAL HUMIDI-MIZER ADAPTIVE DEHUMIDIFICATION SYSTEM	E-Coated Aluminum Novation® Heat Exchanger with Microchannel Coil Technology					
Coil Construction	1					
Quantity	1		1		1	
Face Area (sq ft)	26.7	26.7	26.7	26.7	26.7	26.7
OPTIONAL HYDRONIC HEAT COIL	½-in. OD copper tubes, aluminum plate fins, galvanized steel frame					
Face Area (sq ft)	(2) sections: total 27.1		(2) sections: total 27.1		(2) sections: total 27.1	
Rows...Fins Per Inch	2...11		2...11		2...11	
Circuit Arrangement	Half		Half		Half	
Connections — (Qty) Dim						
Supply (in.)	(2) 1 ½ NPT		(2) 1 ½ NPT		(2) 1 ½ NPT	
Return (in.)	(2) 1 ½ NPT		(2) 1 ½ NPT		(2) 1 ½ NPT	
Header Material	Steel					
Internal Volumes (cu ft)	0.6327		0.6327		0.6327	
HEATING SECTION	Low Heat	High Heat	Low Heat	High Heat	Low Heat	High Heat
Number of Heat Exchangers	14	21	14	21	14	21
Input (MBtuh)	650	975	650	975	650	975
Output (MBtuh) (Vertical/Horizontal)	525/520	787/780	525/520	787/780	525/520	787/780
Temperature Rise Range (F)	10-40	20-50	10-40	20-50	10-40	20-50
Efficiency (%) (Vertical/Horizontal)	81/80	81/80	81/80	81/80	81/80	81/80
Burner Orifice Diameter						
Quantity (in. ...drill no.)	14 (.1285...30)	21 (.1285...30)	14 (.1285...30)	21 (.1285...30)	14 (.1285...30)	21 (.1285...30)
Manifold Pressure (in. wg)	3.5	3.5	3.5	3.5	3.5	3.5
Line Pressure (in. wg) (min...max)	5.0...13.0	5.0...13.0	5.0...13.0	5.0...13.0	5.0...13.0	5.0...13.0
Firing Stages	2	2	2	2	2	2
Number of Gas Valves	2	3	2	3	2	3
CONDENSER FANS	Propeller Type					
Quantity...Diameter (in.)	4...30		4...30		4...30	
Nominal Cfm	36,000		36,600		39,000	
Motor Hp...Rpm	1.0...1140		1.0...1140		1.0...1140	
SUPPLY FAN	Centrifugal 30 x 27.5 in.					
Nominal Cfm	22,000		24,000		28,000	
Maximum Allowable Cfm	25,000		30,000		30,000	
Maximum Allowable Rpm	800		800		800	
Shaft Diameter at Pulley (in.)	1 11/16		1 11/16		1 11/16	
SUPPLY-FAN MOTOR AND DRIVE	(Any motor available on any unit)					
Motor Hp	15		20		30	
Motor Frame Size	254T		256T		284T	
Efficiency at Full Load (%)	93.0		93.6		93.6	
Fan Pulley Pitch Diameter (in.)	13.7		13.7		13.7	
Motor Pulley Pitch Diameter (in.)	4.5		5.1		5.5	
Resulting Fan Speed (rpm)	575		651		703	
Belts Quantity...Type	2...5VX1230		2...5VX1230		2...5VX1230	
Center Distance Range (in.)	48.25-44.00		48.25-44.00		48.50-44.25	
OPTIONAL POWER EXHAUST	Centrifugal, 18 x 15 in. (Any motor available on any unit)					
Quantity...Motor Hp	2...5		2...7.5		2...10	
Motor Frame Size	184T		213T		215T	
Efficiency at Full Load (%)	89.5		91.7		91.7	
Resulting Fan Rpm	740		820		920	
Maximum Allowable Rpm	1000		1000		1000	

LEGEND

MBtuh — Btuh in Thousands
 TXV — Thermostatic Expansion Valve

Physical data — 48 series units (cont)



48P2,P3,P4,P5055-070 (cont)

BASE UNIT	48P2,P3,P4,P5055	48P2,P3,P4,P5060	48P2,P3,P4,P5070
NOMINAL CAPACITY (tons)	55	60	70
FILTERS			
Standard Efficiency Throwaway (Standard)			
Quantity...Size (in.)	12...20 x 25 x 2, 12...20 x 20 x 2	12...20 x 25 x 2, 12...20 x 20 x 2	12...20 x 25 x 2, 12...20 x 20 x 2
Medium Efficiency (30%) Pleated (Optional)			
Quantity...Size (in.)	12...20 x 25 x 2, 12...20 x 20 x 2	12...20 x 25 x 2, 12...20 x 20 x 2	12...20 x 25 x 2, 12...20 x 20 x 2
High Efficiency (90%) Bag Filters with High Velocity Prefilters (Optional)			
Quantity...Size (in.)	6...24 x 24 x 22, 6...24 x 20 x 22	6...24 x 24 x 22, 6...24 x 20 x 22	6...24 x 24 x 22, 6...24 x 20 x 22
Bag Filter	6...24 x 24 x 2, 6...20 x 24 x 2	6...24 x 24 x 2, 6...20 x 24 x 2	6...24 x 24 x 2, 6...20 x 24 x 2
Cartridge Filters with High Velocity Prefilters (Optional)			
Quantity...Size (in.)	6...24 x 24 x 12, 6...24 x 20 x 12	6...24 x 24 x 12, 6...24 x 20 x 12	6...24 x 24 x 12, 6...24 x 20 x 12
Cartridge Filter	6...24 x 24 x 2, 6...20 x 24 x 2	6...24 x 24 x 2, 6...20 x 24 x 2	6...24 x 24 x 2, 6...20 x 24 x 2
Prefilter			
OUTSIDE AIR SCREENS			
Standard Hood (25%) Quantity...Size (in.)	4...25 x 16 x 1, 2...20 x 16 x 1	4...25 x 16 x 1, 2...20 x 16 x 1	4...25 x 16 x 1, 2...20 x 16 x 1
OPTIONAL ECONOMIZER FILTER		Aluminum Frame, Permanent	
Quantity...Size (in.)	12...16 x 25 x 1, 2...16 x 20 x 1	12...16 x 25 x 1, 2...16 x 20 x 1	12...16 x 25 x 1, 2...16 x 20 x 1

LEGEND

MBtuh — Btuh in Thousands
TXV — Thermostatic Expansion Valve

48P2,P3,P4,P5075-100

BASE UNIT	48P2,P3,P4,P5075		48P2,P3,P4,P5090		48P2,P3,P4,P5100	
NOMINAL CAPACITY (tons)	75		90		100	
OPERATING WEIGHT (lb)	Standard Chassis	Extended Chassis	Standard Chassis	Extended Chassis	Standard Chassis	Extended Chassis
Base Unit						
Low Heat	9065	9615	9665	10,215	9685	10,235
High Heat	9195	9745	9795	10,345	9815	10,365
With Economizer						
Low Heat	9595	10,145	10,195	10,745	10,215	10,765
High Heat	9725	10,275	10,325	10,875	10,345	10,895
COMPRESSORS	Scroll					
Quantity...Type	2...ZP182/2...ZP182		3...ZP154,3...ZP154		3...ZP154,3...ZP182	
Oil Charge (oz) per Compressor	110		110		110	
Number of Refrigerant Circuits	2		2		2	
REFRIGERANT	R-410A					
Operating Charge (lb), Ckt 1/Ckt 2						
Standard Evaporator Coil	39.5/42.0		50.4/51.3		50.8/52.8	
Standard Evaporator with Humidi-MiZer® System	39.5/54.4		50.4/69.1		50.8/70.6	
Alternate High-Capacity Evaporator Coil	49.0/50.0		61.5/62.9		59.3/62.8	
Alternate High-Capacity Evaporator with Humidi-MiZer	49.0/62.4		61.5/80.7		59.3/80.6	
CONDENSER COILS	Aluminum Novation® Heat Exchanger with Microchannel Coils					
Quantity	4		6		6	
Total Face Area (sq ft)	106.7		160.0		160.0	
EVAPORATOR COILS	2					
Quantity	61.5					
Total Face Area (sq ft)	TXV...2					
Refrigerant Feed Device...No. per Circuit						
Standard Evaporator Coils						
Rows...Fins/in.	4...15		4...15		4...15	
Fin Type	Double Wavy		Double Wavy		Double Wavy	
Tube Type	Cross Hatched		Cross Hatched		Cross Hatched	
Alternate, High-Capacity Evaporator Coils						
Rows...Fins/in.	6...16		6...16		6...16	
Fin Type	Double Wavy		Double Wavy		Double Wavy	
Tube Type	Cross Hatched		Cross Hatched		Cross Hatched	
OPTIONAL HUMIDI-MIZER® ADAPTIVE DEHUMIDIFICATION SYSTEM	E-Coated Aluminum Novation® Heat Exchanger with Microchannel Coil Technology					
Coil Construction						
Quantity	1		1		1	
Face Area (sq ft)	26.7		33.3		33.3	
OPTIONAL HYDRONIC HEAT COIL	½-in. OD copper tubes, aluminum plate fins, galvanized steel frame					
Face Area (sq ft)	(2) sections: total 27.1		(2) sections: total 27.1		(2) sections: total 27.1	
Rows...Fins Per Inch	2...11		2...11		2...11	
Circuit Arrangement	Half		Half		Half	
Connections — (Qty) Dim						
Supply (in.)	(2) 1 ½ NPT		(2) 1 ½ NPT		(2) 1 ½ NPT	
Return (in.)	(2) 1 ½ NPT		(2) 1 ½ NPT		(2) 1 ½ NPT	
Header Material	Steel		Steel		Steel	
Internal Volumes (cu ft)	0.6327		0.6327		0.6327	
HEATING SECTION	Low Heat	High Heat	Low Heat	High Heat	Low Heat	High Heat
Number of Heat Exchangers	2	3	2	3	2	3
Input (MBtuh)	650	975	650	975	650	975
Output (MBtuh) (Vertical/Horizontal)	526/520	784/780	526/520	784/780	526/520	784/780
Temperature Rise Range (F)	10-40	20-50	10-40	20-50	10-40	20-50
Efficiency (%) (Vertical/Horizontal)	81/80	81/80	81/80	81/80	81/80	81/80
Burner Orifice Diameter						
Quantity (in. ...drill no.)	7 (.1285...30)	7 (.1285...30)	7 (.1285...30)	7 (.1285...30)	7 (.1285...30)	7 (.1285...30)
Manifold Pressure (in. wg)	3.5	3.5	3.5	3.5	3.5	3.5
Line Pressure (in. wg) (Min...Max)	5.0...13.0	5.0...13.0	5.0...13.0	5.0...13.0	5.0...13.0	5.0...13.0
Number of Gas Valves	2	3	2	3	2	3
CONDENSER FAN	Propeller Type					
Quantity...Diameter (in.)	4...30		6...30		6...30	
Nominal Cfm	39,000		58,000		58,000	
Motor Hp (ea)...rpm	1.0...1140		1.0...1140		1.0...1140	
STANDARD SUPPLY FAN	Forward Curved Centrifugal 36 x 30 in.					
Nominal Cfm	30,000		36,000		40,000	
Maximum Allowable Cfm	30,000		36,000		40,000	
Maximum Allowable Rpm	680		680		680	
Shaft Diameter at Pulley (in.)	1 11/16		1 11/16		1 11/16	
STANDARD SUPPLY-FAN MOTOR AND DRIVE	(Any motor available on any unit)					
Motor Hp	30	40	50	60		
Motor Frame Size	S268T	S324T	S326T	S364T		
Efficiency at Full Load (%)	93.6	94.5	94.5	95.4		
Fan Pulley Pitch Diameter (in.)	18.5	18.5	18.5	18.5		
Motor Pulley Pitch Diameter (in.)	5.3	5.7	6.5	7.1		
Resulting Fan Rpm	501	539	615	672		
Belts Quantity...Type	3...5VX1320		4...5VX1320		4...5VX1320	
Center Distance Range (in.)	47.88-45.01		47.64-44.76		47.42-44.52	
ALTERNATE, AIRFOIL FAN	DWDI Airfoil, 33 in.					
Nominal Airflow (cfm)	30,000		36,000		40,000	
Maximum Allowable Airflow (cfm)	30,000		36,000		40,000	
Maximum Allowable Wheel Speed (rpm)	1846		1846		1846	
Shaft Diameter at Pulley (in.)	2 11/16		2 11/16		2 11/16	

LEGEND

- DWDI — Double Width, Double Inlet
- MBtuh — Btuh in Thousands
- SWSI — Single Width, Single Inlet
- TXV — Thermostatic Expansion Valve

Physical data — 48 series units (cont)



48P2,P3,P4,P5075-100 (cont)

BASE UNIT	48P2,P3,P4,P5075	48P2,P3,P4,P5090	48P2,P3,P4,P5100	
ALTERNATE SUPPLY-FAN MOTOR AND DRIVE	(Any motor available on any unit)			
Motor Hp	30	40	50	60
Motor Frame Size	S268T	S324T	S326T	S364T
Efficiency at Full Load (%)	93.6	94.5	94.5	95.4
Fan Pulley Pitch Diameter (in.)	9.7	10.2	8.9	8.9
Motor Pulley Pitch Diameter (in.)	7.5	8.7	8.1	8.7
Resulting Fan Rpm	1353	1493	1593	1711
Belts Quantity...Type	2...5VX1150	2...5VX1180	3...5VX1150	3...5VX1150
Center Distance Range (in.)	42.96...45.82	42.96...45.57	42.96...45.57	42.45...45.35
OPTIONAL RETURN/EXHAUST FAN	SWSI Plenum Fan, 47.13 in. (Any motor available on any unit.)			
Quantity...Motor Hp	1...20	1...25	1...30	1...40
Motor Frame Size	256T	284T	286T	324T
Efficiency at Full Load (%)	93.6	93.6	93.6	93.8
Fan Pulley Pitch Diameter (in.)	8.5	9.8	8.5	8.5
Motor Pulley Pitch Diameter (in.)	5.3	6.7	6.1	6.7
Shaft Diameter at Pulley (in.)	2 ¹⁵ / ₁₆	2 ¹⁵ / ₁₆	2 ¹⁵ / ₁₆	2 ¹⁵ / ₁₆
Resulting Fan Rpm	1104	1209	1271	1396
Maximum Allowable Rpm	1447	1447	1447	1447
OPTIONAL POWER EXHAUST	Centrifugal, 18 x 15 in. (Any motor available on any unit.)			
Quantity...Motor Hp	2...5	2...7.5	2...7.5	2...10
Motor Frame Size	184T	213T	213T	215T
Efficiency at Full Load (%)	89.5	91.7	91.7	91.7
Fan Pulley Pitch Diameter (in.)	10.6	10.6	10.6	10.6
Motor Pulley Pitch Diameter (in.)	4.5	5.0	5.0	5.6
Shaft Diameter at Pulley (in.)	1 ⁷ / ₁₆	1 ⁷ / ₁₆	1 ⁷ / ₁₆	1 ⁷ / ₁₆
Resulting Fan Rpm	740	820	820	920
Maximum Allowable Rpm	1000	1000	1000	1000
OPTIONAL HIGH-CAPACITY POWER EXHAUST	Centrifugal, 22 x 20 in., 1 ¹¹ / ₁₆ in. shaft diameter (Any motor available on any unit)			
Total Hp	20	30	40	50
Quantity...Motor Hp	2...10	2...15	2...20	2...25
Motor Frame Size	S215T	D254T	S256T	S284T
Efficiency at Full Load (%)	91.7	93.0	93.6	93.6
Fan Sheave Pitch Diameter (in.)	12.4	12.4	11.1	11.1
Motor Sheave Pitch Diameter (in.)	4.8	5.8	5.9	6.5
Resulting Fan Rpm	714	841	928	1020
Maximum Allowable Rpm	1175	1175	1175	1175
Belts Quantity...Type	2...BX93	2...BX93	2...5VX950	2...5VX950
FILTERS				
Standard Efficiency Throwaway (Standard)				
Quantity...Size (in.)	12...20 x 25 x 2, 12...20 x 20 x 2	12...20 x 25 x 2, 12...20 x 20 x 2		12...20 x 25 x 2, 12...20 x 20 x 2
30% and 65% Pleated (Optional)				
Quantity...Size (in.)	12...20 x 25 x 2, 12...20 x 20 x 2	12...20 x 25 x 2, 12...20 x 20 x 2		12...20 x 25 x 2, 12...20 x 20 x 2
OUTSIDE AIR SCREENS				
Standard Hood (25%)				
Quantity...Size (in.)	4...25 x 16 x 1, 2...20 x 16 x 1	4...25 x 16 x 1, 2...20 x 16 x 1		4...25 x 16 x 1, 2...20 x 16 x 1
OPTIONAL ECONOMIZER FILTER				
Quantity...Size (in.)	12...16 x 25 x 1, 2...16 x 20 x 1	Aluminum Frame, Permanent 12...16 x 25 x 1, 2...16 x 20 x 1		12...16 x 25 x 1, 2...16 x 20 x 1

LEGEND

- DWDI — Double Width, Double Inlet
- MBtuh — Btuh in Thousands
- SWSI — Single Width, Single Inlet
- TXV — Thermostatic Expansion Valve

Physical data — 50 series units



50P2,P3,P4,P5030,035

BASE UNIT	50P2,P3,P4,P5030		50P2,P3,P4,P5035	
NOMINAL CAPACITY (tons)	30		35	
OPERATING WEIGHT (lb)	Standard Chassis	Extended Chassis	Standard Chassis	Extended Chassis
Base Unit				
Vertical Discharge	4810	5310	4910	5410
Horizontal Discharge and Vertical Discharge with Discharge Plenum	5110	5610	5210	5710
With Economizer				
Vertical Discharge	5110	5610	5210	5710
Horizontal Discharge and Vertical Discharge with Discharge Plenum	5410	5910	5510	6010
COMPRESSORS	Scroll			
Quantity...Type	1...ZP154/1...ZP154		1...ZP182/1...ZP182	
Oil Charge (oz) per Compressor	110		110	
Number of Refrigerant Circuits	2		2	
REFRIGERANT	R-410A			
Operating Charge (lb), Ckt 1/Ckt 2				
Standard Evaporator Coil	15.4/14.8		18.4/17.6	
Standard Evaporator with Humidi-MiZer® System	15.4/24.9		18.4/27.7	
Alternate High-Capacity Evaporator Coil	17.2/16.0		N/A	
Alternate High-Capacity Evaporator with Humidi-MiZer	17.2/26.1		N/A	
CONDENSER COILS	Aluminum Novation® Heat Exchanger with Microchannel Coils			
Quantity	1		1	
Total Face Area (sq ft)	33.3		33.3	
EVAPORATOR COILS	1 32.1 TXV...1			
Quantity				
Total Face Area (sq ft)				
Refrigerant Feed Device...No. per Circuit				
Standard Evaporator Coils				
Rows...Fins/in.	3...15.0		4...15.0	
Fin Type	Double Wavy		Double Wavy	
Tube Type	Cross Hatched		Cross Hatched	
Alternate, High-Capacity Evaporator Coils				
Rows...Fins/in.	4...15.0		N/A	
Fin Type	Double Wavy		N/A	
Tube Type	Cross Hatched		N/A	
OPTIONAL HUMIDI-MIZER® ADAPTIVE DEHUMIDIFICATION SYSTEM	E-Coated Aluminum Novation® Heat Exchanger with Microchannel Coil Technology			
Coil Construction				
Quantity	1		1	
Face Area (sq ft)	26.7	26.7	26.7	26.7
OPTIONAL HYDRONIC HEAT COIL	½-in. OD copper tubes, aluminum plate fins, galvanized steel frame			
Face Area (sq ft)	22.6		22.6	
Rows...Fins Per Inch	2...8		2...8	
Circuit Arrangement	Half		Half	
Connections — (Qty) Dim				
Supply (in.)	(1) 2 ½ NPT		(1) 2 ½ NPT	
Return (in.)	(1) 2 ½ NPT		(1) 2 ½ NPT	
Header Material	Steel		Steel	
Internal Volumes (cu ft)	0.5272		0.5272	
CONDENSER FANS	Propeller Type			
Quantity...Diameter (in.)	2...30		2...30	
Nominal Cfm	18,000		19,500	
Motor Hp...Rpm	1.0...1140		1.0...1140	
SUPPLY FAN	Centrifugal 25 x 25 in.			
Nominal Cfm	12,000		14,000	
Maximum Allowable Cfm	15,000		15,000	
Maximum Allowable Rpm	900		900	
Shaft Diameter at Pulley (in.)	1 11/16		1 11/16	
SUPPLY-FAN MOTOR AND DRIVE	(Any motor available on any unit)			
Motor Hp	7.5	10	15	20
Motor Frame Size	213T	215T	254T	256T
Efficiency at Full Load (%)	91.7	91.7	93.0	93.6
Fan Pulley Pitch Diameter (in.)	13.7	13.7	13.7	13.7
Motor Pulley Pitch Diameter (in.)	3.4	4.3	4.9	5.5
Resulting Fan Speed (rpm)	438	549	626	703
Belts Quantity...Type	2...BX60	2...5VX630	2...5VX630	2...5VX630
Center Distance Range (in.)	17.74-14.30	17.74-14.30	17.63...14.01	17.63...14.01
OPTIONAL POWER EXHAUST	Centrifugal, 18 x 15 in. (Any motor available on any unit)			
Quantity...Motor Hp	2...3.0	2...5.0	2...7.5	2...10
Motor Frame Size	182T	184T	213T	215T
Efficiency at Full Load (%)	88.5	89.5	91.7	91.7
Fan Pulley Pitch Diameter (in.)	11.0	10.4	12	12
Motor Pulley Pitch Diameter Range (in.)	4.1-3.1	4.7-3.7	6.0-4.8	7.0-5.8
Motor Pulley Pitch Diameter Factory Setup (in.)	4.1	4.2	5.4	6.4
Blower Shaft Diameter at Pulley (in.)	17/16	17/16	17/16	17/16
Fan Rpm Range	500-656	621-785	717-882	854-1000
Factory Setup Fan Rpm	656	703	800	927
Maximum Allowable Rpm	1000	1000	1000	1000

LEGEND

TXV — Thermostatic Expansion Valve

Physical data — 50 series units (cont)



50P2,P3,P4,P5030,035 (cont)

BASE UNIT	50P2,P3,P4,P5030	50P2,P3,P4,P5035
NOMINAL CAPACITY (tons)	30	35
FILTERS		
Standard Efficiency Throwaway (Standard) Quantity...Size (in.)	8...20 x 25 x 2, 8...20 x 20 x 2	8...20 x 25 x 2, 8...20 x 20 x 2
Medium Efficiency (30%) Pleated (Optional) Quantity...Size (in.)	8...20 x 25 x 2, 8...20 x 20 x 2	8...20 x 25 x 2, 8...20 x 20 x 2
High Efficiency (90%) Bag Filters with High Velocity Prefilters (Opt) Quantity...Size (in.)	6...20 x 24 x 22, 6...20 x 20 x 22 12...16 x 20 x 2, 3...20 x 24 x 2	6...20 x 24 x 22, 6...20 x 20 x 22 12...16 x 20 x 2, 3...20 x 24 x 2
Cartridge Filters with High Velocity Prefilters (Opt) Quantity...Size (in.)	6...20 x 24 x 12, 6...20 x 20 x 12 12...16 x 20 x 2, 3...20 x 24 x 2	6...20 x 24 x 12, 6...20 x 20 x 12 12...16 x 20 x 2, 3...20 x 24 x 2
OUTSIDE AIR SCREENS		
Standard Hood (25%) Quantity...Size (in.)	None	None
OPTIONAL ECONOMIZER FILTER		
Quantity...Size (in.)	5...20 x 20 x 2, 2...20 x 25 x 1	Aluminum Frame, Permanent 5...20 x 20 x 1, 2...20 x 25 x 1

LEGEND

TXV — Thermostatic Expansion Valve

50P2,P3,P4,P5040,050

BASE UNIT	50P2,P3,P4,P5040				50P2,P3,P4,P5050			
NOMINAL CAPACITY (tons)	40				50			
OPERATING WEIGHT (lb)	Standard Chassis		Extended Chassis		Standard Chassis		Extended Chassis	
Base Unit								
Vertical Discharge	5310		5810		5525		6025	
Horizontal Discharge and Vertical Discharge with Discharge Plenum	5610		6110		5825		6325	
With Economizer								
Vertical Discharge	5610		6110		5825		6325	
Horizontal Discharge and Vertical Discharge with Discharge Plenum	5910		6410		6125		6625	
COMPRESSORS	Scroll							
Quantity...Type	2...ZP103/1...ZP182				2...ZP120/2...ZP137			
Oil Charge (oz) per Compressor	110				110			
Number of Refrigerant Circuits	2				2			
REFRIGERANT	R-410A							
Operating Charge (lb), Ckt 1/Ckt 2								
Standard Evaporator Coil	21.6/26.7				29.4/29.0			
Standard Evaporator with Humidi-MiZer® System	21.6/39.1				29.4/41.4			
Alternate High-Capacity Evaporator Coil	31.1/37.2				35.2/36.5			
Alternate High-Capacity Evaporator with Humidi-MiZer	31.1/49.6				35.2/48.9			
CONDENSER COILS	Aluminum Novation® Heat Exchanger with Microchannel Coils							
Quantity	2				2			
Total Face Area (sq ft)	66.7				66.7			
EVAPORATOR COILS	2 45.5 TXV...2							
Quantity								
Total Face Area (sq ft)								
Refrigerant Feed Device...No. per Circuit								
Standard Evaporator Coils								
Rows...Fins/in.	3...15.0				4...15.0			
Fin Type	Double Wavy				Double Wavy			
Tube Type	Cross Hatched				Cross Hatched			
Alternate, High-Capacity Evaporator Coils								
Rows...Fins/in.	6...16.0				6...16.0			
Fin Type	Double Wavy				Double Wavy			
Tube Type	Cross Hatched				Cross Hatched			
OPTIONAL HUMIDI-MIZER® ADAPTIVE DEHUMIDIFICATION SYSTEM	E-Coated Aluminum Novation® Heat Exchanger with Microchannel Coil Technology							
Coil Construction								
Quantity	1		1		1		1	
Face Area (sq ft)	26.7		26.7		26.7		26.7	
OPTIONAL HYDRONIC HEAT COIL	½-in. OD copper tubes, aluminum plate fins, galvanized steel frame							
Face Area (sq ft)	22.6				22.6			
Rows...Fins Per Inch	2...8				2...8			
Circuit Arrangement	Half				Half			
Connections — (Qty) Dim								
Supply (in.)	(1) 2 ½ NPT				(1) 2 ½ NPT			
Return (in.)	(1) 2 ½ NPT				(1) 2 ½ NPT			
Header Material	Steel				Steel			
Internal Volumes (cu ft)	0.5272				0.5272			
CONDENSER FANS	Propeller Type							
Quantity...Diameter (in.)	3...30				4...30			
Nominal Cfm	30,000				38,000			
Motor Hp...Rpm	1.0...1140				1.0...1140			
SUPPLY FAN	Centrifugal 25 x 25 in.							
Nominal Cfm	16,000				20,000			
Maximum Allowable Cfm	20,000				20,000			
Maximum Allowable Rpm	900				900			
Shaft Diameter at Pulley (in.)	1 11/16				1 11/16			
SUPPLY-FAN MOTOR AND DRIVE	(Any motor available on any unit)							
Motor Hp	7.5	10	15	20	25	30*		
Motor Frame Size	213T	215T	254T	256T	284T	286T		
Efficiency at Full Load (%)	91.7	91.7	93.0	93.6	93.6	93.6		
Fan Pulley Pitch Diameter (in.)	13.7	13.7	13.7	13.7	13.7	12.5		
Motor Pulley Pitch Diameter (in.)	3.4	4.3	4.9	5.5	6.5	6.5		
Resulting Fan Speed (rpm)	438	549	626	703	830	910		
Belts Quantity...Type	2...BX60	2...5VX630	2...5VX630	2...5VX630	2...5VX650	3...5VX630		
Center Distance Range (in.)	17.74-14.30	17.74-14.30	17.63...14.01	17.63...14.01	16.63...12.87	16.63...12.87		
OPTIONAL POWER EXHAUST	Centrifugal, 18 x 15 in. (Any motor available on any unit)							
Quantity...Motor Hp	2...3.0		2...5.0		2...7.5		2...10	
Motor Frame Size	182T		184T		213T		215T	
Efficiency at Full Load (%)	88.5		89.5		91.7		91.7	
Fan Pulley Pitch Diameter (in.)	11.0		10.4		12		12	
Motor Pulley Pitch Diameter Range (in.)	4.1-3.1		4.7-3.7		6.0-4.8		7.0-5.8	
Motor Pulley Pitch Diameter Factory Setup (in.)	4.1		4.2		5.4		6.4	
Blower Shaft Diameter at Pulley (in.)	1 7/16		1 7/16		1 7/16		1 7/16	
Fan Rpm Range	500-656		621-785		717-882		854-1000	
Factory Setup Fan Rpm	656		703		800		927	
Maximum Allowable Rpm	1000		1000		1000		1000	

LEGEND

TXV — Thermostatic Expansion Valve

* 460-3-60 only.

Physical data — 50 series units (cont)



50P2,P3,P4,P5040,050 (cont)

BASE UNIT	50P2,P3,P4,P5040	50P2,P3,P4,P5050
NOMINAL CAPACITY (tons)	40	50
FILTERS		
Standard Efficiency Throwaway (Standard) Quantity...Size (in.)	8...20 x 25 x 2, 8...20 x 20 x 2	8...20 x 25 x 2, 8...20 x 20 x 2
Medium Efficiency (30%) Pleated (Optional) Quantity...Size (in.)	8...20 x 25 x 2, 8...20 x 20 x 2	8...20 x 25 x 2, 8...20 x 20 x 2
High Efficiency (90%) Bag Filters with High Velocity Prefilters (Optional) Quantity...Size (in.)	6...20 x 24 x 22, 6...20 x 20 x 22	6...20 x 24 x 22, 6...20 x 20 x 22
Bag Filter Prefilter	12...16 x 20 x 2, 3...20 x 24 x 2	12...16 x 20 x 2, 3...20 x 24 x 2
Cartridge Filters with High Velocity Prefilters (Opt) Quantity...Size (in.)	6...20 x 24 x 12, 6...20 x 20 x 12	6...20 x 24 x 12, 6...20 x 20 x 12
Cartridge Filter Prefilter	12...16 x 20 x 2, 3...20 x 24 x 2	12...16 x 20 x 2, 3...20 x 24 x 2
OUTSIDE AIR SCREENS		
Standard Hood (25%) Quantity...Size (in.)	None	None
OPTIONAL ECONOMIZER FILTER		
Quantity...Size (in.)	5...20 x 20 x 2, 2...20 x 25 x 1	Aluminum Frame, Permanent 5...20 x 20 x 1, 2...20 x 25 x 1

LEGEND

TXV — Thermostatic Expansion Valve

* 460-3-60 only.

50P2,P3,P4,P5055-070

BASE UNIT	50P2,P3,P4,P5055		50P2,P3,P4,P5060		50P2,P3,P4,P5070	
NOMINAL CAPACITY (tons)	55		60		70	
OPERATING WEIGHT (lb)	Standard Chassis	Extended Chassis	Standard Chassis	Extended Chassis	Standard Chassis	Extended Chassis
Base Unit						
Vertical Discharge	6820	7370	6875	7425	7215	7765
Horizontal Discharge and Vertical Discharge with Discharge Plenum	7370	7920	7425	7975	7765	8315
With Economizer						
Vertical Discharge	7350	7900	7405	7955	7745	8295
Horizontal Discharge and Vertical Discharge with Discharge Plenum	7900	8450	7955	8505	8295	8845
COMPRESSORS	Scroll					
Quantity...Type	2...ZP137/2...ZP137		2...ZP154/2...ZP154		1...ZP154, 1...ZP182/ 1...ZP154, 1...ZP182	
Oil Charge (oz) per Compressor	110		110		110	
Number of Refrigerant Circuits	2		2		2	
REFRIGERANT	R-410A					
Operating Charge (lb), Ckt 1/Ckt 2						
Standard Evaporator Coil	37.6/37.9		37.6/37.9		39.5/42.0	
Standard Evaporator with Humidi-MiZer® System	37.6/50.3		37.6/50.3		39.5/54.4	
Alternate High-Capacity Evaporator Coil	43.5/42.8		44.6/43.5		49.0/50.0	
Alternate High-Capacity Evaporator with Humidi-MiZer	43.5/55.2		44.6/55.9		49.0/62.4	
CONDENSER COILS	Aluminum Novation® Heat Exchanger with Microchannel Coils					
Quantity	2		2		4	
Total Face Area (sq ft)	66.7		66.7		106.7	
EVAPORATOR COILS						
Quantity	2					
Total Face Area (sq ft)	61.5					
Refrigerant Feed Device...No. per Circuit	TXV...2					
Standard Evaporator Coils						
Rows...Fins/in.	4...15		4...15		4...15	
Fin Type	Double Wavy		Double Wavy		Double Wavy	
Tube Type	Cross Hatched		Cross Hatched		Cross Hatched	
Alternate, High-Capacity Evaporator Coils						
Rows...Fins/in.	6...16		6...16		6...16	
Fin Type	Double Wavy		Double Wavy		Double Wavy	
Tube Type	Cross Hatched		Cross Hatched		Cross Hatched	
OPTIONAL HUMIDI-MIZER® ADAPTIVE DEHUMIDIFICATION SYSTEM						
Coil Construction	E-Coated Aluminum Novation® Heat Exchanger with Microchannel Coil Technology					
Quantity	1		1		1	
Face Area (sq ft)	26.7		26.7		26.7	
OPTIONAL HYDRONIC HEAT COIL	½-in. OD copper tubes, aluminum plate fins, galvanized steel frame					
Face Area (sq ft)	(2) sections: total 27.1		(2) sections: total 27.1		(2) sections: total 27.1	
Rows...Fins Per Inch	2...11		2...11		2...11	
Circuit Arrangement	Half		Half		Half	
Connections — (Qty) Dim						
Supply (in.)	(2) 1 ½ NPT		(2) 1 ½ NPT		(2) 1 ½ NPT	
Return (in.)	(2) 1 ½ NPT		(2) 1 ½ NPT		(2) 1 ½ NPT	
Header Material	Steel		Steel		Steel	
Internal Volumes (cu ft)	0.6327		0.6327		0.6327	
CONDENSER FANS	Propeller Type					
Quantity...Diameter (in.)	4...30		4...30		4...30	
Nominal Cfm	36,000		36,600		39,000	
Motor Hp...Rpm	1.0...1140		1.0...1140		1.0...1140	
SUPPLY FAN	Centrifugal 30 x 27.5 in.					
Nominal Cfm	22,000		24,000		28,000	
Maximum Allowable Cfm	25,000		30,000		30,000	
Maximum Allowable Rpm	800		800		800	
Shaft Diameter at Pulley (in.)	1 11/16		1 11/16		1 11/16	
SUPPLY-FAN MOTOR AND DRIVE	(Any motor available on any unit)					
Motor Hp	15		20		30	
Motor Frame Size	254T		256T		284T	
Efficiency at Full Load (%)	93.0		93.6		93.6	
Fan Pulley Pitch Diameter (in.)	13.7		13.7		13.7	
Motor Pulley Pitch Diameter (in.)	4.5		5.1		5.5	
Resulting Fan Speed (rpm)	575		651		703	
Belts Quantity...Type	2...5VX1230		2...5VX1230		2...5VX1230	
Center Distance Range (in.)	48.25-44.00		48.25-44.00		48.50-44.25	
OPTIONAL POWER EXHAUST	Centrifugal, 18 x 15 in. (Any motor available on any unit)					
Quantity...Motor Hp	2...5		2...7.5		2...10	
Motor Frame Size	184T		213T		215T	
Efficiency at Full Load (%)	89.5		91.7		91.7	
Resulting Fan Rpm	740		820		920	
Maximum Allowable Rpm	1000		1000		1000	

LEGEND

TXV — Thermostatic Expansion Valve

* 460-3-60 and 575-3-60 only.

Physical data — 50 series units (cont)



50P2,P3,P4,P5055-070 (cont)

BASE UNIT	50P2,P3,P4,P5055	50P2,P3,P4,P5060	50P2,P3,P4,P5070
NOMINAL CAPACITY (tons)	55	60	70
FILTERS			
Standard Efficiency Throwaway (Standard) Quantity...Size (in.)	12...20 x 25 x 2, 12...20 x 20 x 2	12...20 x 25 x 2, 12...20 x 20 x 2	12...20 x 25 x 2, 12...20 x 20 x 2
Medium Efficiency (30%) Pleated (Optional) Quantity...Size (in.)	12...20 x 25 x 2, 12...20 x 20 x 2	12...20 x 25 x 2, 12...20 x 20 x 2	12...20 x 25 x 2, 12...20 x 20 x 2
High Efficiency (90%) Bag Filters with High Velocity Prefilters (Optional) Quantity...Size (in.)	6...24 x 24 x 22, 6...24 x 20 x 22	6...24 x 24 x 22, 6...24 x 20 x 22	6...24 x 24 x 22, 6...24 x 20 x 22
Bag Filter Prefilter	6...24 x 24 x 2, 6...20 x 24 x 2	6...24 x 24 x 2, 6...20 x 24 x 2	6...24 x 24 x 2, 6...20 x 24 x 2
Cartridge Filters with High Velocity Prefilters (optional) Quantity...Size (in.)	6...24 x 24 x 12, 6...24 x 20 x 12	6...24 x 24 x 12, 6...24 x 20 x 12	6...24 x 24 x 12, 6...24 x 20 x 12
Cartridge Filter Prefilter	6...24 x 24 x 2, 6...20 x 24 x 2	6...24 x 24 x 2, 6...20 x 24 x 2	6...24 x 24 x 2, 6...20 x 24 x 2
OUTSIDE AIR SCREENS			
Standard Hood (25%) Quantity...Size (in.)	4...25 x 16 x 1 2...20 x 16 x 1	4...25 x 16 x 1 2...20 x 16 x 1	4...25 x 16 x 1 2...20 x 16 x 1
OPTIONAL ECONOMIZER FILTER		Aluminum Frame, Permanent	
Quantity...Size (in.)	12...16 x 25 x 1 2...16 x 20 x 1	12...16 x 25 x 1 2...16 x 20 x 1	12...16 x 25 x 1 2...16 x 20 x 1

LEGEND

TXV — Thermostatic Expansion Valve

* 460-3-60 and 575-3-60 only.

50P2,P3,P4,P5075-100

BASE UNIT	50P2,P3,P4,P5075		50P2,P3,P4,P5090		50P2,P3,P4,P5100	
NOMINAL CAPACITY (tons)	75		90		100	
OPERATING WEIGHT (lb)	Standard Chassis	Extended Chassis	Standard Chassis	Extended Chassis	Standard Chassis	Extended Chassis
Base Unit						
Vertical Discharge	8665	9215	9265	9815	9285	9835
Horizontal Discharge and Vertical Discharge with Discharge Plenum	—	—	—	—	—	—
With Economizer						
Vertical Discharge	9195	9745	9795	10,345	9815	10,365
Horizontal Discharge and Vertical Discharge with Discharge Plenum	—	—	—	—	—	—
COMPRESSORS	Scroll					
Quantity...Type	2...ZP182/2...ZP182		3...ZP154,3...ZP154		3...ZP154,3...ZP182	
Oil Charge (oz) per Compressor	110		110		110	
Number of Refrigerant Circuits	2		2		2	
REFRIGERANT	R-410A					
Operating Charge (lb), Ckt 1/Ckt 2						
Standard Evaporator Coil	39.5/42.0		50.4/51.3		50.8/52.8	
Standard Evaporator with Humidi-MiZer® System	39.5/54.4		50.4/69.1		50.8/70.6	
Alternate High-Capacity Evaporator Coil	49.0/50.0		61.5/62.9		59.3/62.8	
Alternate High-Capacity Evaporator with Humidi-MiZer	49.0/62.4		61.5/80.7		59.3/80.6	
CONDENSER COILS	Aluminum Novation® Heat Exchanger with Microchannel Coils					
Quantity	4		6		6	
Total Face Area (sq ft)	106.7		160.0		160.0	
EVAPORATOR COILS	2					
Quantity	61.5					
Total Face Area (sq ft)	TXV...2					
Refrigerant Feed Device...No. per Circuit						
Standard Evaporator Coils						
Rows...Fins/in.	4...15		4...15		4...15	
Fin Type	Double Wavy		Double Wavy		Double Wavy	
Tube Type	Cross Hatched		Cross Hatched		Cross Hatched	
Alternate, High-Capacity Evaporator Coils						
Rows...Fins/in.	6...16		6...16		6...16	
Fin Type	Double Wavy		Double Wavy		Double Wavy	
Tube Type	Cross Hatched		Cross Hatched		Cross Hatched	
OPTIONAL HUMIDI-MIZER® ADAPTIVE DEHUMIDIFICATION SYSTEM	E-Coated Aluminum Novation® Heat Exchanger with Microchannel Coil Technology					
Coil Construction						
Quantity	1		1		1	
Face Area (sq ft)	26.7		33.3		33.3	
OPTIONAL HYDRONIC HEAT COIL	½-in. OD copper tubes, aluminum plate fins, galvanized steel frame					
Face Area (sq ft)	(2) sections: total 27.1		(2) sections: total 27.1		(2) sections: total 27.1	
Rows...Fins Per Inch	2...11		2...11		2...11	
Circuit Arrangement	Half		Half		Half	
Connections — (Qty) Dim						
Supply (in.)	(2) 1 ½ NPT		(2) 1 ½ NPT		(2) 1 ½ NPT	
Return (in.)	(2) 1 ½ NPT		(2) 1 ½ NPT		(2) 1 ½ NPT	
Header Material	Steel		Steel		Steel	
Internal Volumes (cu ft)	0.6327		0.6327		0.6327	
CONDENSER FAN	Propeller Type					
Quantity...Diameter (in.)	4...30		6...30		6...30	
Nominal Cfm	39,000		58,000		58,000	
Motor Hp (ea)...rpm	1.0...1140		1.0...1140		1.0...1140	
STANDARD SUPPLY FAN	Forward Curved Centrifugal 36 x 30 in.					
Nominal Cfm	30,000		36,000		40,000	
Maximum Allowable Cfm	30,000		36,000		40,000	
Maximum Allowable Rpm	680		680		680	
Shaft Diameter at Pulley (in.)	1 11/16		1 11/16		1 11/16	
STANDARD SUPPLY-FAN MOTOR AND DRIVE	(Any motor available on any unit)					
Motor Hp	30	40	50	60		
Motor Frame Size	S268T	S324T	S326T	S364T		
Efficiency at Full Load (%)	93.6	94.5	94.5	95.4		
Fan Pulley Pitch Diameter (in.)	18.5	18.5	18.5	18.5		
Motor Pulley Pitch Diameter (in.)	5.3	5.7	6.5	7.1		
Resulting Fan Rpm	501	539	615	672		
Belts Quantity...Type	3...5VX1320		4...5VX1320		4...5VX1320	
Center Distance Range (in.)	47.88-45.01		47.64-44.76		47.42-44.52	
ALTERNATE, AIRFOIL FAN	DWDI Airfoil, 33 in.					
Nominal Airflow (cfm)	30,000		36,000		40,000	
Maximum Allowable Airflow (cfm)	30,000		36,000		40,000	
Maximum Allowable Wheel Speed (rpm)	1846		1846		1846	
Shaft Diameter at Pulley (in.)	2 11/16		2 11/16		2 11/16	
ALTERNATE SUPPLY-FAN MOTOR AND DRIVE	(Any motor available on any unit)					
Motor Hp	30	40	50	60	75	
Motor Frame Size	S268T	S324T	S326T	S364T	365T	
Efficiency at Full Load (%)	93.6	94.5	94.5	95.4	95.4	
Fan Pulley Pitch Diameter (in.)	9.7	10.2	8.9	8.9	10.8	
Motor Pulley Pitch Diameter (in.)	7.5	8.7	8.1	8.7	11.1	
Resulting Fan Rpm	1353	1493	1593	1711	1799	
Belts Quantity...Type	2...5VX1150		3...5VX1150		3...5VX1230	
Center Distance Range (in.)	42.96...45.82		42.96...45.57		42.45...45.35	

LEGEND

- DWDI — Double Width, Double Inlet
- TXV — Thermostatic Expansion Valve
- SWSI — Single Width, Single Inlet

Physical data — 50 series units (cont)



50P2,P3,P4,P5075-100 (cont)

BASE UNIT	50P2,P3,P4,P5075	50P2,P3,P4,P5090	50P2,P3,P4,P5100		
NOMINAL CAPACITY (tons)	75	90	100		
OPTIONAL RETURN/EXHAUST FAN	SWSI Airfoil Plenum Fan, 47.13 in. (Any motor available on any unit.)				
Quantity...Motor Hp	1...20	1...25	1...30	1...40	
Motor Frame Size	256T	284T	286T	324T	
Efficiency at Full Load (%)	93.6	93.6	93.6	93.8	
Fan Pulley Pitch Diameter (in.)	8.5	9.8	8.5	8.5	
Motor Pulley Pitch Diameter (in.)	5.3	6.7	6.1	6.7	
Shaft Diameter at Pulley (in.)	2 ¹⁵ / ₁₆	2 ¹⁵ / ₁₆	2 ¹⁵ / ₁₆	2 ¹⁵ / ₁₆	
Resulting Fan Rpm	1104	1209	1271	1396	
Maximum Allowable Rpm	1447	1447	1447	1447	
OPTIONAL POWER EXHAUST	Centrifugal, 18 x 15 in. (Any motor available on any unit.)				
Quantity...Motor Hp	2...5	2...7.5	2...10		
Motor Frame Size	184T	213T	215T		
Efficiency at Full Load (%)	89.5	91.7	91.7		
Fan Pulley Pitch Diameter (in.)	10.6	10.6	10.6		
Motor Pulley Pitch Diameter (in.)	4.5	5.0	5.6		
Shaft Diameter at Pulley (in.)	1 ⁷ / ₁₆	1 ⁷ / ₁₆	1 ⁷ / ₁₆		
Resulting Fan Rpm	740	820	920		
Maximum Allowable Rpm	1000	1000	1000		
OPTIONAL HIGH-CAPACITY POWER EXHAUST	Centrifugal, 22 x 20 in., 1 ¹¹ / ₁₆ in. shaft diameter (Any motor available on any unit)				
Total Hp	20	30	40	50	60
Quantity...Motor Hp	2...10	2...15	2...20	2...25	2...30
Motor Frame Size	S215T	D254T	S256T	S284T	S286T
Efficiency at Full Load (%)	91.7	93.0	93.6	93.6	93.6
Fan Sheave Pitch Diameter (in.)	12.4	12.4	11.1	11.1	11.1
Motor Sheave Pitch Diameter (in.)	4.8	5.8	5.9	6.5	6.9
Resulting Fan Rpm	714	841	928	1020	1094
Maximum Allowable Rpm	1175	1175	1175	1175	1175
Belts Quantity...Type	2...BX93	2...BX93	2...SVX950	2...SVX950	2...SVX950
FILTERS					
Standard Efficiency Throwaway (Standard)	12...20 x 25 x 2	12...20 x 25 x 2	12...20 x 25 x 2	12...20 x 25 x 2	
Quantity...Size (in.)	12...20 x 20 x 2	12...20 x 20 x 2	12...20 x 20 x 2	12...20 x 20 x 2	
30% and 65% Pleated (Optional)	12...20 x 25 x 2	12...20 x 25 x 2	12...20 x 25 x 2	12...20 x 25 x 2	
Quantity...Size (in.)	12...20 x 20 x 2	12...20 x 20 x 2	12...20 x 20 x 2	12...20 x 20 x 2	
OUTSIDE AIR SCREENS					
Standard Hood (25%) Quantity...Size (in.)	4...25 x 16 x 1	4...25 x 16 x 1	4...25 x 16 x 1	4...25 x 16 x 1	
	2...20 x 16 x 1	2...20 x 16 x 1	2...20 x 16 x 1	2...20 x 16 x 1	
OPTIONAL ECONOMIZER FILTER		Aluminum Frame, Permanent			
Quantity...Size (in.)	12...16 x 25 x 1	12...16 x 25 x 1	12...16 x 25 x 1	12...16 x 25 x 1	
	2...16 x 20 x 1	2...16 x 20 x 1	2...16 x 20 x 1	2...16 x 20 x 1	

LEGEND

- DWDI — Double Width, Double Inlet
- TXV — Thermostatic Expansion Valve
- SWSI — Single Width, Single Inlet

Physical data



SUPPLY FAN DRIVE DATA

HP	SHAFT DIA (in.)	SPEED (rpm)	MOTOR SHEAVE	MOTOR PITCH DIA. (in.)	WHEEL SHEAVE	WHEEL PITCH DIA. (in.)	QUANTITY ...BELT
Sizes 030-050							
7.5	1 ³ / ₈	438	2BK36	3.4	2B5V136	13.7	2...BX60
10	1 ³ / ₈	549	2B5V42	4.3	2B5V136	13.7	2...5VX630
15	1 ⁵ / ₈	626	2B5V48	4.9	2B5V136	13.7	2...5VX630
20	1 ⁵ / ₈	703	2B5V54	5.5	2B5V136	13.7	2...5VX630
25	1 ⁷ / ₈	830	2B5V64	6.5	2B5V136	13.7	2...5VX650
30*	1 ⁷ / ₈	910	3B5V64	6.5	3B5V124	12.5	3...5VX630
Sizes 055-070							
15	1 ⁵ / ₈	575	2B5V44	4.5	2B5V136	13.7	2...5VX1230† 2...5VX1120**
20	1 ⁵ / ₈	651	2B5V50	5.1	2B5V136	13.7	2...5VX1230† 2...5VX1150**
25	1 ⁷ / ₈	703	2B5V54	5.5	2B5V136	13.7	2...5VX1230† 2...5VX1150**
30	1 ⁷ / ₈	711	2B5V62	5.9	2B5V154	15.5	2...5VX1230† 2...5VX1180**
40	2 ¹ / ₈	740	3B5V66	6.7	3B5V160	16.1	3...5VX1250† 3...5VX1180**
Sizes 075-100 (Forward Curved Fan)							
30	1 ⁷ / ₈	501	3B5V52	5.33	B5V184	18.5	3...5VX1320
40	2 ¹ / ₈	539	4B5V56	5.74	B5V184	18.5	4...5VX1320
50	2 ¹ / ₈	615	4B5V64	6.54	B5V184	18.5	4...5VX1320
60	2 ³ / ₈	672	4B5V70	7.14	B5V184	18.5	4...5VX1320
Sizes 075-100 (Airfoil Fan)							
30	1 ⁷ / ₈	1353	2B5V74	7.5	2Q5V97	9.7	2...5VX1150
40	2 ¹ / ₈	1493	2B5V86	8.7	2Q5V103	10.2	2...5VX1180
50	2 ¹ / ₈	1593	3B5V80	8.1	3R5V90	8.9	3...5VX1150
60	2 ³ / ₈	1711	3B5V86	8.7	3R5V90	8.9	3...5VX1150
75	2 ³ / ₈	1799	3B5V110	11.1	3R5V109	10.8	3...5VX1230

*Sizes 040,050 only.

†Horizontal discharge units (50 Series only).

**Vertical discharge and extended plenum units.

NOTE: Part numbers are Browning Manufacturing Corp. reference.

POWER EXHAUST FAN DRIVE DATA (Two Drive Sets Per Unit)

TOTAL HP	MOTOR QTY...HP	MOTOR SHAFT DIAMETER (in.)	FAN SPEED RPM	MOTOR SHEAVE		BLOWER SHEAVE		48/50P2,P3 UNITS		48/50P4,P5 UNITS	
				Part Number	Pitch Diameter (in.)	Part Number	Pitch Diameter (in.)	BELTS QTY...P/N	CENTER DISTANCE RANGE (in.)	BELTS QTY...P/N	CENTER DISTANCE RANGE (in.)
Sizes 030-050											
6	2...3	1 ¹ / ₈	656/500	1VP44L	4.1-3.1	BK115	11	1...BX71	23.62-26.50	1...BX46	11.40-13.26
10	2...5	1 ¹ / ₈	785/621	1VP50L	4.7-3.7	BK110	10.4	1...BX71	23.62-26.50	1...BX46	11.16-13.05
15	2...7.5	1 ³ / ₈	882/717	1VP65	6.0-4.8	BK130	12	1...BX77	23.62-26.50	1...BX53	11.40-13.26
20	2...10	1 ³ / ₈	1000/854	1VP75	7.0-5.8	BK130	12	1...BX79	23.62-26.50	1...BX53	11.04-12.95
Sizes 055-100											
10	2...5	1 ¹ / ₈	740	2P3V45	4.5	2Q3V106	10.6	2...3VX71	22.71-26.38	2...3VX50	10.91-13.30
15	2...7.5	1 ³ / ₈	820	2P3V50	5.0	2Q3V106	10.6	2...3VX71	22.71-26.38	2...3VX50	10.78-13.20
20	2...10	1 ³ / ₈	920	2P3V56	5.6	2Q3V106	10.6	2...3VX75	22.71-26.38	2...3VX50	10.78-13.20

NOTE: Part numbers are Browning Manufacturing Corp. reference.

Physical data (cont)



HIGH-CAPACITY POWER EXHAUST FAN DRIVE DATA (Two Drive Sets Per Unit) (Size 075-100 Units Only)

TOTAL HP	MOTOR QTY...HP	MOTOR SHAFT DIAMETER (in.)	FAN SPEED RPM	MOTOR SHEAVE		BLOWER SHEAVE		BELTS QTY...P/N	CENTER DISTANCE RANGE (in.)
				Part Number	Pitch Diameter (in.)	Part Number	Pitch Diameter (in.)		
20	2...10	1.375	714	2B5V48	4.8	2B5V124	12.4	2...BX93	32.8 to 36.7
30	2...15	1.625	841	2B5V58	5.8	2B5V124	12.4	2...BX93	32.6 to 36.5
40	2...20	1.625	928	2B5V58	5.9	2B5V110	11.1	2...5VX950	32.6 to 36.5
50	2...25	1.875	1020	2B5V64	6.5	2B5V110	11.1	2...5VX950	32.5 to 36.3
60	2...30	1.875	1094	2B5V68	6.9	2B5V110	11.1	2...5VX950	32.5 to 36.3

OPTIONAL RETURN/EXHAUST FAN DRIVE DATA (One Drive Set Per Unit) (Size 075-100 Units Only)

TOTAL HP	MOTOR QTY...HP	MOTOR SHAFT DIAMETER (in.)	FAN SPEED RPM	MOTOR SHEAVE		BLOWER SHEAVE		BELTS QTY...P/N	CENTER DISTANCE RANGE (in.)
				Part Number	Pitch Diameter (in.)	Part Number	Pitch Diameter (in.)		
20	1...20	1.625	1104	3B5V52	5.3	3R5V85	8.5	3...5VX1000	38.1 to 41.0
25	1...25	1.875	1209	3B5V66	6.7	3R5V97	9.8	3...5VX1060	38.9 to 41.8
30	1...30	1.875	1271	3B5V60	6.1	3R5V85	8.5	3...5VX1030	38.9 to 41.8
40	1...40	2.125	1396	3B5V66	6.7	3R5V85	8.5	3...5VX1060	39.9 to 42.8

WEIGHT DISTRIBUTION AND CENTER OF GRAVITY — 48 SERIES UNITS

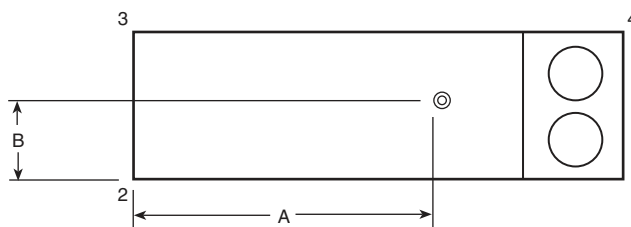

48P2,P3,P4,P5 UNITS	SIZE	CORNER WEIGHTS (lb)				TOTAL (lb)	A		B	
		1	2	3	4		in.		in.	
Vertical Supply/Return	030	2002	1009	1008	2000	6,019	170 5/8	45 7/8	45 7/8	45 7/8
Horizontal Supply/Return	035	2056	1031	1029	2053	6,169	170 7/8	45 7/8	45 7/8	45 7/8
Low Heat	040	1983	1374	1372	1981	6,710	198 1/4	45 7/8	45 7/8	45 7/8
No Extended Chassis	050	2079	1386	1384	2076	6,925	201 1/4	45 7/8	45 7/8	45 7/8
	055	2408	2205	2202	2404	9,220	228 7/8	45 7/8	45 7/8	45 7/8
	060	2417	2223	2220	2414	9,275	228 1/2	45 7/8	45 7/8	45 7/8
	070	2950	2450	1913	2303	9,615	244 5/8	40 1/4	40 1/4	40 1/4
	075	3385	2604	2033	2643	10,665	253 1/8	40 1/4	40 1/4	40 1/4
	090	3255	2911	2407	2691	11,265	261	41 1/2	41 1/2	41 1/2
	100	3248	2929	2422	2686	11,285	260	41 1/2	41 1/2	41 1/2
Vertical Supply/Return	030	2034	1042	1041	2032	6,149	169 3/4	45 7/8	45 7/8	45 7/8
Horizontal Supply/Return	035	2088	1064	1062	2085	6,299	170	45 7/8	45 7/8	45 7/8
Low Heat	040	2013	1410	1408	2010	6,840	197 3/8	45 7/8	45 7/8	45 7/8
No Extended Chassis	050	2108	1422	1420	2105	7,055	200 3/8	45 7/8	45 7/8	45 7/8
	055	2443	2236	2233	2439	9,350	229	45 7/8	45 7/8	45 7/8
	060	2452	2254	2250	2449	9,405	228 1/2	45 7/8	45 7/8	45 7/8
	070	2991	2481	1937	2335	9,745	244 3/4	40 1/4	40 1/4	40 1/4
	075	3444	2618	2044	2689	10,795	254 3/8	40 1/4	40 1/4	40 1/4
	090	3307	2931	2424	2734	11,395	262 1/8	41 1/2	41 1/2	41 1/2
	100	3303	2946	2436	2731	11,415	261 1/4	41 1/2	41 1/2	41 1/2
Vertical Supply/Return	030	2166	1096	1094	2163	6,519	187 1/8	45 7/8	45 7/8	45 7/8
Horizontal Supply/Return	035	2223	1114	1112	2220	6,669	187 3/4	45 7/8	45 7/8	45 7/8
Low Heat	040	2148	1460	1458	2145	7,210	214 3/4	45 7/8	45 7/8	45 7/8
with Extended Chassis	050	2244	1471	1469	2241	7,425	217 7/8	45 7/8	45 7/8	45 7/8
	055	2558	2331	2328	2554	9,770	242 5/8	45 7/8	45 7/8	45 7/8
	060	2567	2349	2346	2563	9,825	242 1/8	45 7/8	45 7/8	45 7/8
	070	3117	2541	2023	2434	10,165	258 7/8	40 1/4	40 1/4	40 1/4
	075	3551	2747	2145	2773	11,215	266 3/4	40 1/4	40 1/4	40 1/4
	090	3419	3048	2521	2827	11,815	274 5/8	41 1/2	41 1/2	41 1/2
	100	3409	3070	2538	2819	11,835	273 3/8	41 1/2	41 1/2	41 1/2
Vertical Supply/Return	030	2197	1130	1129	2194	6,649	186 1/8	45 7/8	45 7/8	45 7/8
Horizontal Supply/Return	035	2253	1148	1147	2250	6,799	186 5/8	45 7/8	45 7/8	45 7/8
Low Heat	040	2177	1496	1494	2174	7,340	213 3/4	45 7/8	45 7/8	45 7/8
with Extended Chassis	050	2272	1508	1506	2269	7,555	216 7/8	45 7/8	45 7/8	45 7/8
	055	2592	2361	2358	2589	9,900	242 3/4	45 7/8	45 7/8	45 7/8
	060	2602	2379	2376	2598	9,955	242 1/4	45 7/8	45 7/8	45 7/8
	070	3158	2623	2048	2466	10,295	258 1/2	40 1/4	40 1/4	40 1/4
	075	3610	2761	2156	2818	11,345	268	40 1/4	40 1/4	40 1/4
	090	3471	3068	2537	2870	11,945	275 3/4	41 1/2	41 1/2	41 1/2
	100	3463	3086	2552	2864	11,965	274 3/4	41 1/2	41 1/2	41 1/2

48P2,P3,P4,P5 UNITS WITH OPTIONAL HIGH-CAPACITY POWER EXHAUST	SIZE	CORNER WEIGHTS (lb)				TOTAL (lb)	A		B	
		1	2	3	4		in.		in.	
Vertical Supply/Return	075	4171	3410	2662	3256	13,499	290	40 1/4	40 1/4	40 1/4
Horizontal Supply/Return	090	4004	3712	3070	3311	14,097	297 5/8	41 1/2	41 1/2	41 1/2
Low Heat	100	4002	3726	3081	3309	14,119	297 1/8	41 1/2	41 1/2	41 1/2
Vertical Supply/Return	075	4230	3424	2673	3302	13,629	291 3/8	40 1/4	40 1/4	40 1/4
Horizontal Supply/Return	090	4058	3730	3084	3356	14,227	299	41 1/2	41 1/2	41 1/2
High Heat	100	4054	3745	3097	3352	14,249	298 1/4	41 1/2	41 1/2	41 1/2
Vertical Supply/Return	075	6905	984	768	5391	14,049	483 1/2	40 1/4	40 1/4	40 1/4
Horizontal Supply/Return	090	6484	1534	1268	5362	14,647	484 3/8	41 1/2	41 1/2	41 1/2
Low Heat with Extended Chassis	100	6620	1409	1165	5474	14,669	493 3/4	41 1/2	41 1/2	41 1/2
Vertical Supply/Return	075	6969	993	776	5441	14,179	483 1/2	40 1/4	40 1/4	40 1/4
Horizontal Supply/Return	090	6541	1547	1280	5409	14,777	484 1/4	41 1/2	41 1/2	41 1/2
High Heat with Extended Chassis	100	6679	1422	1176	5523	14,799	493 3/4	41 1/2	41 1/2	41 1/2

NOTE: The weight distribution and center of gravity information include the impact of an economizer, the largest indoor fan motor, and a VFD (variable frequency drive). On units with a return fan or high-capacity power exhaust, the largest motors and VFD are also included. These weights do not include the impact of other factory-installed options such as barometric relief, power exhaust, high-capacity indoor coil, hot water coil, or indoor fan.

Physical data (cont)



WEIGHT DISTRIBUTION AND CENTER OF GRAVITY — 48 SERIES UNITS (cont)

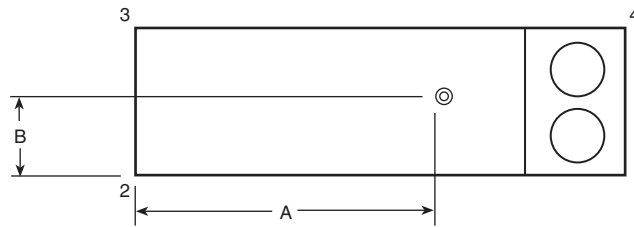

48P2,P3,P4,P5 UNITS WITH OPTIONAL RETURN/EXHAUST FAN	SIZE	CORNER WEIGHTS (lb)				TOTAL (lb)	A in.	B in.
		1	2	3	4			
Vertical Supply/Return	075	3470	3449	2693	2709	12,321	224 ⁵ / ₈	40 ¹ / ₄
Horizontal Supply/Return	090	3327	3745	3097	2751	12,921	232 ⁵ / ₈	41 ¹ / ₂
Low Heat	100	3302	3782	3127	2730	12,941	230 ³ / ₈	41 ¹ / ₂
Vertical Supply/Return	075	3543	3449	2693	2766	12,451	226 ⁷ / ₈	40 ¹ / ₄
Horizontal Supply/Return	090	3377	3767	3115	2793	13,051	233 ³ / ₄	41 ¹ / ₂
High Heat	100	3370	3785	3130	2787	13,071	232 ⁷ / ₈	41 ¹ / ₂
Vertical Supply/Return	075	3609	3618	2825	2818	12,871	236 ¹ / ₄	40 ¹ / ₄
Horizontal Supply/Return	090	3467	3906	3230	2867	13,471	244 ¹ / ₄	41 ¹ / ₂
Low Heat with Extended Chassis	100	3437	3948	3264	2842	13,491	241 ³ / ₄	41 ¹ / ₂
Vertical Supply/Return	075	3681	3620	2826	2874	13,001	238 ¹ / ₂	40 ¹ / ₄
Horizontal Supply/Return	090	3517	3928	3248	2908	13,601	245 ³ / ₈	41 ¹ / ₂
High Heat with Extended Chassis	100	3505	3951	3267	2898	13,621	244 ¹ / ₄	41 ¹ / ₂

NOTE: The weight distribution and center of gravity information include the impact of an economizer, the largest indoor fan motor, and a VFD (variable frequency drive). On units with a return fan or high-capacity power exhaust, the largest motors and VFD are also included. These weights do not include the impact of other factory-installed options such as barometric relief, power exhaust, high-capacity indoor coil, hot water coil, or indoor fan.

WEIGHT DISTRIBUTION AND CENTER OF GRAVITY — 50 SERIES UNITS

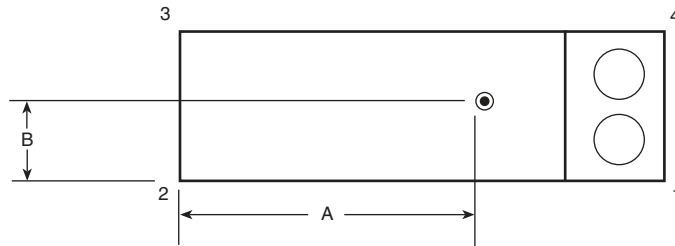

50P2,P3,P4,P5 UNITS	SIZE	CORNER WEIGHTS (lb)				TOTAL (lb)	A in.	B in.
		1	2	3	4			
50P2,P3 Vertical Supply/Return	030	1848	914	913	1845	5,519	159 ¹ / ₈	45 ⁷ / ₈
No Discharge Plenum	035	1901	935	934	1898	5,669	159 ³ / ₈	45 ⁷ / ₈
No Extended Chassis	040	1826	1281	1279	1824	6,210	186 ¹ / ₈	45 ⁷ / ₈
	050	1921	1293	1291	1919	6,425	189 ¹ / ₄	45 ⁷ / ₈
	055	2204	1914	1911	2201	8,230	212 ⁵ / ₈	45 ⁷ / ₈
	060	2215	1930	1928	2212	8,285	212 ¹ / ₄	45 ⁷ / ₈
	070	2984	1860	1452	2329	8,625	250 ¹ / ₂	40 ¹ / ₄
50P2,P3 Vertical Supply/Return	075	3219	2545	1987	2514	10,265	250 ¹ / ₈	40 ¹ / ₄
50P4,P5 Horizontal Supply/Return	090	3108	2839	2348	2570	10,865	258 ³ / ₈	41 ¹ / ₂
No Discharge Plenum, No Extended Chassis	100	3101	2857	2363	2564	10,885	257 ¹ / ₄	41 ¹ / ₂
50P2,P3 Vertical Supply/Return	030	1727	1184	1183	1725	5,819	152 ¹ / ₄	45 ⁷ / ₈
with Discharge Plenum and No Extended Chassis	035	1770	1217	1215	1768	5,969	152 ¹ / ₈	45 ⁷ / ₈
50P4,P5 Horizontal Supply/Return	040	1749	1508	1506	1746	6,510	180 ¹ / ₈	45 ⁷ / ₈
with No Extended Chassis	050	1842	1523	1521	1839	6,725	183 ⁵ / ₈	45 ⁷ / ₈
	055	2321	2072	2069	2318	8,780	231 ³ / ₄	45 ⁷ / ₈
	060	2331	2089	2087	2328	8,835	231 ¹ / ₄	45 ⁷ / ₈
	070	2847	2305	1800	2223	9,175	247 ¹ / ₂	40 ¹ / ₄

NOTE: The weight distribution and center of gravity information include the impact of an economizer, the largest indoor fan motor, and a VFD (variable frequency drive). On units with a return fan or high-capacity power exhaust, the largest motors and VFD are also included. These weights do not include the impact of other factory-installed options such as barometric relief, power exhaust, high-capacity indoor coil, hot water coil, or indoor fan.

WEIGHT DISTRIBUTION AND CENTER OF GRAVITY — 50 SERIES UNITS (cont)

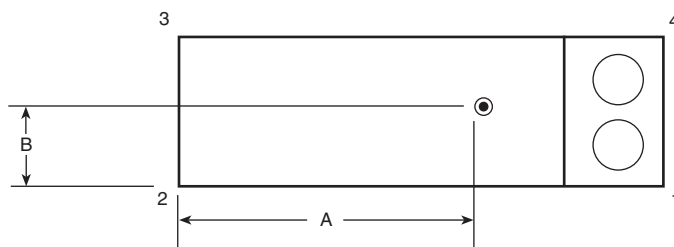

50P2,P3,P4,P5 UNITS	SIZE	CORNER WEIGHTS (lb)				TOTAL (lb)	A	B
		1	2	3	4		in.	in.
50P2,P3 Vertical Supply/Return with Extended Chassis	030	2009	1003	1002	2006	6,019	175 1/2	45 7/8
	035	2067	1019	1018	2064	6,169	176 1/8	45 7/8
	040	1992	1365	1363	1989	6,710	202 3/4	45 7/8
	050	2086	1378	1377	2084	6,925	205 7/8	45 7/8
	055	2350	2043	2040	2347	8,780	226	45 7/8
	060	2361	2060	2057	2357	8,835	225 5/8	45 7/8
	070	3159	1993	1556	2467	9,175	264 3/4	40 1/4
50P2,P3 Vertical Supply/Return with Extended Chassis 50P4,P5 Horizontal Supply/Return with Extended Chassis	075	3398	2676	2089	2653	10,815	264 5/8	40 1/4
	090	3282	2966	2453	2714	11,415	272 7/8	41 1/2
	100	3272	2987	2470	2706	11,435	271 5/8	41 1/2
50P2,P3 Vertical Supply/Return with Extended Chassis and Discharge Plenum 50P4,P5 Horizontal Supply/Return with Extended Chassis	030	1872	1290	1288	1869	6,319	166 7/8	45 7/8
	035	1919	1318	1316	1916	6,469	167 1/8	45 7/8
	040	1899	1608	1606	1896	7,010	195 1/4	45 7/8
	050	1992	1623	1620	1990	7,225	198 7/8	45 7/8
	055	2467	2201	2198	2464	9,330	245 1/8	45 7/8
	060	2476	2219	2216	2473	9,385	244 5/8	45 7/8
	070	2683	2183	2180	2679	9,725	260 3/4	45 7/8

50P2,P3,P4,P5 UNITS WITH OPTIONAL RETURN FAN	SIZE	CORNER WEIGHTS (lb)				TOTAL (lb)	A	B
		1	2	3	4		in.	in.
50P2,P3 Vertical Supply/Return 50P4,P5 Horizontal Supply/Vertical Return	075	3290	3405	2658	2568	11,921	220 1/8	40 1/4
	090	3166	3688	3049	2618	12,521	228 3/8	41 1/2
	100	3163	3702	3061	2615	12,541	227 3/4	41 1/2
50P2,P3 Vertical Supply/Return with Extended Chassis 50P4,P5 Horizontal Supply/Vertical Return with Extended Chassis	075	3430	3573	2790	2678	12,471	231 3/4	40 1/4
	090	3306	3849	3182	2734	13,071	240 1/8	41 1/2
	100	3299	3867	3198	2728	13,091	239 1/8	41 1/2

50P2,P3,P4,P5 UNITS WITH OPTIONAL HIGH-CAPACITY POWER EXHAUST	SIZE	CORNER WEIGHTS (lb)				TOTAL (lb)	A	B
		1	2	3	4		in.	in.
50P2,P3 Vertical Supply/Return 50P4,P5 Horizontal Supply/Vertical Return	075	4006	3350	2615	3128	13,099	287 1/8	40 1/4
	090	3857	3641	3010	3189	13,697	295 1/8	41 1/2
	100	3854	3655	3023	3187	13,719	294 3/8	41 1/2
50P2,P3 Vertical Supply/Return with Extended Chassis 50P4,P5 Horizontal Supply/Vertical Return with Extended Chassis	075	6709	956	746	5238	13,649	483 1/2	40 1/4
	090	6308	1491	1233	5216	14,247	484 3/8	41 1/2
	100	6441	1370	1133	5326	14,269	493 7/8	41 1/2

LEGEND

PE — Power Exhaust

NOTE: The weight distribution and center of gravity information include the impact of an economizer, the largest indoor fan motor, and a VFD (variable frequency drive). On units with a return fan or high-capacity power exhaust, the largest motors and VFD are also included. These weights do not include the impact of other factory-installed options such as barometric relief, power exhaust, high-capacity indoor coil, hot water coil, or indoor fan.

Physical data (cont)



OPERATING WEIGHTS OF OPTIONS AND ACCESSORIES (lb)

OPTION OR ACCESSORY	48/50P UNIT SIZE							
	030,035	040,050	055	060	070	075	090	100
Electric Heat*	140	140	140	140	140	250	250	250
Condenser Section Roof Curb	—	—	540	540	625	625	625	625
Economizer	300†	300†	530†	530†	530†	530†	530†	530†
Power Exhaust (PE)	710†	710†	710†	710†	710†	710†	710†	710†
Barometric Relief	200	200	200	200	200	200	200	200
Double Wall Construction	700	800	900	900	900	900	900	900
Roof Curb								
48P Standard Length	455	495	605	605	605	605	605	605
48P Extended Length	545	545	1200	1200	—	—	—	—
48P with High Capacity PE	—	—	—	—	—	700	700	700
50P Standard Length	390	480	560	560	560	605	605	605
50P with Discharge Plenum	455	495	605	605	605	605	605	605
50P Extended Length	545	545	545	545	545	—	—	—
50P Extended Length with Discharge Plenum	545	545	1200	1200	—	—	—	—
50P with High Capacity PE	—	—	—	—	—	700	700	700
High-Efficiency Filters	20	20	20	20	20	20	20	20
Bag Filters, Cartridge Filters	35	35	40	40	40	—	—	—
Hail Guard	—	150	145	145	—	—	—	—
Variable Frequency Drive								
7.5 hp	20	20	20	20	20	20	20	20
10 hp	20	20	20	20	20	20	20	20
15 hp	35	35	35	35	35	35	35	35
20 hp	35	35	35	35	35	35	35	35
25 hp	53	53	53	53	53	53	53	53
30 hp	53	53	53	53	53	53	53	53
40 hp	53	53	53	53	53	53	53	53
50 hp	53	53	53	53	53	53	53	53
60 hp	53	53	53	53	53	53	53	53
75 hp	152	152	152	152	152	152	152	152
High-Capacity Evaporator Coil	150	300	300	300	300	300	300	300
Airfoil Fan	—	—	—	—	—	350	350	350
Humidi-MiZer® Adaptive Dehumidification System	72	72	72	72	72	72	92	92
Hot Water Coil*	150	150	180	180	180	180	180	180

*50 series units only.

†Includes hood.

Options and accessories



ITEM	OPTION*	ACCESSORY†	SPECIAL ORDER**
GAS HEAT (48P units only)			
Low Gas Heat — Aluminized Heat Exchanger	X		
High Gas Heat — Aluminized Heat Exchanger	X		
Low Gas Heat — Stainless Steel Heat Exchanger	X		
High Gas Heat — Stainless Steel Heat Exchanger	X		
Staged Low Gas Heat — Stainless Steel Heat Exchanger	X		
Staged High Gas Heat — Stainless Steel Heat Exchanger	X		
Modulating Low Gas Heat — Stainless Steel Heat Exchanger	X		
Modulating High Gas Heat — Stainless Steel Heat Exchanger	X		
ELECTRIC HEAT (50P units only)			
Staged Electric Heat	X		
SCR Controlled Electric Heat	X		X
HYDRONIC HEAT (50P units only)			
2-Row Hot Water Coil	X		
Modulating Hot Water Control Valve		X	
Steam Coil			X
INDOOR AIR QUALITY			
Double Wall Construction in Airstream	X		
AgION® Double Wall Construction in Airstream			X
Outdoor Air cfm Station	X		
MERV 7 Pleated, 2-in. Filter Package	X		
MERV 11 Pleated, 2-in. Filter Package (sizes 075-100 only)	X		
MERV 14 Bag Filter Package with Integral 2-in. Prefilters (sizes 030-070 only)	X		
12 in. Cartridge Filter with Integral 2-in. Thick Prefilters (sizes 030-070 only)	X		
MERV 8 2-in. Thick Filter Kit		X	
MERV 8 4-in. Thick Filter Kit ††		X	
MERV 11 4-in. Thick Filter Kit ††		X	
MERV 13 4-in. Thick Filter Kit ††		X	
MERV 14 4-in. Thick Filter Kit ††		X	
MERV 14, 12-in. Cartridge Filter Kit (sizes 030-070 only)		X	
UV Lamps (with Door Interlocks and Disconnect Switch)			X
ECONOMIZER			
Manual Outside-Air, Self-Closing Damper	X		
Enthalpy Control Economizer	X		
Ultra Low Leak Economizer	X		
Outdoor or Return Humidity Sensor (Enthalpy)		X	
EXHAUST AIR CONTROL			
Barometric Relief	X		
Non-Modulating Power Exhaust	X		
Modulating Power Exhaust with VFD	X		
Modulating Power Exhaust with VFD and Bypass	X		
High-Capacity Power Exhaust with VFD (sizes 075-100 only)	X		
Return Fan with VFD (sizes 075-100 only)	X		
Shaft Grounding Ring for PE or RF Motors			X
CONDENSER AND EVAPORATOR COIL			
Al/Al E-Coat Novation® MCHX Condenser Coil	X		
High-Capacity Evaporator Coil	X		
Pre-Coat Al/Cu Evaporator Coil			X
E-Coat Al/Cu Evaporator Coil			X
Cu/Cu Evaporator Coil			X
Hot Gas Bypass (Circuit A)	X		
Condenser Coil Hail Guard Assembly (sizes 040-060 only)		X	
Humidi-MiZer® Adaptive Dehumidification System	X		
Security Grille (sizes 070-100 only)	X		
Low Outdoor Sound	X		
POWER CIRCUIT			
Split Power (exceptions may apply)			X
GFI Convenience Outlet (Powered on Load-Side)	X		
GFI Convenience Outlet (Non-Powered)			X
Power Terminal Block	X		
Non-Fused Disconnect	X		
Disconnect with UL489 Circuit Breaker (HACR)			X
Fused Disconnect			X
Phase Protection Monitor			X
65KA Short Circuit Current Rating (208,230,460 volt)	X		
25KA Short Circuit Current Rating (575 volt only)	X		

Options and accessories (cont)



ITEM	OPTION*	ACCESSORY†	SPECIAL ORDER**
CONTROLS			
Controls Expansion Module (CEM)	X	X	
BACnet Communication	X		
System Pilot™ Interface		X	
Touch Pilot™ Interface		X	
Navigator™ Display		X	
Return Air CO ₂ Sensor		X	
CO ₂ Space Sensor		X	
Return Air Smoke Detector		X	
Return and Supply Air Smoke Detectors Installed			X
Filter Switch		X	
Fan Status Switch (requires CEM)		X	
T-55 Space Temperature Sensor with Override		X	
T-56 Space Temperature Sensor with Override and Set Point Adjustment		X	
Space Temperature Sensor with CO ₂ Override		X	
Space Temperature Sensor with CO ₂ Override and Set Point Adjustment		X	
MODBUS Carrier Translator		X	
LonWorks Carrier Translator		X	
INDOOR FAN AND MOTOR			
Bypass on IFM VFD	X		
Airfoil Fan (sizes 075-100 only)	X		
Shaft Grounding Ring for IFM			X
Extended Lube Lines			X
PACKAGING			
Domestic	X		
Export	X		
AIRFLOW CONFIGURATIONS			
Vertical Supply / Vertical Return	X		
Horizontal Supply / Horizontal Return	X		
Horizontal Supply / Vertical Return			X
Vertical Supply / Horizontal Return			X
Opposite Side Supply - Cooling Only or Hydronic Heat			X
Extended Chassis	X		
COMPRESSION			
Digital Compressor	X		
Low Compressor Sound		X	
Low Ambient Control	X	X	
Refrigeration Service Valves	X		
Replacable Core Filter Drier	X		
MISCELLANEOUS			
14-in. Roof Curb		X	
Condenser Section Roof Curb (sizes 070-100 only)		X	
Access Door Retainers			X
Double Wall on Bottom (not compatible with roof curb)			X

LEGEND

Al	—	Aluminum
Cu	—	Copper
ETO	—	Engineered-To-Order
HACR	—	Heating, Air Conditioning and Refrigeration
GFI	—	Ground Fault Interrupt
IFM	—	Indoor Fan Motor
MCHX	—	Microchannel Heat Exchanger
PE	—	Power Exhaust
RF	—	Return Fan
SCR	—	Silicon Controlled Rectifier
UVC	—	Ultraviolet
VFD	—	Variable Frequency Drive

*Factory installed.

†Field installed.





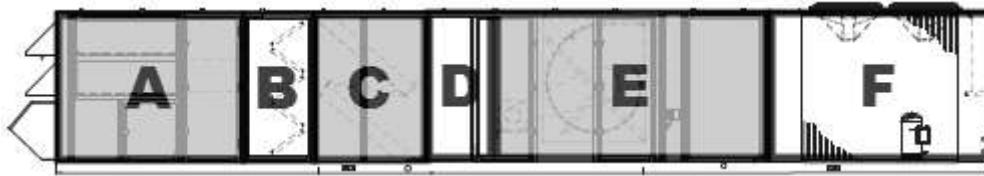

**A special order is offered to meet specific customer requirements. Quotations for special order options can be requested via the Carrier ETO process. Lead times and prices vary with the option.

†† Standard 2-in. filter track may be field converted to accept 4-in. filters.

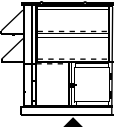
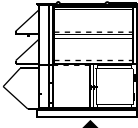
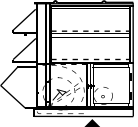
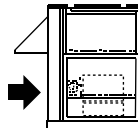
REPRESENTATIVE UNIT SELECTION UNIT SIZES 030-070

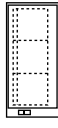

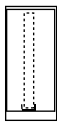
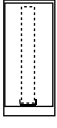
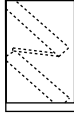
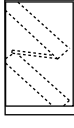
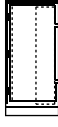
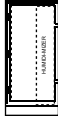
Representative Unit Selection (Exceptions Apply)

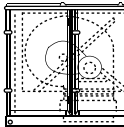
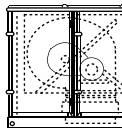
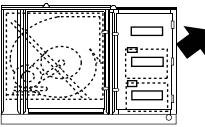
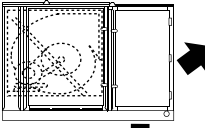
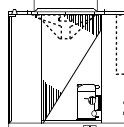
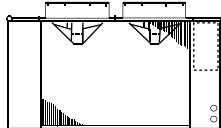
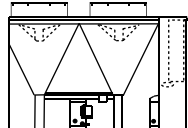
A Mandatory Return Section	B Mandatory Mixed Air Filter Section	C Mandatory DX Coil Section	D Optional Extended Chassis	E Mandatory Supply Fan + Elec/Gas Heat Section + Optional Plenum	F Mandatory Condensing Section
<p>Manual Damper</p>  <p>↑</p> <p>Economizer with Barometric Relief (Bottom Return)</p>  <p>↑</p> <p>Economizer with PE (Bottom Return)</p>  <p>↑</p> <p>Economizer with PE (End Return)</p>  <p>→</p>	<p>Pleated Filters</p>  <p>Cartridge Filters</p>  <p>Bag Filters</p> 	<p>Sizes 030-035 Std Evap Coil</p>  <p>Sizes 030 High Capacity Evap Coil</p>  <p>Size 040-070 Std Evap Coil</p>  <p>Sizes 040-070 High Capacity Evap Coil</p> 	<p>Blank Extended Chassis</p>  <p>Humidi-MiZer Dehumidification System</p>  <p>Hydronic Heat Coil</p> 	<p>FC Fan + No Elec/Gas Heat (Bottom Supply)</p>  <p>↓</p> <p>FC Fan + Elect Heat (Bottom Supply)</p>  <p>↓</p> <p>FC Fan + Gas Heat (Bottom or Side Supply, Far Side)</p>  <p>↓</p> <p>FC Fan + No Elect/Gas Heat + Plenum (Bottom or Side Supply, Far Side)</p>  <p>↓</p>	<p>Size 030-035</p>  <p>Size 040-060</p>  <p>Size 070</p> 

LEGEND

- AF — Air Foil
- FC — Forward Curve
- PE — Power Exhaust





Options and accessories (cont)



REPRESENTATIVE UNIT SELECTION UNIT SIZES 075-100

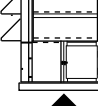
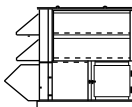
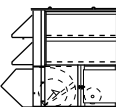
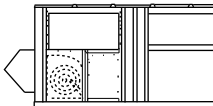
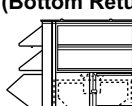
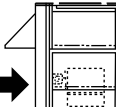
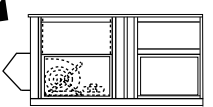

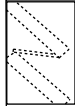
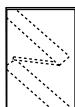
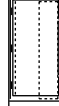
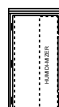
Representative Unit Selection (Exceptions Apply)

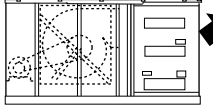
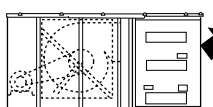
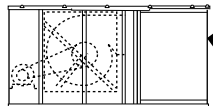
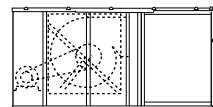
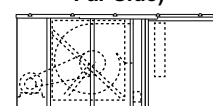
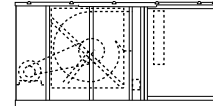
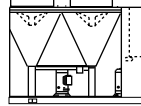
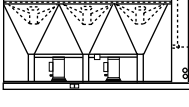
A Mandatory Return Section	B Mandatory Mixed Air Filter Section	C Mandatory DX Coil Section	D Optional Extended Chassis	E Mandatory Supply Fan + Elec/Gas Heat Section	F Mandatory Condensing Section
<p>Manual Damper</p>  <p>Economizer with Barometric Relief (Bottom Return)</p>  <p>Economizer with PE (Bottom Return)</p>  <p>Economizer with High Capacity PE (Bottom Return)</p>  <p>Economizer with Return Fan (Bottom Return)</p>  <p>Economizer with PE (End Return)</p>  <p>Economizer with High Capacity PE (Side Return, Far Side)</p> 	<p>Pleated Filters</p> 	<p>Std Evap Coil</p>  <p>High Capacity Evap Coil</p> 	<p>Blank Extended Chassis</p>  <p>Humidi-MiZer Dehumidification System</p>  <p>Hydronic Heat Coil</p> 	<p>FC Fan + Gas Heat (Bottom or Side Supply, Far Side)</p>  <p>AF Fan + Gas Heat (Bottom or Side Supply, Far Side)</p>  <p>FC Fan + No Elec/Gas Heat + Plenum (Bottom or Side Supply, Far Side)</p>  <p>AF Fan + No Elec/Gas Heat (Bottom or Side Supply, Far Side)</p>  <p>AF Fan + Elec Heat (Bottom or Side Supply, Far Side)</p>  <p>FC Fan + Elec Heat (Bottom Supply)</p> 	<p>Size 075</p>  <p>Size 090-100</p> 

CHASSIS ARRANGEMENTS (48 Series units)

Standard length chassis with vertical discharge —

The standard, compact, vertical discharge arrangement is provided with a bottom, return-air opening, straight-through air path, and horizontal discharge into the heating section with bottom supply air outlet. Ductwork is attached to accessory roof curb. These units are available with factory-installed optional power exhaust or barometric relief packages in conjunction with factory-installed optional economizers.

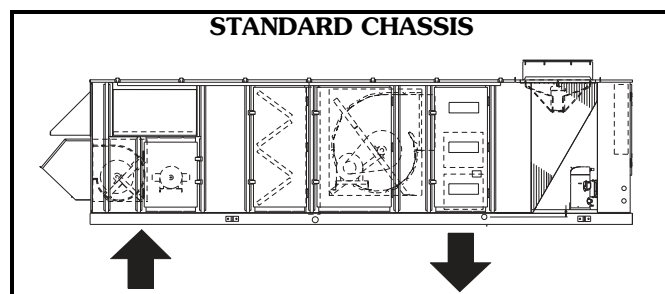

Vertical discharge with optional return fan —

This vertical discharge arrangement adds a factory-installed return fan and VFD. Return air enters through the bottom opening upstream of the return fan and follows a straight-through path to the supply fan and into the heating section, where it exits through the bottom supply air outlet. Ductwork is attached to the accessory roof curb.

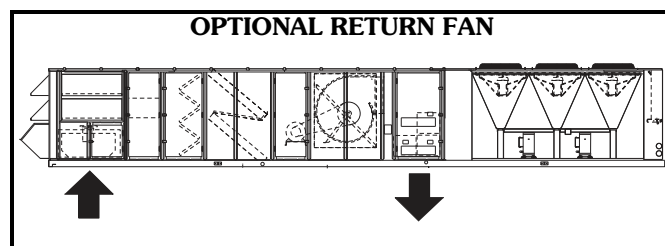

Extended length chassis with vertical discharge —

The extended length chassis arrangement provides an additional 25-in. of unit length located between the evaporator coil section and the supply fan sled. This compartment is used for field-installation of an auxiliary coil. The auxiliary coil can be a hydronic heating coil, a steam heating coil, or a refrigeration heat reclaim coil. The extended length compartment includes tracks to accept the field-supplied and installed auxiliary coil.

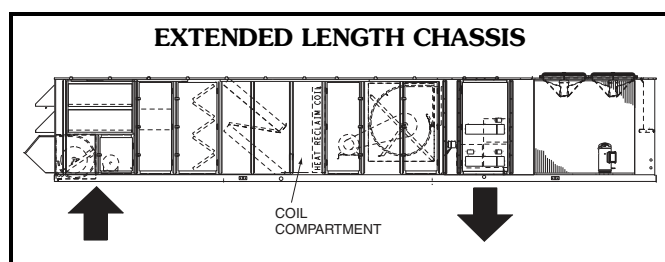

Vertical discharge with optional high-capacity modulating power exhaust system —

This vertical discharge arrangement adds a factory-installed extended rear plenum to house the integrated economizer and high-capacity modulating power exhaust systems (standard features on these models). Return air enters unit through bottom opening upstream of the power exhaust system and follows a straight-through path to the supply fan and into the heating section, where it exits unit through bottom supply air outlet. Ductwork is attached to accessory roof curb.

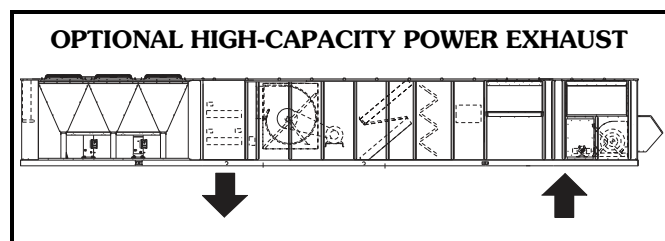

Options and accessories (cont)



CHASSIS ARRANGEMENTS (50 Series units)

Standard length chassis with vertical discharge —

The standard, compact, vertical discharge arrangement is provided with a bottom return-air opening, straight-through air path, and direct, vertical-discharge, supply fan for bottom supply air. Ductwork is attached to accessory roof curb. These units are available with factory-installed optional electric heat. Factory-installed optional power exhaust is available in conjunction with factory-installed optional economizer.

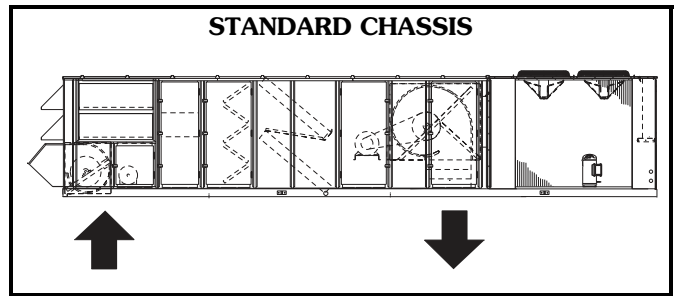

Vertical discharge with optional return fan —

This vertical discharge arrangement adds a factory-installed return fan with VFD and extended rear plenum. Return air enters unit through bottom opening upstream of the return fan and follows a straight-through path to the supply fan and into the extended plenum section, where it exits unit through bottom supply air outlet. Ductwork is attached to accessory roof curb. Return air exhaust outlet is on the end of the chassis. Factory-installed optional electric heat is available on these units.

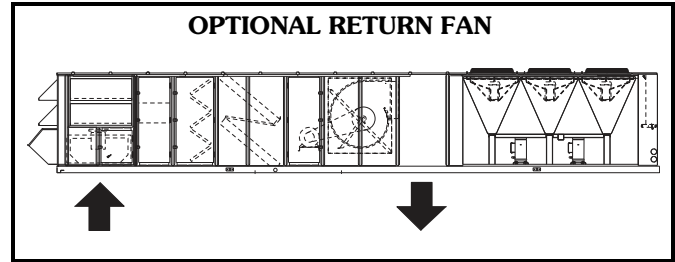

Standard length chassis with vertical discharge and discharge plenum —

The standard, vertical discharge arrangement is provided with a bottom, return-air opening, straight-through air path. The supply fan is arranged for horizontal outlet into the discharge plenum area. Supply air exits from the discharge plenum area downward through the bottom of the unit. Ductwork is attached to accessory roof curb. These units are available with factory-installed optional power exhaust or barometric relief packages in conjunction with factory-installed optional economizers.

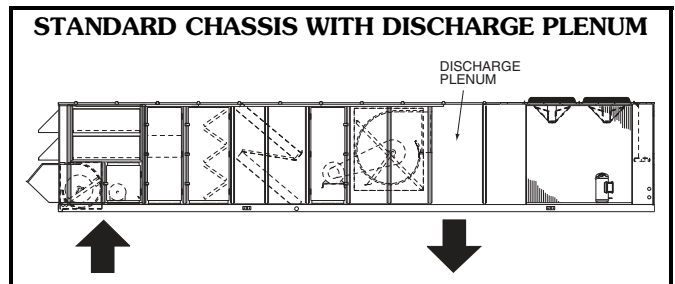

Standard length chassis with horizontal discharge —

The standard, compact, horizontal discharge arrangement is provided with a return-air end opening, straight-through air path, and supply-air discharge on the unit left hand side. Ductwork is attached to flanges on the outer cabinet. Electric heaters are not available on size 030-070 units. Factory-installed optional economizers are available. Factory-installed power exhaust is available.

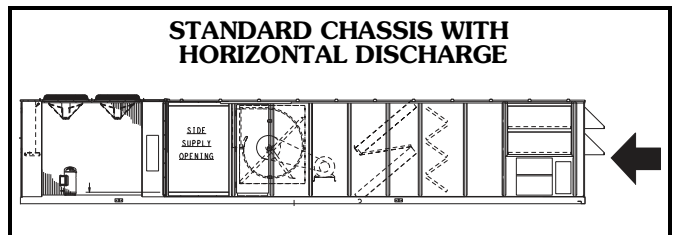

Vertical discharge with optional high-capacity modulating power exhaust systems —

This vertical discharge arrangement adds a factory-installed extended rear plenum to house the integrated economizer and high-capacity modulating power exhaust systems (standard features on these models). Return air enters unit through bottom opening upstream of the power exhaust system and follows a straight-through path to the supply fan and into the extended plenum section, where it exits unit through bottom supply air outlet. Ductwork is attached to accessory roof curb. Economizer inlets are on both sides of the unit; power exhaust outlet is on the end of the chassis. Factory-installed optional electric heat is available on these units.

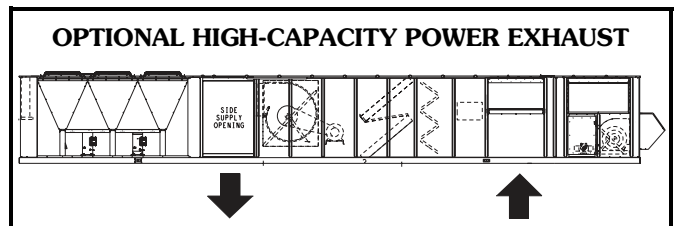

CHASSIS ARRANGEMENTS (50 Series units) (cont)

Horizontal discharge with optional high-capacity modulating power exhaust systems — This horizontal discharge arrangement adds a factory-installed extended rear plenum to house the integrated economizer and high-capacity modulating power exhaust systems (standard features on these models). Return air enters the chassis through dual openings on the left-hand side of unit. The supply fan discharges horizontally into the extended plenum section with unit supply air outlet on the left-hand side. Ductwork is attached to flanges on the outer cabinet. Economizer inlets are on both sides of the unit; power exhaust outlet is on the end of the chassis.

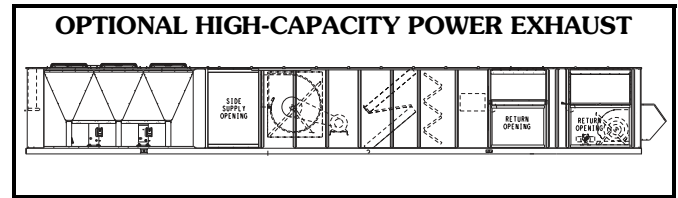

Horizontal discharge with optional return fan and modulating exhaust damper — This horizontal discharge arrangement adds a factory-installed return fan with VFD and extended rear plenum. Return air enters the chassis through the bottom opening upstream of the return fan. The supply fan discharges horizontally into the extended plenum section with unit supply air outlet on the left-hand side. Ductwork is attached to flanges on the outer cabinet. Return air exhaust outlet is on the end of the chassis.

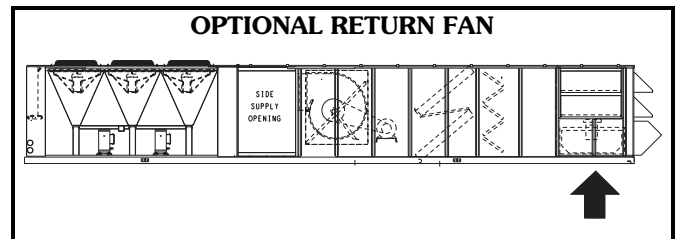

Extended length chassis with vertical discharge — The extended length, vertical discharge arrangement is provided with a bottom, return-air opening, straight-through air path, and direct, vertical-discharge, supply fan for bottom supply air. Ductwork is attached to accessory roof curb. These units are available with factory-installed optional power exhaust or barometric relief packages in conjunction with factory-installed optional economizers.

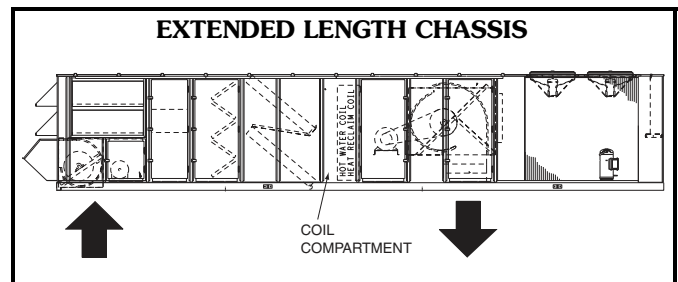

Extended length chassis with horizontal discharge — The extended length horizontal discharge arrangement is provided with a return-air end opening, straight-through air path, and supply-air discharge on the unit left hand side. Ductwork is attached to flanges on the outer cabinet. Electric heaters and barometric relief packages are not available on these units. Factory-installed optional economizers are available. Factory-installed optional power exhaust is available.

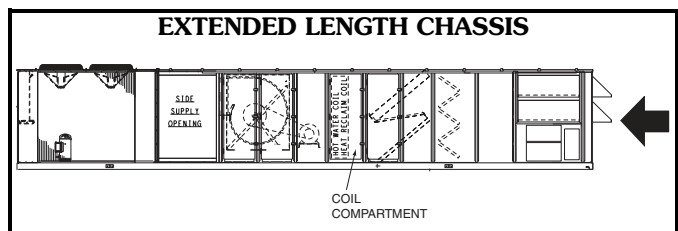

Base unit dimension examples

48P4, P5030, 035 UNIT

NOTES:

1. DIMENSIONS IN () ARE IN MILLIMETERS.
2. UNIT HEIGHT AND CENTER OF GRAVITY INCLUDES ECONOMIZER, ECONOMIZER END, 6"-0" EXCEPT POWER EXHAUST UNITS 10"-0" EXCEPT LOW CAPACITY EMULATOR COIL.
3. UNIT CLEARANCES:
 TOP AND RESTRICT CONDENSER FANS: 6"-0"
 SIDES: 6"-0"
 FRONT: 6"-0"
4. ECONOMIZER END - 6"-0" EXCEPT POWER EXHAUST UNITS 10"-0" EXCEPT LOW CAPACITY EMULATOR COIL.
5. SUGGESTED FIELD CONNECTIONS TO BE MADE INSIDE OR OUTSIDE OF 32.5 mm FLANGE.
6. WHEN THE UNIT IS SLAB MOUNTED, PLUG THE DRAIN HOLES AND AUXILIARY CONDENSATE DRAIN HOLES. SIDE HOODS ARE FOLDED INSIDE UNIT FOR SHIPPING.

UNIT SIZE	WEIGHT		A		B	
	LBS.	KGS.	MM	FT. IN.	MM	FT. IN.
030 LOW HEAT	6019	2730	4334	14'-2 5/8"	1164	3'-9 13/16"
030 HIGH HEAT	6149	2789	4310	14'-1 11/16"	1164	3'-9 13/16"
035 LOW HEAT	6169	2798	4342	14'-2 15/16"	1164	3'-9 13/16"
035 HIGH HEAT	6299	2857	4319	14'-2"	1164	3'-9 13/16"

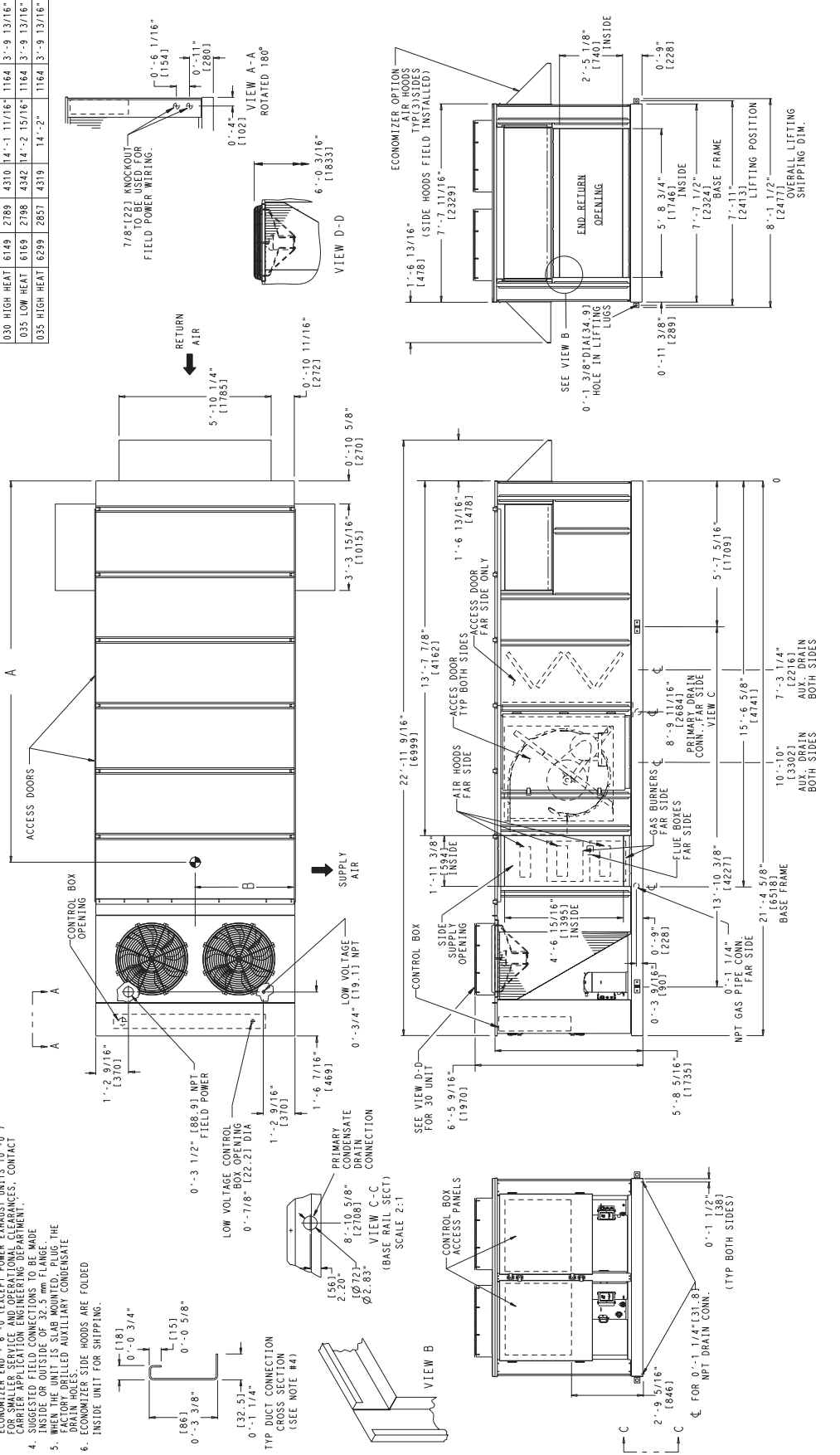

This section details eight examples of the P Series large rooftop unit. To determine dimensions for the appropriate unit for your application, refer to the Applied Rooftop Builder software.

50P2,P3030,035 UNITS (UNIT WITH OPTIONAL EXTENDED PLENUM SHOWN)

- NOTES:
1. DIMENSIONS IN () ARE IN MILLIMETERS.
 2. UNIT WEIGHT AND CENTER OF GRAVITY INCLUDES ECONOMIZER.
 3. LARGEST INDOOR FAN MOTOR AND HIGH CAPACITY EVAPORATOR COIL CONTROL NOT RESTRICT CONDENSER FANS.
 4. ECONOMIZER END () EXCEPT POWER EXHAUST UNITS () . CONTACT CARRIER APPLICATION ENGINEERING DEPARTMENT.
 5. DOWNSHOT DUCTS DESIGNED TO BE ATTACHED TO ACCESSORY ROOF CURB. IF UNIT IS MOUNTED ON DOWNGAGE IT IS RECOMMENDED THE ACCESSORY ROOF CURB BE BRACED BY CROSS BRACES WHEN THE UNIT IS SLAB MOUNTED. PLUG THE FACTORY DRILLED AUXILIARY CONDENSATE DRAIN HOLES.
 6. ECONOMIZER SIDE HOODS ARE FOLDED INSIDE UNIT FOR SHIPPING.

UNIT SIZE	WEIGHT		A		B	
	LBS.	KGS.	MM	FT. IN.	MM	FT. IN.
030	5819	2640	3867	12'-8 1/4"	1164	3'-9 13/16"
035	5969	2708	3863	12'-8 1/16"	1164	3'-9 13/16"

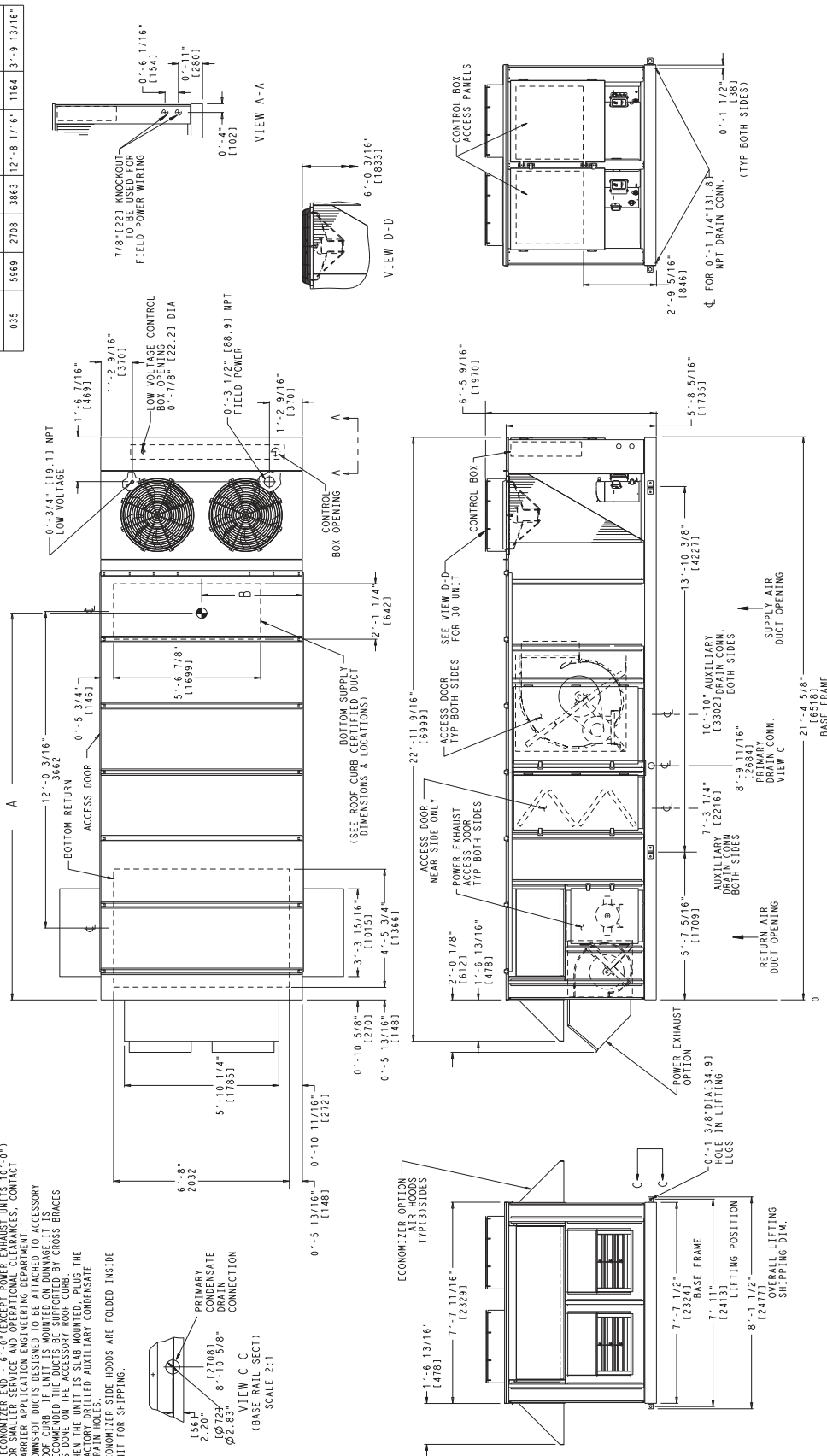

This section details eight examples of the P Series large rooftop unit. To determine dimensions for the appropriate unit for your application, refer to the Applied Rooftop Builder software.

50P2,P3055,060 UNITS

- NOTES:
1. DIMENSIONS IN () ARE IN MILLIMETERS.
 2. UNIT WEIGHT AND CENTER OF GRAVITY INCLUDES ECONOMIZER, LARGEST INDOOR FAN MOTOR AND HIGH CAPACITY EVAPORATOR COIL.
 3. UNIT CLEARANCES
TOP - DO NOT RESTRICT CONDENSER FANS
CONTROL BOX END - 6'-0"
 4. FOR SMALLER SERVICE AND OPERATIONAL CLEARANCES, CONTACT CARRIER APPLICATION ENGINEERING DEPARTMENT.
 5. DOWNPOUR DUCTS DESIGNED TO BE ATTACHED TO ACCESSORY ROOF CURB. DOWNPOUR DUCTS SHOULD BE SUPPORTED BY CROSS BRACES AS DONE ON THE ACCESSORY ROOF CURB.
 6. WHEN THE UNIT IS SLAB MOUNTED, PLUG THE FACTORY DRILLED AUXILIARY CONDENSATE DRAIN HOLES.
 7. ECONOMIZER SIDE HOODS ARE FOLDED INSIDE UNIT FOR SHIPPING.

UNIT SIZE	WEIGHT LBS.	MM	A FT. IN.	MM	B FT. IN.	MM	C FT. IN.	MM	D FT. IN.	MM	E FT. IN.	F FT. IN.		
055	8230	3733	2864	9'-4 3/4"	5363	17'-7 1/8"	5401	17'-8 5/8"	1163	3'-9 13/16"	10108	33'-1 15/16"	10492	34'-5 1/16"
060	8285	3758	2864	9'-4 3/4"	5383	17'-7 1/8"	5392	17'-8 5/16"	1163	3'-9 13/16"	10108	33'-1 15/16"	10492	34'-5 1/16"

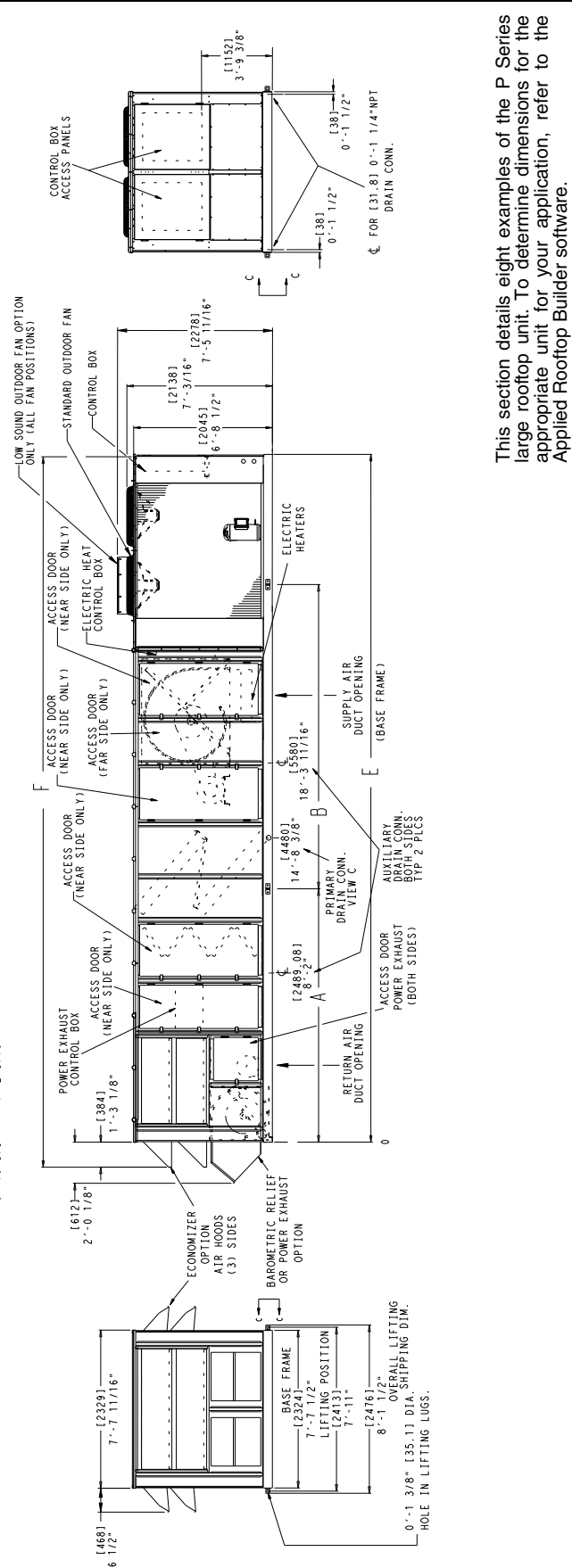
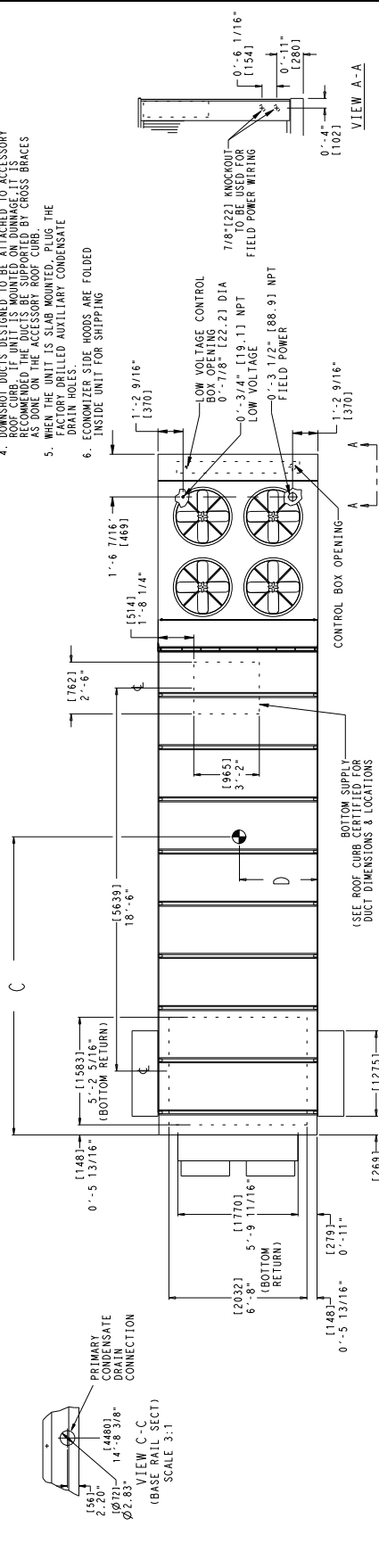

This section details eight examples of the P Series large rooftop unit. To determine dimensions for the appropriate unit for your application, refer to the Applied Rooftop Builder software.

ROOF CURB — SIZES 030-050

- NOTES:
1. ROOF CURB IS SHIPPED DISASSEMBLED.
 2. ROOF CURB: 14 GA. (14A03-56) STL.
 3. DIMENSIONS IN () ARE MILLIMETERS.

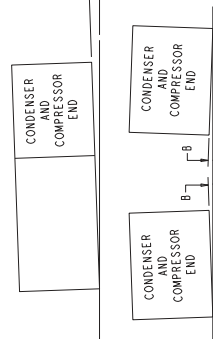
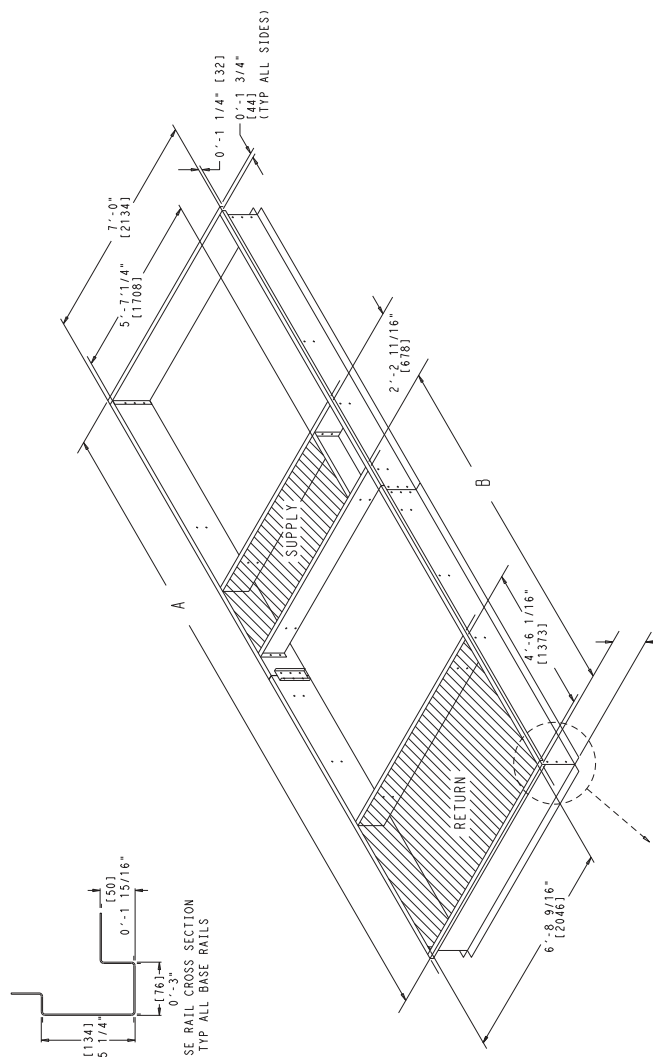
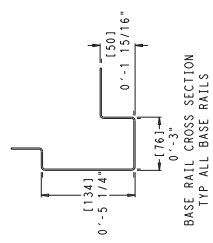

DIMENSIONS
(degrees and inches)

A	B
DEG.	IN.
1.0	2.0
.50	.75

UNIT LEVELING TOLERANCES
*From edge of unit to horizontal.

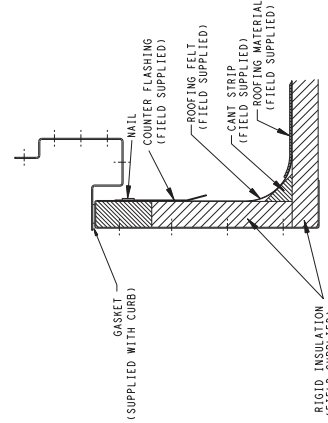

UNIT TYPE	DIMENSION	UNIT SIZE
5-P VERTICAL SUPPLY & RETURN	A	030-035
	B	040-050
5-P VERTICAL SUPPLY & RETURN W/EXTENDED CHASSIS	A	19'-2 3/8"
	B	25'-9 5/8"
4B/50P VERTICAL & HORIZONTAL SUPPLY & RETURN W/EXTENDED PLENUM	A	10-10 3/8"
	B	13-7 1/8"
4B/50P VERTICAL & HORIZONTAL SUPPLY & RETURN W/EXTENDED CHASSIS & PLENUM	A	21-3 9/16"
	B	27-10 13/16"
4B/50P VERTICAL & HORIZONTAL SUPPLY & RETURN W/EXTENDED CHASSIS & PLENUM	A	12-11 9/16"
	B	15-8 7/32"
4B/50P VERTICAL & HORIZONTAL SUPPLY & RETURN W/EXTENDED CHASSIS & PLENUM	A	10-3 1/8"
	B	16'-5 5/8"
4B/50P VERTICAL & HORIZONTAL SUPPLY & RETURN W/EXTENDED CHASSIS & PLENUM	A	22'-10 1/4"
	B	29'-5 13/16"
4B/50P VERTICAL & HORIZONTAL SUPPLY & RETURN W/EXTENDED CHASSIS & PLENUM	A	15'-4 7/8"
	B	18-1 7/8"

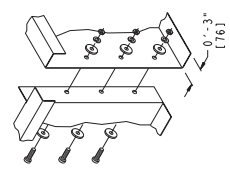

(CORNER CONNECTIONS AND SPLICE PLATE CONNECTIONS)

ROOF CURB — SIZES 055,060

- NOTES:
1. ROOF CURB IS SHIPPED DISASSEMBLED.
 2. ROOF CURB: 14 GA. [VA03-56] STL.
 3. DIMENSIONS IN () ARE MILLIMETERS.

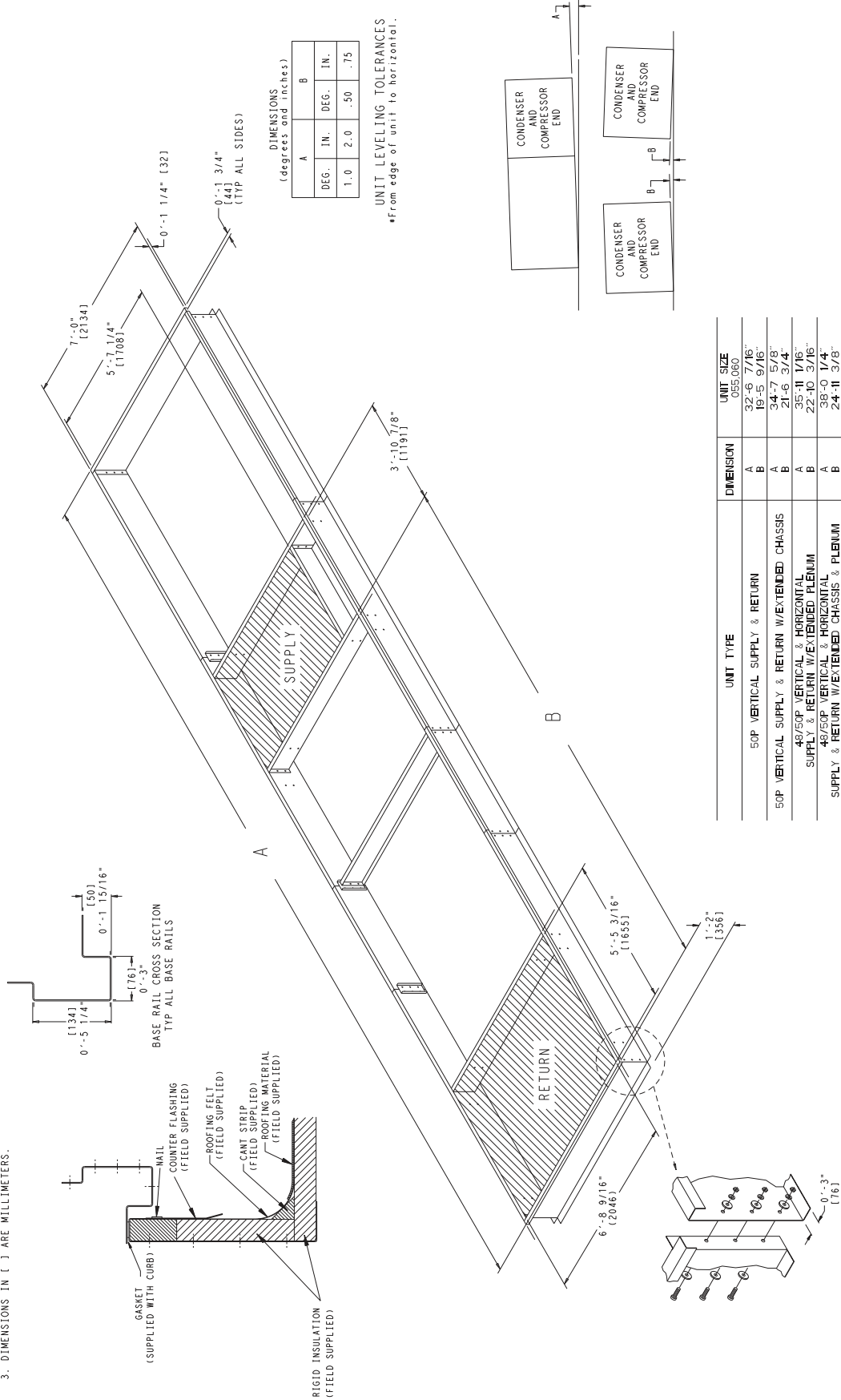

(CORNER CONNECTIONS AND SPLICE PLATE CONNECTIONS)

Accessory dimensions (cont)

ROOF CURB — SIZES 070-100

- NOTES:
1. ROOF CURB ACCESSORY IS SHIPPED DISASSEMBLED.
 2. ROOF CURB: 14 GA. (VA03-56) STL.
 3. DIMENSIONS IN () ARE MILLIMETERS.
 4. SUGGESTED HOLE LOCATION FOR FIELD WIRING THROUGH ROOF CURB(HOLES TO BE SUPPLIED BY FIELD).

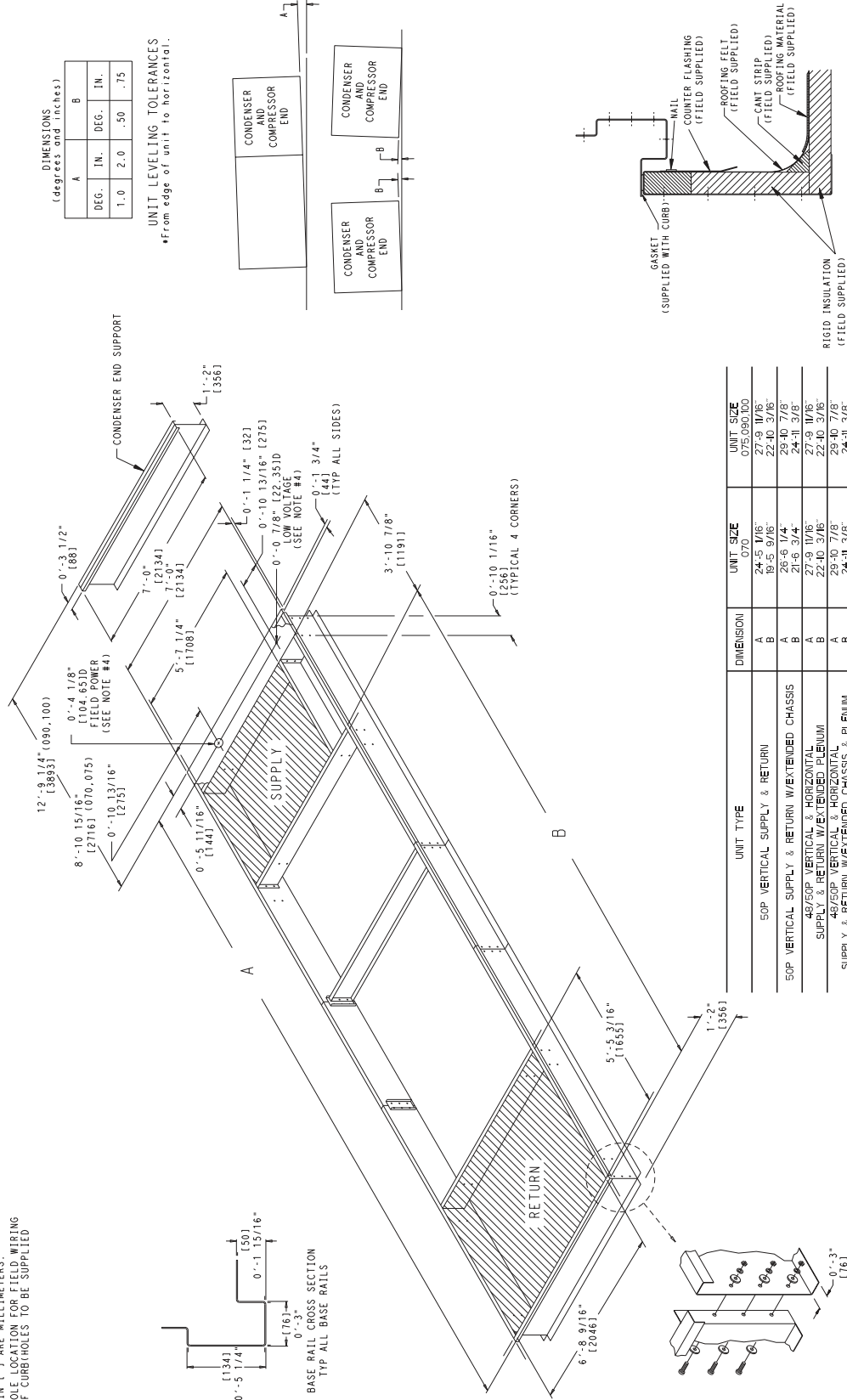

DIMENSIONS
(degrees and inches)

A	B
DEG.	IN.
1.0	2.0
	.50
	.75

UNIT LEVELING TOLERANCES
*From edge of unit to horizontal.

UNIT TYPE	DIMENSION	UNIT SIZE	UNIT SIZE
EOP VERTICAL SUPPLY & RETURN	A	070	075/090/100
	B	24-5 9/16" (226)	27-8 11/16" (256)
	A	26-5 9/16" (256)	29-10 7/8" (256)
	B	24-11 3/8" (256)	27-5 11/16" (256)
48/50P VERTICAL & HORIZONTAL SUPPLY & RETURN W/EXTENDED PLENUM	A	27-5 11/16" (256)	27-5 11/16" (256)
	B	22-10 3/16" (256)	22-10 3/16" (256)
48/50P VERTICAL & HORIZONTAL SUPPLY & RETURN W/EXTENDED CHASSIS & PLENUM	A	29-10 7/8" (256)	29-10 7/8" (256)
	B	24-11 3/8" (256)	24-11 3/8" (256)

CONDENSER SECTION ROOF CURB — SIZES 070 AND 075

- NOTES:
1. ROOF CURB ACCESSORY CRRFCURB070A00 IS SHIPPED DISASSEMBLED.
 2. DIMENSIONS IN () ARE MILLIMETERS.
 3. ROOF CURB: 14 GA. (VA03-56) STL.
ROOF CURB PANS: 16 GA. (VA03-56) STL.

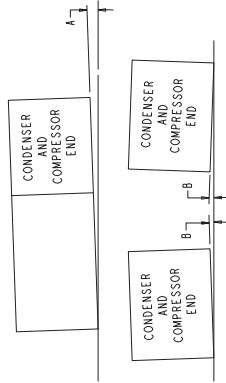

DIMENSIONS
(degrees and inches.)

A	B
DEG. IN.	DEG. IN.
1.0 2.0	.50 .75

UNIT LEVELING TOLERANCES
*From edge of unit to horizontal.

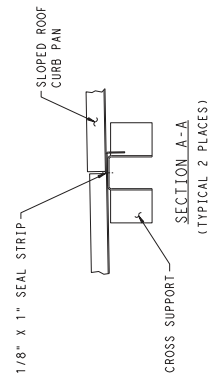
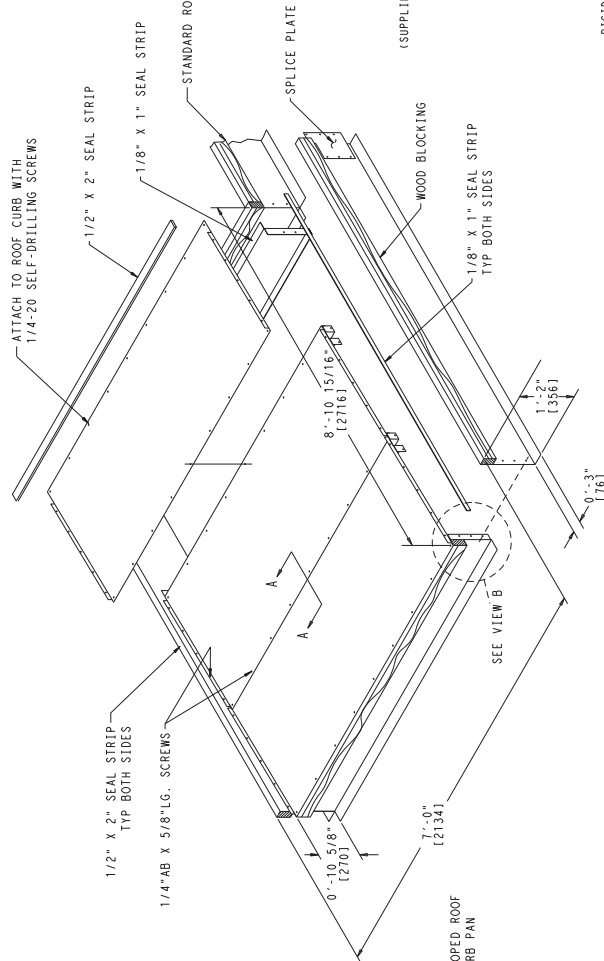
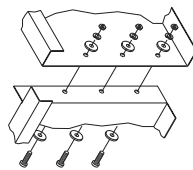
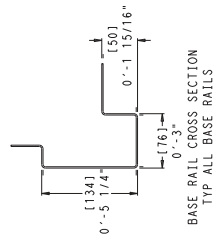
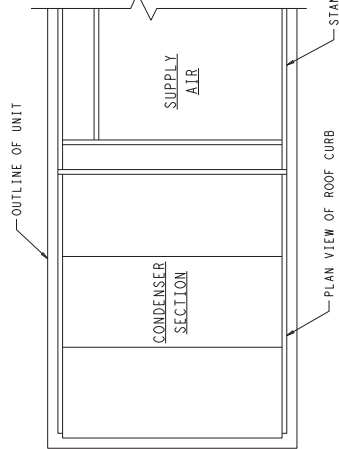

Accessory dimensions (cont)

CONDENSER SECTION ROOF CURB — SIZES 090 AND 100

- NOTES:
1. ROOF CURB ACCESSORY CRRFB071A00 IS SHIPPED DISASSEMBLED.
 2. DIMENSIONS IN [] ARE MILLIMETERS.
 3. ROOF CURB: 14 GA. [VA03-56] STL.
ROOF CURB PANS: 16 GA. [VA03-56] STL.

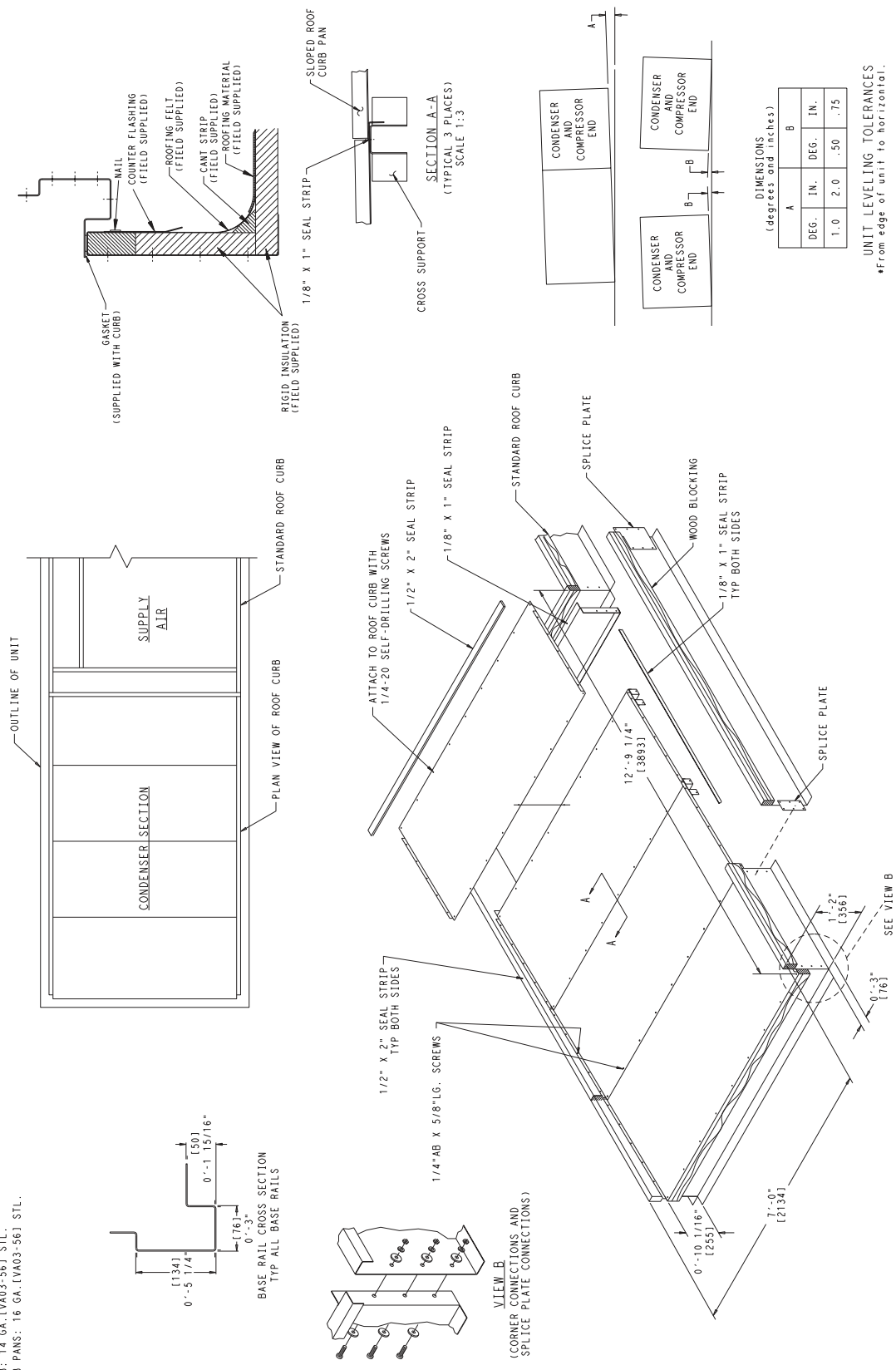

DIMENSIONS
(degrees and inches)

A	B
DEG. IN.	DEG. IN.
1.0	2.0
	.50
	.75

UNIT LEVELING TOLERANCES
#From edge of unit to horizontal.

Selection procedure



I Determine cooling and heating loads at design conditions.

Given:

Required Gross Cooling Capacity (TC) 950,000 Btuh
 Sensible Gross Heat Capacity (SHC) . . 775,000 Btuh
 Required Heating Capacity 500,000 Btuh
 Condenser Entering-Air Temperature db 95 F
 Indoor Air Temperature 82 F edb, 67 F ewb
 Evaporator Air Quantity 31,500 Cfm
 External Static Pressure 3.0 in. wg
 Electrical Characteristics (V-Ph-Hz) 460-3-60

Integrated economizer required.

Options: VFD on supply fan, 65% filters, premium efficiency motor, integrated economizer, power exhaust, airfoil fan, vertical duct configuration.

II Select the rooftop unit based on required cooling capacity.

Enter cooling capacity table on page 103 for size 090 (standard capacity coil) at condenser entering temperature 95 F, evaporator air quantity of 31,500 cfm, and an indoor wet bulb temperature of 67 F.

The unit will provide a total gross cooling capacity of 1,011,000 Btuh and an SHC of 750,000 Btuh.

Since these values were not at 80 F edb, calculate an SHC correction (at 82 F edb) based on the notes following the Cooling Capacity tables. Calculate a corrected SHC of 812,400 Btuh.

Unit meets design conditions for TC and SHC.

NOTE: Unit ratings are gross capacities and do not include the effect of supply-fan motor heat. To calculate net capacities see Step V.

III Select net heating capacity of unit to meet design condition requirements.

Enter the Gas Heating Capacities table on page 7. The 48P2090 unit (low heat) will provide 520,000 Btuh of heating with an input of 650,000 Btuh.

IV Determine fan speed and power requirements at design conditions.

Before entering the Fan Performance tables, calculate the selection static pressure required based on unit

components. Tabulated fan performance includes 2-in. filters and wet evaporator coils. From the given and the Component Pressure Drops table on page 138 find:

Design external static pressure	3.00 in. wg
Low Gas Heat	0.70 in. wg
Economizer	0.28 in. wg
65% Filters	0.22 in. wg
Modulating PE	0.25 in. wg
Total Selection Static Pressure	4.45 in. wg

Enter the Fan Performance table on page 132 for 48P2090 with airfoil fan at 4.45 in. wg at 31,500 cfm. The 50 Hp motor will provide the required ESP at 1548 rpm and 44.53 Bhp.

V Determine net capacities (if required).

Cooling capacities are gross capacities and do not include supply-fan motor (IFM) heat.

Use the Bhp determined in Step IV to find IFM watts:

$$\begin{aligned} \text{Watts} &= \text{Bhp} \times 746 / (\text{Motor Efficiency} / 100) \\ &= 44.53 \times 746 / (94.5 / 100) \\ &= 35,153 \end{aligned}$$

Convert Watts to Btuh:

$$\begin{aligned} \text{Btuh} &= \text{Watts} \times 3.412 \text{ Btuh/Watt} \\ &= 35,153 \times 3.412 \\ &= 119,941 \text{ Btuh (IFM Heat)} \end{aligned}$$

Net Capacity = Gross Capacity – IFM Heat

$$\begin{aligned} &= 1,011,000 - 119,941 \\ &= 891,059 \text{ Btuh} \end{aligned}$$

Net Sensible Capacity = Gross SHC – IFM Heat

$$\begin{aligned} &= 812,400 - 119,941 \\ &= 692,459 \text{ Btuh} \end{aligned}$$

VI Select the unit that corresponds to power source available.

The model number nomenclature on page 6 shows that the 460-3-60 unit is available.

COOLING CAPACITIES

48/50P2,P3,P4,P5030 (30 TON) STANDARD CAPACITY COIL — STANDARD MODE

Temp (F) Air Entering Condenser (Edb)		Evaporator Air Quantity — Cfm																			
		6,000					7,500					9,000					10,500				
		Evaporator Air — Ewb (F)																			
		75	72	67	62	57	75	72	67	62	57	75	72	67	62	57	75	72	67	62	57
75	TC	378	362	334	308	282	399	379	351	325	297	412	392	363	336	312	421	401	372	345	327
	SHC	155	167	204	236	265	159	183	224	262	292	166	195	241	285	312	175	206	256	307	327
	KW	22.5	22.1	21.3	20.8	20.5	22.5	21.7	21.2	20.7	20.7	23.4	22.8	22.1	21.4	21.0	23.6	23.1	22.3	21.6	21.3
	BF	0.00	0.00	0.22	0.16	0.14	0.00	0.00	0.19	0.16	0.19	0.00	0.27	0.20	0.18	0.26	0.00	0.25	0.21	0.19	0.33
85	TC	367	353	326	300	273	384	369	342	316	290	396	380	353	327	305	404	389	361	335	319
	SHC	150	165	201	231	259	155	180	220	257	281	162	191	236	281	305	170	202	252	303	319
	KW	24.7	24.4	23.7	23.4	23.2	25.2	24.8	24.1	23.7	23.1	25.6	25.1	24.4	23.9	23.6	25.8	25.3	24.7	24.1	23.8
	BF	0.00	0.00	0.21	0.15	0.14	0.00	0.16	0.18	0.16	0.23	0.00	0.25	0.20	0.18	0.27	0.36	0.24	0.21	0.19	0.35
95	TC	357	343	316	289	264	373	357	331	304	281	383	368	341	315	295	391	376	349	322	309
	SHC	146	162	196	226	253	150	176	215	252	272	159	187	232	275	295	166	198	248	296	309
	KW	27.4	27.1	26.6	26.4	26.1	27.9	27.5	27.0	26.6	26.1	28.2	27.8	27.3	26.9	26.6	28.4	28.0	27.5	27.1	26.8
	BF	0.00	0.00	0.19	0.15	0.14	0.00	0.28	0.18	0.16	0.26	0.00	0.24	0.19	0.17	0.30	0.31	0.23	0.21	0.20	0.37
105	TC	344	330	304	277	251	360	344	318	291	268	369	354	327	301	284	377	361	334	308	297
	SHC	141	158	191	220	244	145	171	210	246	268	154	182	226	269	284	162	193	242	288	297
	KW	30.5	30.3	30.0	29.8	30.2	31.0	30.7	30.3	30.0	29.9	31.2	31.0	30.6	30.2	30.1	31.5	31.2	30.7	30.5	30.2
	BF	0.00	0.00	0.17	0.14	0.16	0.00	0.25	0.17	0.15	0.23	0.18	0.22	0.19	0.17	0.32	0.28	0.22	0.20	0.20	0.39
115	TC	330	315	289	263	237	344	328	302	276	256	352	337	310	285	272	360	344	317	291	285
	SHC	135	153	185	214	234	141	166	203	239	256	149	177	219	261	272	156	187	235	279	285
	KW	34.0	33.9	33.9	34.2	34.6	34.4	34.3	34.1	34.3	34.6	34.7	34.6	34.3	34.4	34.5	35.1	34.8	34.4	34.5	34.4
	BF	0.00	0.00	0.16	0.14	0.18	0.00	0.22	0.17	0.15	0.27	0.29	0.21	0.18	0.17	0.35	0.26	0.21	0.20	0.21	0.42

48/50P2,P3,P4,P5030 (30 TON) STANDARD CAPACITY COIL — STANDARD MODE (cont)

Temp (F) Air Entering Condenser (Edb)		Evaporator Air Quantity — Cfm														
		12,000					13,500					15,000				
		Evaporator Air — Ewb (F)														
		75	72	67	62	57	75	72	67	62	57	75	72	67	62	57
75	TC	428	408	378	352	339	434	414	383	357	349	439	418	388	360	357
	SHC	182	216	272	326	339	189	226	286	341	349	195	235	300	354	357
	KW	23.8	23.3	22.5	21.8	21.5	24.0	23.4	22.6	21.9	21.8	24.1	23.6	22.7	22.0	22.0
	BF	0.33	0.25	0.22	0.22	0.39	0.31	0.25	0.24	0.25	0.45	0.30	0.26	0.25	0.28	0.49
85	TC	411	395	368	341	330	417	400	373	346	340	422	404	376	349	348
	SHC	177	212	268	321	330	183	221	282	334	340	190	230	296	348	348
	KW	26.0	25.5	24.8	24.3	24.0	26.2	25.7	25.0	24.4	24.2	26.3	25.8	25.1	24.4	24.4
	BF	0.30	0.24	0.22	0.22	0.41	0.29	0.25	0.23	0.26	0.46	0.29	0.25	0.25	0.29	0.50
95	TC	398	382	355	328	320	404	387	359	332	330	408	391	363	339	338
	SHC	173	207	263	313	320	179	217	277	327	330	185	226	291	334	338
	KW	28.6	28.2	27.6	27.2	27.0	28.8	28.3	27.7	27.3	27.2	28.9	28.5	27.8	27.3	27.3
	BF	0.29	0.23	0.22	0.23	0.43	0.28	0.24	0.23	0.26	0.48	0.28	0.25	0.24	0.32	0.52
105	TC	383	367	340	313	308	388	371	344	320	317	392	375	347	326	325
	SHC	168	202	257	303	308	175	212	271	309	317	180	221	285	321	325
	KW	31.7	31.4	30.9	30.5	30.4	31.9	31.5	31.0	30.4	30.6	32.0	31.6	31.0	30.7	30.7
	BF	0.27	0.23	0.22	0.24	0.45	0.26	0.24	0.23	0.32	0.50	0.27	0.25	0.24	0.35	0.54
115	TC	365	349	322	296	295	369	353	326	303	303	372	356	329	311	310
	SHC	163	196	250	292	295	169	206	264	303	303	175	214	278	310	310
	KW	35.3	35.0	34.5	34.4	34.5	35.4	35.1	34.6	34.5	34.5	35.5	35.2	34.6	34.5	34.5
	BF	0.25	0.22	0.21	0.26	0.47	0.25	0.23	0.23	0.31	0.52	0.26	0.25	0.24	0.36	0.56

LEGEND

48/50P3,P5 units only.

BF — Bypass Factor **KW** — Compressor Motor Power Input
Edb — Entering Dry Bulb **SHC** — Sensible Heat Cap. (1000 Btu/h)
Ewb — Entering Wet Bulb **TC** — Total Cap. (1000 Btu/h) Gross

NOTES:

- Direct interpolation is permissible. Do not extrapolate.
- The following formulas may be used:

$$t_{db} = t_{edb} - \frac{\text{sensible capacity (Btu/h)}}{1.10 \times \text{cfm}}$$

$$t_{wb} = \text{Wet-bulb temperature corresponding to enthalpy of air leaving evaporator coil } (h_{wb}).$$

$$h_{wb} = h_{ewb} - \frac{\text{total capacity (Btu/h)}}{4.5 \times \text{cfm}}$$

Where: h_{ewb} = Enthalpy of air entering evaporator coil.

- SHC is based on 80 F edb temperature of air entering evaporator coil.

Below 80 F edb, subtract (corr factor x cfm) from SHC.
 Above 80 F edb, add (corr factor x cfm) to SHC.

BF	ENTERING AIR DRY-BULB TEMP (F)					
	79	78	77	76	75	under 75
	81	82	83	84	85	over 85
Correction Factor						
.05	1.04	2.09	3.14	4.18	5.22	Use formula shown below
.10	0.99	1.98	2.97	3.96	4.95	
.20	0.88	1.76	2.64	3.52	4.40	

Interpolation is permissible.
 Correction Factor = $1.10 \times (1 - \text{BF}) \times (\text{edb} - 80)$.

- Cooling capacities are gross and do not include deduction for indoor fan motor heat.

COOLING CAPACITIES (cont)

48/50P2,P3,P4,P5030 (30 TON) STANDARD CAPACITY COIL — SUBCOOLING MODE

Temp (F) Air Entering Condenser (Edb)		Evaporator Air Quantity — Cfm																			
		6,000					7,500					9,000					10,500				
		Evaporator Air — Ewb (F)																			
		75	72	67	62	57	75	72	67	62	57	75	72	67	62	57	75	72	67	62	57
75	TC	341	322	293	266	243	361	340	309	282	260	375	353	321	293	273	385	363	330	301	283
	SHC	97	118	151	185	218	104	128	168	209	244	112	138	184	231	266	118	149	200	252	283
	kW	23.7	23.2	22.4	21.8	21.3	24.3	23.7	22.9	22.2	21.6	24.8	24.2	23.2	22.5	21.9	25.1	24.5	23.5	22.7	22.2
85	BF	0.00	0.03	0.07	0.08	0.09	0.03	0.07	0.09	0.10	0.15	0.05	0.10	0.12	0.12	0.21	0.10	0.13	0.14	0.15	0.26
	TC	320	301	274	249	227	335	316	288	262	244	346	327	298	271	256	355	335	305	279	264
	SHC	78	100	135	170	205	83	108	150	192	229	89	117	164	213	249	94	125	179	232	264
95	kW	25.8	25.3	24.5	24.0	23.5	26.4	25.8	25.0	24.3	23.8	26.8	26.2	25.3	24.6	24.1	27.1	26.5	25.6	24.8	24.3
	BF	0.00	0.03	0.07	0.08	0.10	0.03	0.07	0.09	0.10	0.16	0.06	0.10	0.12	0.12	0.22	0.10	0.13	0.14	0.15	0.28
	TC	297	280	254	231	212	310	293	266	242	227	319	301	274	250	238	326	308	280	257	245
105	SHC	60	82	119	155	193	62	88	131	175	213	66	95	144	195	231	70	102	158	213	245
	kW	28.2	27.7	27.0	26.5	26.0	28.7	28.1	27.4	26.3	25.9	29.1	28.5	27.6	27.0	26.6	29.4	28.7	27.9	27.1	26.8
	BF	0.00	0.04	0.07	0.08	0.10	0.03	0.07	0.09	0.10	0.17	0.06	0.10	0.12	0.12	0.23	0.10	0.13	0.14	0.15	0.29
115	TC	274	258	234	212	198	284	268	244	222	211	291	275	250	229	220	296	280	254	234	225
	SHC	42	65	102	140	179	42	68	113	158	197	43	73	125	177	214	46	80	137	194	225
	kW	30.9	30.4	29.8	29.2	28.8	31.3	30.8	30.1	29.5	29.1	31.6	31.0	30.3	29.7	29.3	31.8	31.3	30.4	29.8	29.5
115	BF	0.00	0.04	0.07	0.08	0.13	0.04	0.07	0.09	0.10	0.18	0.06	0.10	0.12	0.13	0.24	0.10	0.13	0.14	0.16	0.30
	TC	250	236	214	194	183	257	243	221	201	194	262	247	225	207	201	266	251	228	213	205
	SHC	23	47	86	125	164	21	49	95	142	181	20	52	105	159	196	21	56	116	176	205
115	kW	33.9	33.4	32.8	32.3	32.1	34.2	33.7	33.0	32.5	32.2	34.4	33.9	33.2	32.7	32.4	34.6	34.0	33.3	32.8	32.6
	BF	0.01	0.04	0.07	0.08	0.14	0.04	0.08	0.10	0.10	0.20	0.07	0.11	0.12	0.13	0.25	0.10	0.13	0.14	0.17	0.32

48/50P2,P3,P4,P5030 (30 TON) STANDARD CAPACITY COIL — SUBCOOLING MODE (cont)

Temp (F) Air Entering Condenser (Edb)		Evaporator Air Quantity — Cfm														
		12,000					13,500					15,000				
		Evaporator Air — Ewb (F)														
		75	72	67	62	57	75	72	67	62	57	75	72	67	62	57
75	TC	395	372	337	308	294	401	378	343	314	304	309	411	385	348	319
	SHC	127	159	216	271	294	132	169	231	287	304	309	442	412	348	299
	kW	25.5	24.8	23.8	22.9	22.5	25.7	25.0	24.0	23.1	22.8	22.9	26.1	25.2	24.1	23.2
85	BF	0.12	0.15	0.15	0.18	0.33	0.15	0.16	0.17	0.21	0.39	0.40	0.17	0.18	0.19	0.25
	TC	363	342	311	274	285	368	348	316	290	282	374	352	321	296	290
	SHC	100	134	193	274	255	105	143	208	263	282	112	152	222	276	290
95	kW	27.4	26.7	25.8	24.6	24.9	27.6	27.0	26.0	25.1	24.9	27.9	27.1	26.1	25.3	25.1
	BF	0.13	0.15	0.15	0.34	0.19	0.15	0.17	0.17	0.22	0.40	0.17	0.18	0.19	0.26	0.45
	TC	331	313	285	262	253	336	318	289	268	261	340	321	292	272	267
105	SHC	74	110	171	230	253	79	119	185	241	261	84	126	198	253	267
	kW	29.6	29.0	28.0	27.3	27.0	29.8	29.2	28.2	27.5	27.2	30.0	29.3	28.3	27.6	27.5
	BF	0.13	0.15	0.16	0.21	0.37	0.15	0.17	0.17	0.24	0.42	0.17	0.18	0.19	0.28	0.46
115	TC	301	284	258	241	233	304	287	261	245	239	307	289	263	249	244
	SHC	49	86	149	208	233	53	93	161	219	239	57	100	174	230	244
	kW	32.0	31.4	30.6	30.0	29.7	32.2	31.6	30.7	30.1	29.9	32.4	31.7	30.8	30.2	30.1
115	BF	0.13	0.15	0.16	0.21	0.37	0.15	0.17	0.17	0.24	0.42	0.17	0.18	0.19	0.28	0.46
	TC	268	253	231	218	211	271	255	233	222	216	273	257	234	224	221
	SHC	24	62	127	186	211	26	68	139	197	216	29	74	150	207	221
115	kW	34.7	34.1	33.4	32.9	32.7	34.8	34.3	33.5	33.0	32.9	34.9	34.3	33.6	33.1	33.0
	BF	0.13	0.15	0.16	0.22	0.38	0.15	0.17	0.17	0.26	0.43	0.17	0.19	0.19	0.29	0.48

LEGEND

48/50P3,P5 units only.

BF — Bypass Factor **kW** — Compressor Motor Power Input
Edb — Entering Dry Bulb **SHC** — Sensible Heat Cap. (1000 Btu/h)
Ewb — Entering Wet Bulb **TC** — Total Cap. (1000 Btu/h) Gross

NOTES:

- The SHC is based on 80 F edb temperature of air entering evaporator coil. For edb temperatures other than 80 F, adjust SHC by multiplying the correction factor and the cfm and then adding or subtracting the value from the SHC.

- Interpolation is permissible.
- Correction Factor = $1.10 \times (1 - BF) \times (edb - 80)$.
- Cooling capacities are gross and do not include deduction for indoor fan motor heat.
- SHC values provided are in subcooling mode with the gas bypass valve closed and reflect the maximum SHC in subcooling mode. The P Series innovative modulating valve system can reduce SHC as needed to meet the supply air set point requirement with minimal change in latent capacity. This will provide variable SHC to meet the space load.

Performance data (cont)



COOLING CAPACITIES (cont)

48/50P2,P3,P4,P5030 (30 TON) STANDARD CAPACITY COIL — HOT GAS REHEAT MODE

Temp (F) Air Ent Condenser (Edb)		Air Entering Evaporator — Ewb (F)													
		75 Dry Bulb 62.5 Wet Bulb (50% RH)							75 Dry Bulb 65.3 Wet Bulb (60% RH)						
		Air Entering Evaporator — Cfm													
		6000	7500	9000	10,500	12,000	13,500	15,000	6000	7500	9000	10,500	12,000	13,500	15,000
80	TC	115	123	128	132	135	137	139	121	129	135	138	141	143	145
	SHC	1	9	19	29	40	50	61	-25	-21	-16	-10	-3	5	12
	kW	23.1	23.0	23.1	23.1	23.2	23.3	23.3	23.6	23.6	23.6	23.7	23.7	23.8	23.9
	BF	0.07	0.10	0.12	0.14	0.16	0.17	0.19	0.06	0.09	0.11	0.13	0.15	0.17	0.19
75	TC	117	126	131	135	138	140	142	124	132	137	141	144	146	148
	SHC	3	11	21	31	41	52	63	-24	-20	-14	-8	-1	6	14
	kW	22.4	22.3	22.4	22.5	22.5	22.6	22.7	23.0	22.9	23.0	23.1	23.2	23.2	23.3
	BF	0.07	0.10	0.12	0.14	0.16	0.17	0.19	0.06	0.09	0.11	0.13	0.15	0.17	0.19
70	TC	120	128	134	138	141	143	145	126	134	140	144	147	149	151
	SHC	4	13	22	32	43	53	64	-23	-18	-13	-7	-0	7	15
	kW	21.7	21.7	21.8	21.9	22.0	22.1	22.1	22.3	22.3	22.4	22.5	22.6	22.7	22.8
	BF	0.07	0.10	0.12	0.14	0.16	0.17	0.19	0.06	0.09	0.11	0.13	0.15	0.17	0.19
60	TC	119	126	131	135	137	139	141	124	132	137	140	143	145	146
	SHC	4	12	21	31	41	52	63	-23	-19	-14	-8	-1	6	14
	kW	22.3	22.4	22.6	22.7	22.8	22.9	23.0	23.0	23.2	23.3	23.4	23.5	23.6	23.7
	BF	0.07	0.10	0.12	0.14	0.16	0.17	0.19	0.06	0.09	0.11	0.13	0.15	0.17	0.19
50	TC	123	131	136	140	142	144	146	129	136	142	145	148	150	152
	SHC	6	15	24	34	44	55	65	-21	-17	-12	-5	2	9	17
	kW	21.1	21.3	21.4	21.6	21.7	21.9	22.0	21.9	22.0	22.2	22.3	22.4	22.6	22.7
	BF	0.07	0.10	0.12	0.14	0.16	0.17	0.19	0.06	0.09	0.11	0.13	0.15	0.17	0.19
40	TC	127	135	140	144	147	150	152	132	141	146	151	154	157	159
	SHC	9	17	26	36	47	57	68	-18	-15	-9	-3	5	12	20
	kW	20.1	20.3	20.5	20.7	20.8	20.9	21.0	20.9	21.1	21.2	21.4	21.5	21.7	21.8
	BF	0.07	0.10	0.12	0.14	0.15	0.17	0.19	0.06	0.09	0.11	0.13	0.15	0.17	0.19

48/50P2,P3,P4,P5030 (30 TON) STANDARD CAPACITY COIL — HOT GAS REHEAT MODE (cont)

Temp (F) Air Ent Condenser (Edb)		Air Entering Evaporator — Ewb (F)													
		75 Dry Bulb 68 Wet Bulb (70% RH)							75 Dry Bulb 70.5 Wet Bulb (80% RH)						
		Air Entering Evaporator — Cfm													
		6000	7500	9000	10,500	12,000	13,500	15,000	6000	7500	9000	10,500	12,000	13,500	15,000
80	TC	127	135	141	144	147	149	151	133	141	146	150	152	155	157
	SHC	-52	-52	-50	-48	-44	-40	-36	-77	-81	-83	-83	-83	-82	-80
	kW	24.3	24.2	24.2	24.3	24.4	24.5	24.5	24.9	24.9	24.9	25.0	25.0	25.1	25.1
	BF	0.03	0.07	0.10	0.13	0.15	0.17	0.18	0.00	0.02	0.05	0.10	0.12	0.15	0.17
75	TC	130	138	143	147	150	152	154	135	143	149	153	156	159	161
	SHC	-50	-50	-49	-46	-43	-39	-34	-76	-80	-81	-82	-81	-80	-78
	kW	23.6	23.6	23.7	23.7	23.8	23.9	24.0	24.3	24.3	24.3	24.4	24.5	24.5	24.6
	BF	0.03	0.07	0.10	0.13	0.15	0.17	0.18	0.00	0.02	0.05	0.09	0.12	0.15	0.17
70	TC	132	140	146	150	153	156	158	137	146	152	156	160	163	165
	SHC	-49	-49	-48	-45	-41	-37	-32	-75	-78	-80	-80	-79	-78	-76
	kW	23.0	23.0	23.1	23.2	23.3	23.4	23.4	23.8	23.7	23.8	23.8	23.9	24.0	24.1
	BF	0.03	0.07	0.10	0.12	0.15	0.16	0.18	0.00	0.01	0.05	0.09	0.12	0.15	0.17
60	TC	130	137	142	146	148	150	152	135	142	147	151	154	156	157
	SHC	-50	-50	-49	-46	-42	-38	-34	-76	-79	-81	-81	-81	-80	-78
	kW	23.8	23.9	24.0	24.1	24.3	24.4	24.4	24.6	24.7	24.8	24.9	25.0	25.0	25.1
	BF	0.03	0.07	0.10	0.13	0.15	0.17	0.18	0.00	0.02	0.05	0.10	0.13	0.15	0.17
50	TC	134	142	147	151	154	157	159	139	147	153	157	160	163	165
	SHC	-47	-48	-46	-43	-40	-35	-30	-73	-77	-78	-78	-77	-76	-74
	kW	22.7	22.8	22.9	23.1	23.2	23.3	23.4	23.5	23.5	23.7	23.8	23.9	24.0	24.1
	BF	0.02	0.07	0.10	0.13	0.15	0.16	0.18	0.00	0.01	0.05	0.09	0.12	0.15	0.17
40	TC	138	147	153	158	161	164	166	144	153	159	164	168	171	173
	SHC	-45	-45	-43	-40	-36	-31	-27	-71	-74	-75	-75	-74	-72	-70
	kW	21.7	21.8	22.0	22.1	22.3	22.4	22.5	22.5	22.6	22.7	22.9	23.0	23.1	23.2
	BF	0.02	0.07	0.10	0.12	0.15	0.16	0.18	0.00	0.01	0.05	0.09	0.12	0.15	0.17

LEGEND

BF — Bypass Factor
Edb — Entering Dry Bulb
Ewb — Entering Wet Bulb
kW — Compressor Motor Power Input
RH — Relative Humidity
SHC — Sensible Heat Cap. (1000 Btu/h)
TC — Total Cap. (1000 Btu/h) Gross

6. SHC values provided reflect maximum reheat values with 100% gas bypass. Negative SHC value indicates that the air entering the coil is being heated at 100% gas bypass. The P Series innovative modulating valve system will reduce the gas bypass as required to meet the supply air setpoint with minimal change in latent capacity. The space will NOT be overheated and the unit will provide variable SHC to meet the space load.

NOTES:

- The SHC is based on 75 F edb temperature of air entering evaporator coil. For edb temperatures other than 75 F, adjust SHC by multiplying the correction factor and the cfm and then adding or subtracting the value from the SHC.
- Interpolation is permissible.
- Correction Factor = $1.10 \times (1 - BF) \times (edb - 75)$.
- Cooling capacities are gross and do not include deduction for indoor fan motor heat.
- Capacity table includes impact of outdoor fan staging at temperatures below 75 F.

COOLING CAPACITIES (cont)

48/50P2,P3,P4,P5030 (30 TON) HIGH-CAPACITY COIL — STANDARD MODE

Temp (F) Air Entering Condenser (Edb)		Evaporator Air Quantity — Cfm																			
		6,000					7,500					9,000					10,500				
		Evaporator Air — Ewb (F)																			
		75	72	67	62	57	75	72	67	62	57	75	72	67	62	57	75	72	67	62	57
75	TC	384	367	338	312	289	405	386	356	329	307	418	400	369	341	323	429	410	378	351	338
	SHC	158	177	211	245	277	164	192	233	274	300	175	205	253	300	323	183	217	271	325	338
	KW	22.8	22.3	21.5	20.8	20.3	23.3	22.8	21.9	21.2	20.6	23.7	23.1	22.3	21.5	21.1	23.9	23.4	22.5	21.8	21.5
	BF	0.00	0.00	0.10	0.07	0.07	0.00	0.16	0.09	0.08	0.17	0.13	0.14	0.11	0.09	0.23	0.20	0.14	0.12	0.11	0.31
85	TC	373	356	330	305	282	392	373	346	322	299	404	386	358	333	317	414	395	367	342	331
	SHC	153	172	208	241	272	161	187	229	270	299	170	200	248	296	317	179	212	267	321	331
	KW	25.0	24.5	23.7	23.2	22.9	25.5	25.0	24.2	23.6	23.1	25.9	25.3	24.5	23.9	23.5	26.1	25.6	24.8	24.1	23.9
	BF	0.00	0.00	0.09	0.07	0.07	0.00	0.14	0.09	0.08	0.15	0.22	0.13	0.10	0.09	0.24	0.18	0.13	0.11	0.11	0.32
95	TC	360	346	322	297	272	377	362	337	312	291	389	374	348	323	309	399	383	356	331	323
	SHC	148	169	204	237	266	156	183	225	266	291	165	196	244	292	309	174	208	263	315	323
	KW	27.5	27.1	26.5	26.1	26.0	28.0	27.6	26.9	26.5	26.2	28.4	27.9	27.2	26.7	26.5	28.7	28.2	27.5	27.0	26.8
	BF	0.00	0.10	0.09	0.07	0.07	0.00	0.13	0.09	0.08	0.17	0.19	0.12	0.10	0.09	0.26	0.16	0.13	0.11	0.12	0.34
105	TC	350	336	311	285	260	365	351	326	300	281	377	362	336	310	298	386	370	343	317	312
	SHC	144	165	199	231	257	152	179	220	260	281	161	191	239	285	298	170	203	257	307	312
	KW	30.5	30.2	29.8	29.6	29.9	31.0	30.7	30.2	29.9	29.8	31.4	31.0	30.5	30.3	30.0	31.7	31.3	30.7	30.5	30.3
	BF	0.00	0.17	0.08	0.06	0.09	0.13	0.12	0.09	0.07	0.20	0.17	0.12	0.10	0.09	0.29	0.15	0.12	0.11	0.12	0.36
115	TC	338	323	297	272	247	351	337	310	285	269	362	346	320	294	285	370	353	326	302	299
	SHC	138	160	193	225	246	148	173	214	253	269	156	186	233	278	285	164	197	251	295	299
	KW	34.1	33.9	33.7	33.9	34.8	34.5	34.4	34.1	34.1	34.5	35.0	34.7	34.3	34.5	34.4	35.3	35.0	34.5	34.5	34.5
	BF	0.00	0.14	0.07	0.06	0.12	0.20	0.11	0.08	0.07	0.23	0.15	0.11	0.10	0.10	0.32	0.14	0.12	0.11	0.15	0.39

48/50P2,P3,P4,P5030 (30 TON) HIGH-CAPACITY COIL — STANDARD MODE (cont)

Temp (F) Air Entering Condenser (Edb)		Evaporator Air Quantity — Cfm														
		12,000					13,500					15,000				
		Evaporator Air — Ewb (F)														
		75	72	67	62	57	75	72	67	62	57	75	72	67	62	57
75	TC	437	417	385	356	350	444	423	391	361	360	449	428	396	370	369
	SHC	191	229	289	343	350	199	240	306	358	360	206	250	323	370	369
	KW	24.2	23.6	22.7	21.9	21.8	24.3	23.8	22.9	22.1	22.1	24.5	23.9	23.0	22.3	22.3
	BF	0.18	0.14	0.13	0.14	0.37	0.18	0.15	0.14	0.19	0.43	0.18	0.15	0.15	0.24	0.47
85	TC	421	402	373	348	343	427	407	378	353	353	432	412	382	362	361
	SHC	186	223	284	338	343	193	234	301	351	353	200	245	318	362	361
	KW	26.4	25.8	25.0	24.3	24.2	26.5	26.0	25.1	24.4	24.4	26.6	26.1	25.2	24.7	24.7
	BF	0.17	0.14	0.12	0.15	0.39	0.17	0.14	0.14	0.20	0.44	0.17	0.15	0.15	0.26	0.48
95	TC	406	389	362	337	334	411	395	367	344	344	416	399	370	352	352
	SHC	181	219	280	331	334	188	230	297	344	344	195	240	313	352	352
	KW	28.9	28.4	27.7	27.1	27.0	29.0	28.6	27.8	27.3	27.3	29.2	28.7	27.9	27.5	27.5
	BF	0.16	0.13	0.12	0.16	0.40	0.16	0.14	0.13	0.22	0.45	0.17	0.16	0.14	0.28	0.50
105	TC	392	376	348	324	323	397	380	353	333	332	402	384	356	340	340
	SHC	177	214	275	321	323	184	225	292	329	332	191	235	308	340	340
	KW	31.9	31.5	30.9	30.4	30.5	32.1	31.7	31.0	30.6	30.7	32.3	31.8	31.2	30.9	30.9
	BF	0.15	0.13	0.12	0.18	0.42	0.16	0.14	0.13	0.26	0.47	0.16	0.16	0.15	0.30	0.51
115	TC	375	359	331	311	309	380	363	335	318	318	384	366	338	325	325
	SHC	172	209	268	304	309	179	219	285	318	318	185	229	301	325	325
	KW	35.5	35.2	34.6	34.3	34.5	35.7	35.3	34.8	34.7	34.6	35.9	35.5	34.9	34.8	34.7
	BF	0.15	0.13	0.12	0.23	0.45	0.15	0.14	0.13	0.27	0.49	0.16	0.15	0.15	0.33	0.53

LEGEND

48/50P3,P5 units only.

BF — Bypass Factor **KW** — Compressor Motor Power Input
Edb — Entering Dry Bulb **SHC** — Sensible Heat Cap. (1000 Btuh)
Ewb — Entering Wet Bulb **TC** — Total Cap. (1000 Btuh) Gross

NOTES:

- Direct interpolation is permissible. Do not extrapolate.
- The following formulas may be used:

$$t_{db} = t_{edb} - \frac{\text{sensible capacity (Btuh)}}{1.10 \times \text{cfm}}$$

t_{wb} = Wet-bulb temperature corresponding to enthalpy of air leaving evaporator coil (h_{wb}).

$$h_{wb} = h_{ewb} - \frac{\text{total capacity (Btuh)}}{4.5 \times \text{cfm}}$$

Where: h_{ewb} = Enthalpy of air entering evaporator coil.

- SHC is based on 80 F edb temperature of air entering evaporator coil.

Below 80 F edb, subtract (corr factor x cfm) from SHC.
 Above 80 F edb, add (corr factor x cfm) to SHC.

BF	ENTERING AIR DRY-BULB TEMP (F)					
	79	78	77	76	75	under 75
	81	82	83	84	85	over 85
Correction Factor						
.05	1.04	2.09	3.14	4.18	5.22	Use formula shown below
.10	0.99	1.98	2.97	3.96	4.95	
.20	0.88	1.76	2.64	3.52	4.40	

Interpolation is permissible.
 Correction Factor = $1.10 \times (1 - BF) \times (edb - 80)$.

- Cooling capacities are gross and do not include deduction for indoor fan motor heat.

Performance data (cont)



COOLING CAPACITIES (cont)

48/50P2,P3,P4,P5030 (30 TON) HIGH-CAPACITY COIL — SUBCOOL MODE

Temp (F) Air Entering Condenser (Edb)		Evaporator Air Quantity — Cfm																			
		6,000					7,500					9,000					10,500				
		Evaporator Air — Ewb (F)																			
		75	72	67	62	57	75	72	67	62	57	75	72	67	62	57	75	72	67	62	57
75	TC	353	332	300	272	249	374	351	318	288	268	389	365	330	300	282	398	377	340	309	292
	SHC	98	119	153	188	225	106	131	171	214	252	114	142	190	239	121	155	208	262	292	
	kW	24.1	23.5	22.6	22.0	21.4	24.8	24.1	23.2	22.4	21.8	25.3	24.6	23.6	22.7	22.2	25.6	25.0	23.9	23.0	
	BF	0.00	0.01	0.03	0.03	0.05	0.01	0.03	0.04	0.05	0.11	0.02	0.04	0.05	0.06	0.16	0.04	0.06	0.07	0.08	
85	TC	329	310	280	254	233	346	326	294	267	251	359	337	305	277	263	369	346	313	285	
	SHC	78	100	136	172	211	83	109	151	196	236	90	119	168	219	257	97	129	185	241	
	kW	26.2	25.6	24.8	24.2	23.7	26.8	26.2	25.2	24.5	24.0	27.3	26.6	25.6	24.8	24.3	27.6	26.9	25.9	25.0	
	BF	0.00	0.01	0.03	0.03	0.05	0.01	0.03	0.04	0.05	0.12	0.02	0.04	0.05	0.06	0.17	0.04	0.06	0.07	0.09	
95	TC	306	287	259	234	219	319	300	271	246	234	329	309	279	254	244	337	317	286	261	
	SHC	59	81	118	155	198	61	87	131	177	219	65	95	146	199	238	70	104	162	220	
	kW	28.6	28.0	27.3	26.7	26.3	29.1	28.5	27.6	27.0	26.6	29.5	28.8	27.9	27.2	26.8	29.8	29.1	28.1	27.4	
	BF	0.00	0.01	0.03	0.03	0.07	0.01	0.03	0.04	0.05	0.13	0.02	0.04	0.05	0.07	0.18	0.04	0.06	0.07	0.09	
105	TC	281	264	238	215	204	291	273	247	224	216	299	280	253	231	225	305	286	257	239	
	SHC	39	62	101	140	183	38	65	112	160	202	40	71	124	180	219	44	79	138	200	
	kW	31.2	30.7	30.1	29.5	29.2	31.7	31.1	30.3	29.7	29.4	32.0	31.4	30.5	29.9	29.6	32.3	31.6	30.7	30.1	
	BF	0.00	0.01	0.03	0.03	0.09	0.01	0.03	0.04	0.05	0.14	0.03	0.05	0.06	0.07	0.19	0.04	0.06	0.07	0.11	
115	TC	256	240	216	195	188	263	246	222	202	198	267	251	226	208	205	271	254	229	216	
	SHC	19	43	84	124	168	15	44	92	142	185	15	47	103	162	200	17	53	115	177	
	kW	34.2	33.8	33.2	32.9	32.8	34.5	34.0	33.3	32.9	32.7	34.7	34.2	33.4	32.9	32.8	34.9	34.3	33.6	33.1	
	BF	0.00	0.02	0.03	0.03	0.10	0.01	0.03	0.04	0.05	0.16	0.03	0.05	0.06	0.08	0.21	0.04	0.06	0.07	0.13	

48/50P2,P3,P4,P5030 (30 TON) HIGH-CAPACITY COIL — SUBCOOL MODE (cont)

Temp (F) Air Entering Condenser (Edb)		Evaporator Air Quantity — Cfm														
		12,000					13,500					15,000				
		Evaporator Air — Ewb (F)														
		75	72	67	62	57	75	72	67	62	57	75	72	67	62	57
75	TC	396	386	348	316	305	405	388	355	324	316	409	401	361	331	326
	SHC	123	167	226	282	305	130	174	245	298	316	132	192	263	314	326
	kW	25.5	25.3	24.2	23.2	22.9	25.6	25.4	24.4	23.4	23.2	25.8	25.8	24.6	23.7	23.5
	BF	0.06	0.07	0.08	0.12	0.30	0.07	0.09	0.09	0.16	0.36	0.09	0.10	0.11	0.19	0.41
85	TC	375	354	319	293	282	383	359	325	300	292	389	365	329	306	300
	SHC	102	140	202	258	282	111	151	219	273	292	114	162	235	289	300
	kW	27.9	27.2	26.1	25.2	24.9	28.2	27.4	26.3	25.5	25.2	28.4	27.6	26.5	25.7	25.5
	BF	0.06	0.07	0.08	0.13	0.30	0.07	0.09	0.09	0.17	0.36	0.08	0.10	0.11	0.20	0.41
95	TC	343	322	291	269	260	348	327	295	275	268	352	331	298	279	275
	SHC	76	114	177	235	260	82	123	193	249	268	88	133	208	263	275
	kW	30.1	29.4	28.3	27.6	27.3	30.3	29.6	28.5	27.8	27.6	30.5	29.7	28.6	27.9	27.8
	BF	0.06	0.07	0.08	0.14	0.31	0.08	0.09	0.10	0.18	0.37	0.09	0.10	0.11	0.21	0.42
105	TC	310	290	261	245	237	313	293	264	250	243	317	297	267	253	249
	SHC	48	87	153	212	237	53	95	167	225	243	59	105	181	238	249
	kW	32.5	31.8	30.8	30.2	30.0	32.7	32.0	31.0	30.4	30.2	32.8	32.1	31.1	30.5	30.4
	BF	0.06	0.07	0.08	0.16	0.33	0.08	0.09	0.10	0.19	0.38	0.09	0.10	0.11	0.22	0.43
115	TC	275	257	231	221	213	277	259	234	224	218	279	261	235	227	223
	SHC	20	59	129	189	213	23	67	142	201	218	28	75	156	212	223
	kW	35.1	34.5	33.7	33.2	33.0	35.2	34.6	33.7	33.3	33.2	35.4	34.7	33.8	33.4	33.3
	BF	0.06	0.08	0.08	0.17	0.34	0.08	0.09	0.10	0.21	0.40	0.09	0.10	0.12	0.24	0.44

LEGEND

48/50P3,P5 units only.

BF — Bypass Factor **kW** — Compressor Motor Power Input
Edb — Entering Dry Bulb **SHC** — Sensible Heat Cap. (1000 Btu/h)
Ewb — Entering Wet Bulb **TC** — Total Cap. (1000 Btu/h) Gross

NOTES:

- The SHC is based on 80 F edb temperature of air entering evaporator coil. For edb temperatures other than 80 F, adjust SHC by multiplying the correction factor and the cfm and then adding or subtracting the value from the SHC.

- Interpolation is permissible.
- Correction Factor = $1.10 \times (1 - BF) \times (edb - 80)$.
- Cooling capacities are gross and do not include deduction for indoor fan motor heat.
- SHC values provided are in subcooling mode with the gas bypass valve closed and reflect the maximum SHC in subcooling mode. The P Series innovative modulating valve system can reduce SHC as needed to meet the supply air set point requirement with minimal change in latent capacity. This will provide variable SHC to meet the space load.

COOLING CAPACITIES (cont)

48/50P2,P3,P4,P5030 (30 TON) HIGH-CAPACITY COIL — HOT GAS REHEAT MODE

Temp (F) Air Ent Condenser (Edb)		Air Entering Evaporator — Ewb (F)													
		75 Dry Bulb 62.5 Wet Bulb (50% RH)							75 Dry Bulb 65.3 Wet Bulb (60% RH)						
		Air Entering Evaporator — Cfm													
		6000	7500	9000	10,500	12,000	13,500	15,000	6000	7500	9000	10,500	12,000	13,500	15,000
80	TC	126	135	141	145	148	150	152	133	142	148	152	154	157	158
	SHC	8	18	29	41	54	67	79	-20	-15	-8	-0	8	17	27
	kW	23.4	23.3	23.3	23.4	23.4	23.5	23.6	24.0	23.9	23.9	24.0	24.0	24.1	24.2
	BF	0.03	0.04	0.06	0.07	0.08	0.10	0.11	0.02	0.04	0.05	0.07	0.08	0.09	0.10
75	TC	129	138	144	148	151	153	155	136	145	150	154	157	159	161
	SHC	9	19	31	43	55	68	81	-18	-13	-7	1	10	19	28
	kW	22.7	22.6	22.6	22.7	22.8	22.8	22.9	23.3	23.2	23.3	23.4	23.4	23.5	23.6
	BF	0.03	0.04	0.06	0.07	0.08	0.10	0.11	0.02	0.04	0.05	0.07	0.08	0.09	0.10
70	TC	131	141	146	150	153	156	158	138	147	153	157	160	163	165
	SHC	11	21	32	44	57	69	82	-17	-12	-5	2	11	20	30
	kW	22.0	22.0	22.0	22.1	22.2	22.3	22.4	22.7	22.6	22.7	22.8	22.9	23.0	23.1
	BF	0.03	0.04	0.06	0.07	0.08	0.10	0.11	0.02	0.04	0.05	0.07	0.08	0.09	0.10
60	TC	130	138	144	147	150	152	154	136	144	149	153	156	158	160
	SHC	11	20	31	43	55	68	81	-17	-13	-6	1	10	19	29
	kW	22.7	22.7	22.9	23.0	23.1	23.2	23.3	23.4	23.5	23.6	23.8	23.9	24.0	24.1
	BF	0.03	0.04	0.06	0.07	0.08	0.10	0.11	0.02	0.04	0.05	0.07	0.08	0.09	0.10
50	TC	134	143	148	152	155	157	159	140	149	154	158	161	164	166
	SHC	13	23	34	45	58	71	84	-15	-10	-4	4	13	22	32
	kW	21.4	21.6	21.7	21.9	22.0	22.2	22.3	22.2	22.3	22.5	22.7	22.8	22.9	23.0
	BF	0.03	0.04	0.06	0.07	0.08	0.10	0.11	0.02	0.04	0.05	0.07	0.08	0.09	0.10
40	TC	138	147	152	157	161	164	166	144	153	160	165	168	171	173
	SHC	16	25	36	48	61	74	87	-13	-8	-1	7	16	26	36
	kW	20.4	20.6	20.8	21.0	21.1	21.3	21.4	21.2	21.4	21.6	21.7	21.9	22.0	22.2
	BF	0.03	0.04	0.06	0.07	0.08	0.09	0.11	0.02	0.04	0.05	0.07	0.08	0.09	0.10

48/50P2,P3,P4,P5030 (30 TON) HIGH-CAPACITY COIL — HOT GAS REHEAT MODE (cont)

Temp (F) Air Ent Condenser (Edb)		Air Entering Evaporator — Ewb (F)													
		75 Dry Bulb 68 Wet Bulb (70% RH)							75 Dry Bulb 70.5 Wet Bulb (80% RH)						
		Air Entering Evaporator — Cfm													
		6000	7500	9000	10,500	12,000	13,500	15,000	6000	7500	9000	10,500	12,000	13,500	15,000
80	TC	139	148	154	158	161	163	165	145	154	160	164	167	170	172
	SHC	-48	-47	-44	-41	-36	-31	-25	-74	-77	-79	-79	-77	-75	-72
	kW	24.7	24.6	24.6	24.6	24.7	24.8	24.9	25.4	25.3	25.3	25.4	25.4	25.5	25.5
	BF	0.01	0.03	0.04	0.06	0.07	0.09	0.10	0.00	0.00	0.02	0.04	0.06	0.07	0.09
75	TC	142	151	156	160	164	167	169	148	157	163	167	171	174	176
	SHC	-46	-45	-43	-39	-34	-29	-23	-73	-76	-77	-77	-75	-73	-70
	kW	24.0	23.9	24.0	24.1	24.2	24.2	24.3	24.8	24.7	24.7	24.8	24.9	24.9	25.0
	BF	0.01	0.03	0.04	0.06	0.07	0.09	0.10	0.00	0.00	0.02	0.04	0.06	0.07	0.09
70	TC	144	153	159	164	168	171	173	150	159	166	171	175	178	180
	SHC	-45	-44	-42	-38	-33	-27	-21	-71	-74	-76	-75	-73	-71	-68
	kW	23.4	23.4	23.4	23.5	23.6	23.7	23.8	24.1	24.1	24.2	24.3	24.3	24.4	24.5
	BF	0.01	0.02	0.04	0.06	0.07	0.09	0.10	0.00	0.00	0.02	0.04	0.06	0.07	0.09
60	TC	142	150	155	159	162	164	166	147	155	161	165	167	170	172
	SHC	-45	-45	-43	-39	-34	-29	-23	-72	-76	-77	-77	-75	-73	-71
	kW	24.2	24.3	24.4	24.6	24.7	24.8	24.9	25.1	25.1	25.2	25.3	25.4	25.5	25.6
	BF	0.01	0.03	0.04	0.06	0.07	0.09	0.10	0.00	0.00	0.02	0.04	0.06	0.08	0.09
50	TC	146	155	160	165	168	171	173	152	160	167	172	175	178	180
	SHC	-43	-43	-40	-36	-31	-25	-19	-69	-73	-74	-73	-72	-69	-66
	kW	23.0	23.2	23.3	23.5	23.6	23.7	23.8	23.9	24.0	24.1	24.3	24.4	24.5	24.6
	BF	0.01	0.03	0.04	0.06	0.07	0.09	0.10	0.00	0.00	0.02	0.04	0.06	0.07	0.09
40	TC	150	160	167	172	176	179	181	157	167	174	179	183	186	188
	SHC	-41	-40	-37	-32	-27	-21	-15	-67	-70	-70	-70	-68	-65	-62
	kW	22.0	22.2	22.4	22.6	22.7	22.8	22.9	22.9	23.0	23.2	23.3	23.5	23.6	23.7
	BF	0.01	0.02	0.04	0.06	0.07	0.09	0.10	0.00	0.00	0.02	0.04	0.06	0.07	0.09

LEGEND

- BF** — Bypass Factor
- Edb** — Entering Dry Bulb
- Ewb** — Entering Wet Bulb
- kW** — Compressor Motor Power Input
- RH** — Relative Humidity
- SHC** — Sensible Heat Cap. (1000 Btu/h)
- TC** — Total Cap. (1000 Btu/h) Gross

6. SHC values provided reflect maximum reheat values with 100% gas bypass. Negative SHC value indicates that the air entering the coil is being heated at 100% gas bypass. The P Series innovative modulating valve system will reduce the gas bypass as required to meet the supply air setpoint with minimal change in latent capacity. The space will NOT be overheated and the unit will provide variable SHC to meet the space load.

NOTES:

1. The SHC is based on 75 F edb temperature of air entering evaporator coil. For edb temperatures other than 75 F, adjust SHC by multiplying the correction factor and the cfm and then adding or subtracting the value from the SHC.
2. Interpolation is permissible.
3. Correction Factor = $1.10 \times (1 - BF) \times (edb - 75)$.
4. Cooling capacities are gross and do not include deduction for indoor fan motor heat.
5. Capacity table includes impact of outdoor fan staging at temperatures below 75 F.

Performance data (cont)



COOLING CAPACITIES (cont)

48/50P2,P3,P4,P5035 (35 TON) STANDARD CAPACITY COIL — STANDARD MODE

Temp (F) Air Entering Condenser (Edb)	Evaporator Air Quantity — Cfm																				
	7,000					8,750					9,625					10,500					
	Evaporator Air — Ewb (F)																				
	75	72	67	62	57	75	72	67	62	57	75	72	67	62	57	75	72	67	62	57	
75	TC	437	419	387	358	332	459	439	407	377	352	466	446	414	384	361	472	453	420	389	370
	SHC	177	200	242	281	318	183	216	266	313	343	190	224	277	328	361	195	231	288	343	370
	KW	27.0	26.3	25.3	24.4	23.8	27.7	27.0	25.9	24.9	24.2	27.9	27.2	26.1	25.1	24.5	28.1	27.4	26.3	25.3	24.7
	BF	0.00	0.00	0.11	0.08	0.08	0.00	0.18	0.11	0.10	0.18	0.00	0.16	0.12	0.10	0.20	0.14	0.16	0.12	0.11	0.24
85	TC	424	406	377	350	323	444	424	395	368	344	450	432	402	375	353	456	438	408	380	363
	SHC	172	196	237	277	313	180	211	261	309	339	185	218	272	325	353	190	225	283	339	363
	KW	29.5	28.8	27.8	27.0	26.6	30.1	29.4	28.4	27.5	26.9	30.4	29.7	28.6	27.7	27.2	30.6	29.9	28.8	27.9	27.4
	BF	0.00	0.00	0.10	0.08	0.08	0.00	0.16	0.11	0.09	0.18	0.00	0.15	0.12	0.10	0.21	0.25	0.15	0.12	0.11	0.26
95	TC	409	394	368	340	311	427	411	384	357	333	433	418	391	363	344	438	423	397	369	353
	SHC	166	191	233	272	304	175	206	256	304	333	179	214	267	319	344	184	220	278	334	353
	KW	32.3	31.7	30.9	30.3	30.0	32.9	32.3	31.4	30.7	30.4	33.2	32.5	31.6	30.9	30.6	33.4	32.7	31.8	31.1	30.8
	BF	0.00	0.10	0.10	0.08	0.09	0.00	0.15	0.10	0.09	0.18	0.27	0.14	0.11	0.10	0.23	0.21	0.14	0.12	0.11	0.28
105	TC	398	382	355	327	298	413	399	371	343	321	419	405	377	349	332	425	410	382	354	341
	SHC	161	187	228	265	295	170	202	251	297	321	175	209	262	313	332	180	216	272	326	341
	KW	35.7	35.2	34.6	34.2	34.4	36.3	35.8	35.1	34.6	34.4	36.5	36.0	35.3	34.8	34.6	36.7	36.2	35.4	35.1	34.8
	BF	0.00	0.18	0.09	0.08	0.11	0.14	0.14	0.10	0.09	0.21	0.21	0.13	0.11	0.10	0.26	0.19	0.13	0.12	0.11	0.30
115	TC	383	367	339	311	284	397	382	354	326	308	403	388	359	332	318	408	393	364	336	327
	SHC	154	181	221	258	283	165	196	243	290	308	170	203	254	304	318	175	210	265	318	327
	KW	39.6	39.3	38.9	39.1	39.9	40.2	39.9	39.4	39.3	39.7	40.5	40.1	39.6	39.5	39.6	40.7	40.3	39.7	39.8	39.7
	BF	0.00	0.15	0.09	0.07	0.14	0.22	0.13	0.10	0.09	0.24	0.18	0.13	0.11	0.10	0.29	0.17	0.13	0.11	0.11	0.33

48/50P2,P3,P4,P5035 (35 TON) STANDARD CAPACITY COIL — STANDARD MODE (cont)

Temp (F) Air Entering Condenser (Edb)	Evaporator Air Quantity — Cfm															
	12,225					14,000					15,000					
	Evaporator Air — Ewb (F)															
	75	72	67	62	57	75	72	67	62	57	75	72	67	62	57	
75	TC	482	463	430	400	386	491	471	438	406	400	496	475	442	411	406
	SHC	204	244	309	371	386	213	257	329	391	400	218	264	340	400	406
	KW	28.5	27.8	26.6	25.6	25.2	28.8	28.0	26.9	25.8	25.6	28.9	28.2	27.0	26.0	25.8
	BF	0.22	0.16	0.13	0.13	0.32	0.20	0.16	0.14	0.16	0.39	0.20	0.16	0.15	0.19	0.42
85	TC	466	447	417	390	379	475	455	424	397	392	478	458	427	400	398
	SHC	199	239	303	366	379	208	252	323	386	392	212	259	334	395	398
	KW	30.9	30.2	29.1	28.2	27.9	31.2	30.5	29.3	28.4	28.3	31.4	30.6	29.4	28.5	28.5
	BF	0.20	0.15	0.13	0.13	0.34	0.19	0.16	0.14	0.17	0.40	0.19	0.16	0.15	0.20	0.43
95	TC	449	433	405	378	369	456	439	412	385	382	460	442	415	389	388
	SHC	193	234	299	360	369	202	246	319	377	382	206	253	330	381	388
	KW	33.7	33.1	32.1	31.4	31.1	34.0	33.3	32.3	31.6	31.5	34.1	33.4	32.4	31.6	31.6
	BF	0.18	0.14	0.13	0.13	0.35	0.18	0.15	0.14	0.17	0.42	0.18	0.16	0.15	0.23	0.45
105	TC	435	418	390	362	356	441	425	396	370	369	444	428	399	376	375
	SHC	189	229	293	348	356	197	241	313	363	369	202	249	324	368	375
	KW	37.1	36.5	35.7	35.2	35.1	37.4	36.8	35.9	35.3	35.3	37.5	36.9	36.0	35.4	35.5
	BF	0.17	0.14	0.13	0.15	0.38	0.17	0.15	0.14	0.21	0.44	0.17	0.15	0.15	0.26	0.46
115	TC	417	400	371	345	341	423	406	377	355	353	425	409	380	359	359
	SHC	183	223	286	337	341	192	235	305	347	353	196	242	317	359	359
	KW	41.1	40.6	39.9	39.8	39.8	41.4	40.9	40.1	39.6	39.9	41.5	41.0	40.2	40.0	40.0
	BF	0.16	0.14	0.13	0.17	0.40	0.16	0.14	0.14	0.25	0.46	0.17	0.15	0.15	0.26	0.49

LEGEND

48/50P3,P5 units only.

BF — Bypass Factor KW — Compressor Motor Power Input
 Edb — Entering Dry Bulb SHC — Sensible Heat Cap. (1000 Btuh)
 Ewb — Entering Wet Bulb TC — Total Cap. (1000 Btuh) Gross

NOTES:

- Direct interpolation is permissible. Do not extrapolate.
- The following formulas may be used:

$$t_{db} = t_{edb} - \frac{\text{sensible capacity (Btuh)}}{1.10 \times \text{cfm}}$$

t_{wb} = Wet-bulb temperature corresponding to enthalpy of air leaving evaporator coil (h_{wb}).

$$h_{wb} = h_{ewb} - \frac{\text{total capacity (Btuh)}}{4.5 \times \text{cfm}}$$

Where: h_{ewb} = Enthalpy of air entering evaporator coil.

- SHC is based on 80 F edb temperature of air entering evaporator coil.

Below 80 F edb, subtract (corr factor x cfm) from SHC.

Above 80 F edb, add (corr factor x cfm) to SHC.

BF	ENTERING AIR DRY-BULB TEMP (F)					
	79	78	77	76	75	under 75
	81	82	83	84	85	over 85
Correction Factor						
.05	1.04	2.09	3.14	4.18	5.22	Use formula shown below
.10	0.99	1.98	2.97	3.96	4.95	
.20	0.88	1.76	2.64	3.52	4.40	

Interpolation is permissible.

Correction Factor = $1.10 \times (1 - BF) \times (edb - 80)$.

- Cooling capacities are gross and do not include deduction for indoor fan motor heat.

COOLING CAPACITIES (cont)

48/50P2,P3,P4,P5035 (35 TON) STANDARD CAPACITY COIL — SUBCOOL MODE

Temp (F) Air Entering Condenser (Edb)		Evaporator Air Quantity — Cfm																			
		7,000					8,750					9,625					10,500				
		Evaporator Air — Ewb (F)																			
		75	72	67	62	57	75	72	67	62	57	75	72	67	62	57	75	72	67	62	57
75	TC	388	364	328	297	270	410	385	346	313	290	413	393	354	319	297	419	401	360	325	304
	SHC	112	134	172	211	249	123	149	194	241	281	124	157	206	255	294	127	165	217	270	304
	kW	26.3	25.6	24.5	23.7	23.0	27.0	26.2	25.1	24.2	23.5	27.2	26.5	25.3	24.3	23.7	27.3	26.8	25.6	24.5	23.9
	BF	0.00	0.01	0.04	0.04	0.05	0.01	0.04	0.05	0.06	0.12	0.02	0.05	0.06	0.07	0.15	0.03	0.06	0.07	0.08	0.19
85	TC	360	337	304	275	251	378	355	319	289	270	386	362	325	294	276	392	368	330	299	282
	SHC	88	112	151	192	233	97	125	171	220	261	102	131	181	234	273	106	138	192	247	282
	kW	28.4	27.7	26.7	25.9	25.3	29.1	28.3	27.2	26.3	25.7	29.4	28.6	27.4	26.5	25.9	29.6	28.8	27.6	26.6	26.1
	BF	0.00	0.02	0.04	0.04	0.06	0.01	0.04	0.05	0.06	0.13	0.02	0.05	0.06	0.07	0.16	0.04	0.06	0.07	0.08	0.20
95	TC	331	311	280	253	235	346	324	292	265	250	352	330	297	269	255	357	335	302	273	259
	SHC	65	89	130	173	218	71	99	148	199	242	74	105	157	212	253	78	111	167	224	259
	kW	30.8	30.1	29.1	28.4	27.9	31.4	30.7	29.6	28.8	28.3	31.7	30.9	29.8	28.9	28.4	31.9	31.1	30.0	29.1	28.6
	BF	0.00	0.02	0.04	0.04	0.08	0.02	0.04	0.05	0.06	0.14	0.02	0.05	0.06	0.07	0.17	0.04	0.06	0.07	0.08	0.22
105	TC	303	284	256	230	217	314	294	265	240	229	318	298	269	244	225	322	301	272	247	236
	SHC	42	67	110	154	200	44	74	125	178	222	47	78	133	190	223	49	83	142	202	236
	kW	33.5	32.8	32.0	31.3	30.9	34.0	33.3	32.3	31.6	31.2	34.2	33.5	32.5	31.7	31.2	34.4	33.7	32.6	31.8	31.5
	BF	0.00	0.02	0.04	0.04	0.09	0.02	0.04	0.05	0.06	0.16	0.03	0.05	0.06	0.07	0.19	0.04	0.06	0.07	0.08	0.23
115	TC	274	256	230	207	188	281	263	237	216	198	284	266	239	207	199	287	269	237	210	200
	SHC	18	45	90	135	172	18	49	103	153	192	19	52	110	160	199	20	56	112	169	200
	kW	36.5	35.9	35.2	34.6	34.0	36.9	36.3	35.4	34.8	34.3	37.1	36.4	35.5	34.7	34.4	37.2	36.5	35.5	34.8	34.5
	BF	0.00	0.02	0.04	0.04	0.11	0.02	0.04	0.05	0.06	0.17	0.03	0.05	0.06	0.08	0.20	0.04	0.06	0.07	0.09	0.25

48/50P2,P3,P4,P5035 (35 TON) STANDARD CAPACITY COIL — SUBCOOL MODE (cont)

Temp (F) Air Entering Condenser (Edb)		Evaporator Air Quantity — Cfm														
		12,225					14,000					15,000				
		Evaporator Air — Ewb (F)														
		75	72	67	62	57	75	72	67	62	57	75	72	67	62	57
75	TC	435	407	372	335	320	451	413	377	343	334	441	427	381	349	342
	SHC	142	175	239	297	320	159	186	258	322	334	150	204	269	331	342
	kW	27.9	27.0	25.9	24.8	24.4	28.4	27.2	26.1	25.1	24.8	28.0	27.6	26.2	25.3	25.1
	BF	0.06	0.07	0.08	0.10	0.28	0.08	0.09	0.10	0.13	0.35	0.09	0.10	0.10	0.16	0.38
85	TC	402	378	340	307	296	404	386	347	315	307	420	391	350	320	314
	SHC	114	152	213	272	296	118	165	233	291	307	134	174	244	302	314
	kW	30.0	29.2	27.9	26.9	26.5	30.0	29.5	28.2	27.2	26.9	30.6	29.7	28.3	27.3	27.1
	BF	0.06	0.07	0.08	0.11	0.29	0.08	0.09	0.10	0.15	0.36	0.09	0.10	0.10	0.17	0.39
95	TC	366	343	308	277	271	373	349	313	288	281	376	353	316	292	287
	SHC	85	122	186	247	271	93	135	205	265	281	97	142	216	275	287
	kW	32.3	31.4	30.2	29.2	29.0	32.5	31.7	30.5	29.5	29.3	32.7	31.9	30.6	29.7	29.5
	BF	0.06	0.08	0.08	0.11	0.30	0.08	0.09	0.10	0.16	0.37	0.09	0.10	0.11	0.18	0.40
105	TC	328	307	277	255	246	334	312	281	261	255	337	314	283	264	259
	SHC	55	93	159	223	246	62	104	177	239	255	66	110	187	248	259
	kW	34.7	33.9	32.8	32.0	31.8	35.0	34.2	33.0	32.3	32.1	35.1	34.3	33.1	32.4	32.2
	BF	0.06	0.08	0.08	0.13	0.31	0.08	0.09	0.10	0.17	0.38	0.09	0.10	0.11	0.20	0.41
115	TC	291	272	240	219	208	295	275	243	223	215	296	276	245	224	219
	SHC	24	64	128	187	208	29	74	145	202	215	33	78	155	209	219
	kW	37.5	36.7	35.6	35.0	34.8	37.7	36.9	35.8	35.2	35.1	37.8	37.0	35.9	35.3	35.2
	BF	0.06	0.08	0.08	0.15	0.33	0.08	0.09	0.10	0.19	0.39	0.09	0.10	0.11	0.21	0.42

LEGEND

48/50P3,P5 units only.

BF — Bypass Factor **kW** — Compressor Motor Power Input
Edb — Entering Dry Bulb **SHC** — Sensible Heat Cap. (1000 Btu/h)
Ewb — Entering Wet Bulb **TC** — Total Cap. (1000 Btu/h) Gross

NOTES:

- The SHC is based on 80 F edb temperature of air entering evaporator coil. For edb temperatures other than 80 F, adjust SHC by multiplying the correction factor and the cfm and then adding or subtracting the value from the SHC.

- Interpolation is permissible.
- Correction Factor = $1.10 \times (1 - BF) \times (edb - 80)$.
- Cooling capacities are gross and do not include deduction for indoor fan motor heat.
- SHC values provided are in subcooling mode with the gas bypass valve closed and reflect the maximum SHC in subcooling mode. The P Series innovative modulating valve system can reduce SHC as needed to meet the supply air set point requirement with minimal change in latent capacity. This will provide variable SHC to meet the space load.

Performance data (cont)



COOLING CAPACITIES (cont)

48/50P2,P3,P4,P5035 (35 TON) STANDARD CAPACITY COIL — HOT GAS REHEAT MODE

Temp (F) Air Ent Condenser (Edb)	Air Entering Evaporator — Ewb (F)														
	75 Dry Bulb 62.5 Wet Bulb (50% RH)							75 Dry Bulb 65.3 Wet Bulb (60% RH)							
	Air Entering Evaporator — Cfm														
	7000	8750	9625	10,500	12,250	14,000	15,000	7000	8750	9625	10,500	12,250	14,000	15,000	
80	TC	150	158	161	163	167	170	171	156	164	167	170	174	178	179
	SHC	24	36	43	50	64	80	88	-8	-1	3	8	18	29	36
	kW	24.5	24.7	24.8	24.9	25.0	25.2	25.2	25.2	25.2	25.5	25.6	25.8	25.9	26.0
	BF	0.04	0.05	0.06	0.07	0.08	0.10	0.11	0.03	0.05	0.06	0.07	0.08	0.10	0.10
75	TC	152	160	163	166	170	173	175	159	167	170	173	178	182	183
	SHC	25	37	44	51	66	81	90	-6	1	5	10	20	31	38
	kW	23.8	24.0	24.1	24.2	24.4	24.6	24.6	24.6	24.8	24.9	25.0	25.2	25.3	25.4
	BF	0.04	0.05	0.06	0.07	0.08	0.10	0.11	0.03	0.05	0.06	0.07	0.08	0.10	0.10
70	TC	154	163	166	169	174	177	179	161	170	174	177	182	185	187
	SHC	26	39	46	53	68	83	92	-5	2	7	12	22	33	40
	kW	23.2	23.4	23.5	23.6	23.8	24.0	24.1	24.0	24.2	24.3	24.4	24.6	24.7	24.8
	BF	0.04	0.05	0.06	0.07	0.08	0.10	0.11	0.03	0.05	0.06	0.07	0.08	0.10	0.10
60	TC	152	160	162	165	168	171	172	158	166	169	171	175	178	180
	SHC	26	38	44	51	66	81	90	-6	1	5	10	20	31	38
	kW	24.1	24.4	24.5	24.7	24.9	25.1	25.1	24.9	25.2	25.4	25.5	25.7	25.9	26.0
	BF	0.04	0.05	0.06	0.07	0.08	0.10	0.11	0.03	0.05	0.06	0.07	0.08	0.10	0.10
50	TC	156	164	167	170	175	178	180	163	171	175	178	182	186	187
	SHC	28	40	47	55	72	88	95	-3	4	9	14	24	37	45
	kW	22.8	23.2	23.3	23.5	23.7	23.9	24.0	23.7	24.0	24.2	24.3	24.6	24.8	24.9
	BF	0.04	0.05	0.06	0.07	0.08	0.10	0.11	0.03	0.05	0.06	0.07	0.08	0.10	0.10
40	TC	160	169	173	176	181	185	186	168	178	181	184	189	193	194
	SHC	30	44	51	58	73	91	101	-0	8	12	17	28	43	49
	kW	21.8	22.2	22.3	22.5	22.7	23.0	23.1	22.6	23.0	23.2	23.3	23.6	23.8	23.9
	BF	0.04	0.05	0.06	0.07	0.08	0.10	0.11	0.03	0.05	0.06	0.07	0.08	0.10	0.10

48/50P2,P3,P4,P5035 (35 TON) STANDARD CAPACITY COIL — HOT GAS REHEAT MODE (cont)

Temp (F) Air Ent Condenser (Edb)	Air Entering Evaporator — Ewb (F)														
	75 Dry Bulb 68 Wet Bulb (70% RH)							75 Dry Bulb 70.5 Wet Bulb (80% RH)							
	Air Entering Evaporator — Cfm														
	7000	8750	9625	10,500	12,250	14,000	15,000	7000	8750	9625	10,500	12,250	14,000	15,000	
80	TC	163	171	174	177	182	185	187	169	178	182	185	189	193	194
	SHC	-39	-37	-34	-32	-26	-19	-15	-69	-70	-70	-69	-68	-65	-63
	kW	26.0	26.2	26.3	26.4	26.5	26.7	26.7	26.8	27.0	27.1	27.1	27.3	27.4	27.5
	BF	0.01	0.04	0.05	0.06	0.08	0.09	0.10	0.00	0.01	0.02	0.03	0.06	0.08	0.09
75	TC	165	175	178	181	186	189	191	172	182	186	189	193	197	199
	SHC	-37	-35	-33	-30	-24	-17	-13	-67	-68	-68	-67	-66	-63	-61
	kW	25.4	25.6	25.7	25.8	25.9	26.1	26.1	26.2	26.3	26.4	26.5	26.7	26.8	26.9
	BF	0.01	0.04	0.05	0.06	0.08	0.09	0.10	0.00	0.01	0.02	0.03	0.06	0.08	0.09
70	TC	168	178	182	185	190	193	195	176	186	189	193	197	201	203
	SHC	-36	-33	-31	-28	-22	-15	-11	-64	-66	-66	-66	-64	-61	-59
	kW	24.8	25.0	25.1	25.2	25.3	25.5	25.6	25.5	25.8	25.9	25.9	26.1	26.2	26.3
	BF	0.01	0.04	0.05	0.06	0.07	0.09	0.10	0.00	0.01	0.02	0.03	0.06	0.08	0.09
60	TC	164	172	175	178	182	185	187	170	179	182	185	189	192	194
	SHC	-37	-35	-33	-30	-24	-17	-13	-66	-68	-68	-68	-66	-63	-61
	kW	25.8	26.1	26.2	26.4	26.6	26.8	26.9	26.7	27.0	27.1	27.2	27.4	27.6	27.7
	BF	0.01	0.04	0.05	0.06	0.08	0.09	0.10	0.00	0.01	0.02	0.03	0.06	0.08	0.09
50	TC	170	179	183	185	190	193	195	177	186	190	192	197	200	202
	SHC	-33	-31	-29	-26	-20	-10	-5	-61	-64	-64	-64	-62	-54	-56
	kW	24.5	24.9	25.1	25.2	25.4	25.7	25.8	25.4	25.8	25.9	26.1	26.3	26.5	26.6
	BF	0.01	0.04	0.05	0.06	0.08	0.09	0.10	0.00	0.01	0.02	0.03	0.06	0.08	0.09
40	TC	175	185	189	192	197	200	202	183	193	196	199	204	208	209
	SHC	-30	-28	-25	-22	-16	-9	-4	-58	-61	-61	-60	-58	-55	-50
	kW	23.5	23.9	24.0	24.2	24.4	24.6	24.8	24.4	24.8	24.9	25.0	25.3	25.5	25.6
	BF	0.01	0.04	0.05	0.06	0.07	0.09	0.10	0.00	0.00	0.01	0.03	0.06	0.07	0.09

LEGEND

- BF** — Bypass Factor
- Edb** — Entering Dry Bulb
- Ewb** — Entering Wet Bulb
- kW** — Compressor Motor Power Input
- RH** — Relative Humidity
- SHC** — Sensible Heat Cap. (1000 Btu/h)
- TC** — Total Cap. (1000 Btu/h) Gross

6. SHC values provided reflect maximum reheat values with 100% gas bypass. Negative SHC value indicates that the air entering the coil is being heated at 100% gas bypass. The P Series innovative modulating valve system will reduce the gas bypass as required to meet the supply air setpoint with minimal change in latent capacity. The space will NOT be overheated and the unit will provide variable SHC to meet the space load.

NOTES:

1. The SHC is based on 75 F edb temperature of air entering evaporator coil. For edb temperatures other than 75 F, adjust SHC by multiplying the correction factor and the cfm and then adding or subtracting the value from the SHC.
2. Interpolation is permissible.
3. Correction Factor = $1.10 \times (1 - BF) \times (edb - 75)$.
4. Cooling capacities are gross and do not include deduction for indoor fan motor heat.
5. Capacity table includes impact of outdoor fan staging at temperatures below 75 F.

COOLING CAPACITIES (cont)

48/50P2,P3,P4,P5040 (40 TON) STANDARD CAPACITY COIL — STANDARD MODE

Temp (F) Air Entering Condenser (Edb)		Evaporator Air Quantity — Cfm																			
		8,000					10,000					12,000					14,000				
		Evaporator Air — Ewb (F)																			
		75	72	67	62	57	75	72	67	62	57	75	72	67	62	57	75	72	67	62	57
75	TC	477	458	420	383	348	501	483	443	405	367	519	497	458	420	383	533	508	469	431	397
	SHC	195	210	246	282	317	206	220	271	313	348	207	237	290	339	371	210	249	307	364	397
	KW	24.8	24.5	24.0	23.6	23.3	25.3	24.9	24.3	23.9	23.5	25.7	25.2	24.6	24.1	23.5	26.0	25.5	24.8	24.2	23.9
	BF	0.00	0.00	0.00	0.33	0.26	0.00	0.00	0.39	0.31	0.31	0.00	0.00	0.36	0.32	0.37	0.00	0.22	0.36	0.33	0.39
85	TC	467	447	409	371	338	490	471	431	393	356	507	485	446	407	370	520	497	457	419	388
	SHC	191	206	241	277	311	202	218	266	308	340	203	233	286	334	367	205	246	302	358	387
	KW	27.5	27.3	26.9	26.6	26.3	28.0	27.7	27.1	26.8	26.5	28.3	27.9	27.4	27.0	26.6	28.6	28.2	27.6	27.1	26.8
	BF	0.00	0.00	0.00	0.31	0.26	0.00	0.00	0.36	0.30	0.31	0.00	0.00	0.35	0.31	0.35	0.00	0.44	0.36	0.33	0.41
95	TC	455	435	397	359	326	479	457	418	379	341	494	470	431	393	360	504	482	441	404	377
	SHC	186	199	237	271	304	190	214	261	302	334	194	229	280	328	356	203	241	296	352	377
	KW	30.7	30.6	30.2	30.0	29.8	31.2	30.9	30.5	30.2	29.9	31.5	31.1	30.7	30.4	30.0	31.7	31.3	30.9	30.5	30.3
	BF	0.00	0.00	0.00	0.30	0.26	0.00	0.00	0.34	0.29	0.30	0.00	0.00	0.34	0.31	0.37	0.00	0.42	0.35	0.32	0.42
105	TC	440	420	382	346	312	463	440	401	364	330	477	453	413	377	347	486	464	424	387	364
	SHC	180	192	231	265	295	184	209	254	295	321	189	223	269	321	347	199	235	289	345	364
	KW	34.4	34.4	34.1	34.2	34.5	34.9	34.7	34.4	34.2	34.3	35.1	34.9	34.6	34.3	34.4	35.3	35.1	34.8	34.3	34.4
	BF	0.00	0.00	0.42	0.29	0.27	0.00	0.00	0.32	0.29	0.33	0.00	0.44	0.33	0.30	0.38	0.00	0.39	0.35	0.32	0.44
115	TC	422	406	365	330	297	443	420	383	347	315	456	434	395	359	334	466	443	404	368	350
	SHC	174	187	224	257	283	178	203	247	288	312	183	217	265	314	334	193	229	282	336	350
	KW	38.7	38.4	38.9	39.4	40.3	39.1	39.0	38.9	39.2	39.8	39.3	39.2	39.1	39.1	39.6	39.5	39.4	39.1	39.2	39.4
	BF	0.00	0.00	0.34	0.28	0.29	0.00	0.00	0.31	0.28	0.34	0.00	0.39	0.32	0.29	0.40	0.00	0.37	0.34	0.32	0.46

48/50P2,P3,P4,P5040 (40 TON) STANDARD CAPACITY COIL — STANDARD MODE (cont)

Temp (F) Air Entering Condenser (Edb)		Evaporator Air Quantity — Cfm														
		16,000					18,000					20,000				
		Evaporator Air — Ewb (F)														
		75	72	67	62	57	75	72	67	62	57	75	72	67	62	57
75	TC	542	518	478	440	413	549	525	486	447	426	557	531	491	453	438
	SHC	220	261	324	386	413	228	272	339	406	426	237	282	354	424	438
	KW	26.2	25.7	24.9	24.4	24.0	26.4	25.8	25.1	24.5	24.2	26.5	25.9	25.2	24.6	24.4
	BF	0.00	0.43	0.37	0.35	0.45	0.00	0.41	0.38	0.37	0.49	0.49	0.41	0.39	0.39	0.53
85	TC	527	505	465	427	402	535	512	472	434	416	541	518	478	440	427
	SHC	216	257	319	380	402	223	268	334	401	416	232	277	350	415	427
	KW	28.8	28.3	27.7	27.3	27.0	29.0	28.5	27.8	27.3	27.1	29.1	28.6	27.9	27.5	27.3
	BF	0.00	0.41	0.37	0.35	0.46	0.26	0.41	0.38	0.36	0.50	0.48	0.41	0.39	0.39	0.54
95	TC	512	490	450	412	391	520	496	456	419	404	527	502	462	423	415
	SHC	212	252	313	373	391	219	263	329	391	404	227	272	344	402	415
	KW	31.8	31.5	31.0	30.6	30.4	32.1	31.6	31.1	30.7	30.5	32.2	31.8	31.2	30.8	30.7
	BF	0.00	0.40	0.36	0.35	0.47	0.53	0.40	0.37	0.37	0.52	0.46	0.40	0.38	0.39	0.55
105	TC	494	471	432	394	378	502	477	438	401	391	507	483	443	405	400
	SHC	208	246	306	365	378	215	258	322	378	391	222	267	337	395	400
	KW	35.4	35.2	34.8	34.5	34.4	35.7	35.2	34.9	34.5	34.4	35.8	35.5	35.0	34.6	34.6
	BF	0.50	0.38	0.35	0.35	0.49	0.46	0.37	0.37	0.38	0.53	0.44	0.39	0.38	0.40	0.57
115	TC	473	450	411	375	365	480	456	417	382	375	484	461	421	389	384
	SHC	201	240	299	354	365	209	250	314	363	375	215	260	330	373	384
	KW	39.7	39.6	39.1	39.3	39.0	39.9	39.7	39.2	39.3	39.3	40.0	39.7	39.2	39.0	39.3
	BF	0.47	0.37	0.35	0.35	0.51	0.42	0.37	0.36	0.40	0.55	0.42	0.38	0.37	0.45	0.59

LEGEND

48/50P3,P5 units only.

BF — Bypass Factor kW — Compressor Motor Power Input
 Edb — Entering Dry Bulb SHC — Sensible Heat Cap. (1000 Btuh)
 Ewb — Entering Wet Bulb TC — Total Cap. (1000 Btuh) Gross

NOTES:

- Direct interpolation is permissible. Do not extrapolate.
- The following formulas may be used:

$$t_{db} = t_{edb} - \frac{\text{sensible capacity (Btuh)}}{1.10 \times \text{cfm}}$$

t_{lwb} = Wet-bulb temperature corresponding to enthalpy of air leaving evaporator coil (h_{lwb}).

$$h_{lwb} = h_{ewb} - \frac{\text{total capacity (Btuh)}}{4.5 \times \text{cfm}}$$

Where: h_{ewb} = Enthalpy of air entering evaporator coil.

- SHC is based on 80 F edb temperature of air entering evaporator coil.
 Below 80 F edb, subtract (corr factor x cfm) from SHC.
 Above 80 F edb, add (corr factor x cfm) to SHC.

BF	ENTERING AIR DRY-BULB TEMP (F)					
	79	78	77	76	75	under 75
	81	82	83	84	85	over 85
Correction Factor						
.05	1.04	2.09	3.14	4.18	5.22	Use formula shown below
.10	0.99	1.98	2.97	3.96	4.95	
.20	0.88	1.76	2.64	3.52	4.40	

Interpolation is permissible.
 Correction Factor = 1.10 x (1 - BF) x (edb - 80).

- Cooling capacities are gross and do not include deduction for indoor fan motor heat.

Performance data (cont)



COOLING CAPACITIES (cont)

48/50P2,P3,P4,P5040 (40 TON) STANDARD CAPACITY COIL — SUBCOOL MODE

Temp (F) Air Entering Condenser (Edb)		Evaporator Air Quantity — Cfm																			
		8,000					10,000					12,000					14,000				
		Evaporator Air — Ewb (F)																			
		75	72	67	62	57	75	72	67	62	57	75	72	67	62	57	75	72	67	62	57
75	TC	453	431	395	358	329	479	450	418	379	340	498	473	433	393	363	513	486	455	406	377
	SHC	162	177	207	247	288	175	185	233	275	313	178	201	252	300	342	183	212	281	326	362
	kW	24.6	24.2	23.5	22.9	23.5	25.1	24.5	23.9	23.3	22.7	25.5	25.0	24.2	23.5	23.1	25.8	25.3	25.6	23.8	23.3
	BF	0.00	0.00	0.00	0.12	0.30	0.00	0.00	0.14	0.37	0.34	0.00	0.00	0.14	0.36	0.37	0.00	0.18	0.43	0.36	0.42
85	TC	434	413	379	344	308	460	437	401	363	329	478	453	416	377	349	490	465	426	388	361
	SHC	148	161	193	235	269	156	177	220	263	302	157	186	239	288	329	167	197	255	311	347
	kW	27.1	26.7	26.1	25.5	25.1	27.6	27.1	26.5	25.8	25.4	28.0	27.5	26.7	26.1	25.6	28.2	27.7	26.9	26.3	25.8
	BF	0.00	0.00	0.19	0.12	0.31	0.00	0.00	0.14	0.37	0.34	0.00	0.20	0.14	0.36	0.38	0.00	0.17	0.42	0.37	0.43
95	TC	416	396	362	325	294	439	418	384	357	316	456	445	397	373	332	467	459	406	360	345
	SHC	134	146	180	220	257	141	163	206	261	290	142	177	224	289	312	151	197	241	287	330
	kW	29.9	29.6	29.0	28.4	28.1	30.4	30.0	29.4	29.9	28.4	30.8	30.9	29.6	30.0	28.6	31.0	31.5	29.8	29.0	28.8
	BF	0.00	0.00	0.16	0.12	0.31	0.00	0.00	0.13	0.36	0.34	0.00	0.18	0.14	0.35	0.40	0.00	0.17	0.42	0.37	0.44
105	TC	391	377	346	322	287	418	397	364	340	300	434	414	376	353	316	444	422	385	345	328
	SHC	114	133	164	221	254	126	148	192	249	275	126	153	209	273	296	134	166	225	277	314
	kW	33.3	32.9	32.4	33.0	32.7	33.7	33.3	32.7	33.6	31.8	34.0	33.6	33.0	34.0	32.0	34.3	33.8	33.1	33.1	32.2
	BF	0.00	0.00	0.15	0.11	0.32	0.00	0.00	0.13	0.36	0.36	0.00	0.17	0.14	0.36	0.41	0.00	0.16	0.41	0.36	0.45
115	TC	374	360	325	305	261	395	374	342	309	283	409	389	354	320	299	418	398	362	329	309
	SHC	103	123	154	209	226	108	132	176	222	259	110	136	194	245	280	117	149	209	266	296
	kW	37.0	36.8	36.2	37.0	35.2	37.4	37.0	36.5	36.0	35.6	37.7	37.3	36.8	36.2	35.9	37.9	37.5	36.9	36.4	36.1
	BF	0.00	0.00	0.13	0.11	0.37	0.00	0.18	0.12	0.35	0.37	0.00	0.16	0.13	0.35	0.42	0.20	0.15	0.41	0.37	0.46

48/50P2,P3,P4,P5040 (40 TON) STANDARD CAPACITY COIL — SUBCOOL MODE (cont)

Temp (F) Air Entering Condenser (Edb)		Evaporator Air Quantity — Cfm														
		16,000					18,000					20,000				
		Evaporator Air — Ewb (F)														
		75	72	67	62	57	75	72	67	62	57	75	72	67	62	57
75	TC	523	496	452	414	393	532	504	460	420	405	540	511	466	427	404
	SHC	192	225	285	346	380	196	236	301	364	405	199	246	316	376	385
	kW	26.0	25.5	24.6	23.9	24.6	26.2	25.6	24.8	24.0	24.9	26.4	25.8	24.9	24.2	23.8
	BF	0.00	0.18	0.42	0.38	0.45	0.23	0.18	0.42	0.41	0.49	0.21	0.50	0.42	0.44	0.57
85	TC	500	474	434	397	368	508	482	442	416	378	515	489	434	419	388
	SHC	175	209	271	332	368	179	220	278	356	378	182	230	288	377	388
	kW	28.4	27.9	27.1	26.4	25.9	28.6	28.1	27.3	27.8	26.1	28.8	28.2	27.2	27.4	26.3
	BF	0.25	0.17	0.41	0.38	0.45	0.21	0.17	0.42	0.40	0.47	0.20	0.49	0.42	0.43	0.51
95	TC	476	453	414	377	351	484	476	421	381	363	491	466	441	390	373
	SHC	158	193	256	316	351	161	219	271	333	363	165	214	300	348	373
	kW	31.2	30.7	30.0	29.3	28.9	31.4	31.9	30.1	29.4	29.1	31.6	31.0	31.6	29.6	29.3
	BF	0.22	0.17	0.41	0.39	0.46	0.20	0.17	0.41	0.41	0.50	0.19	0.48	0.42	0.44	0.54
105	TC	452	430	392	358	335	459	437	389	362	346	466	459	395	369	356
	SHC	141	177	240	301	335	144	187	245	315	346	148	213	260	323	356
	kW	34.5	34.0	33.3	32.7	32.3	34.6	34.1	33.2	32.8	32.5	34.8	35.3	33.4	32.9	32.7
	BF	0.20	0.16	0.41	0.40	0.46	0.19	0.16	0.41	0.42	0.51	0.19	0.47	0.42	0.44	0.55
115	TC	427	405	369	335	316	450	411	375	344	327	441	416	380	351	336
	SHC	119	159	224	284	316	143	169	239	298	327	132	178	252	310	336
	kW	38.1	37.7	37.1	36.5	36.2	39.2	37.8	37.2	36.7	36.4	38.5	38.0	37.3	36.8	36.5
	BF	0.18	0.16	0.41	0.41	0.48	0.18	0.16	0.41	0.44	0.52	0.18	0.47	0.42	0.46	0.56

LEGEND

48/50P3,P5 units only.

BF — Bypass Factor **kW** — Compressor Motor Power Input
Edb — Entering Dry Bulb **SHC** — Sensible Heat Cap. (1000 Btu/h)
Ewb — Entering Wet Bulb **TC** — Total Cap. (1000 Btu/h) Gross

NOTES:

- The SHC is based on 80 F edb temperature of air entering evaporator coil. For edb temperatures other than 80 F, adjust SHC by multiplying the correction factor and the cfm and then adding or subtracting the value from the SHC.

- Interpolation is permissible.
- Correction Factor = $1.10 \times (1 - BF) \times (edb - 80)$.
- Cooling capacities are gross and do not include deduction for indoor fan motor heat.
- SHC values provided are in subcooling mode with the gas bypass valve closed and reflect the maximum SHC in subcooling mode. The P Series innovative modulating valve system can reduce SHC as needed to meet the supply air set point requirement with minimal change in latent capacity. This will provide variable SHC to meet the space load.

COOLING CAPACITIES (cont)

48/50P2,P3,P4,P5040 (40 TON) STANDARD CAPACITY COIL — HOT GAS REHEAT MODE

Temp (F) Air Ent Condenser (Edb)		Air Entering Evaporator — Ewb (F)													
		75 Dry Bulb 62.5 Wet Bulb (50% RH)							75 Dry Bulb 65.3 Wet Bulb (60% RH)						
		Air Entering Evaporator — Cfm													
		8000	10,000	12,000	14,000	16,000	18,000	20,000	8000	10,000	12,000	14,000	16,000	18,000	20,000
80	TC	142	153	161	165	169	173	176	152	163	171	176	180	184	187
	SHC	-12	1	12	23	34	45	55	-37	-37	-27	-19	-11	-2	6
	kW	26.0	25.8	25.9	26.3	26.3	26.2	26.2	26.5	26.1	26.1	26.5	26.4	26.5	26.5
	BF	0.20	0.14	0.15	0.44	0.42	0.42	0.43	0.00	0.00	0.17	0.16	0.16	0.46	0.45
75	TC	145	156	164	168	173	176	179	155	166	174	179	184	187	190
	SHC	-11	3	14	25	36	47	58	-36	-35	-25	-17	-9	-1	7
	kW	25.2	25.0	25.0	25.4	25.4	25.4	25.4	25.6	25.4	25.3	25.7	25.7	25.7	25.8
	BF	0.00	0.15	0.15	0.44	0.42	0.42	0.43	0.00	0.00	0.17	0.16	0.16	0.46	0.45
70	TC	143	154	162	166	170	174	176	152	163	170	176	180	184	186
	SHC	-11	2	13	24	35	47	55	-36	-36	-26	-18	-10	-2	6
	kW	25.8	25.6	25.7	26.1	26.1	26.1	26.1	26.6	26.5	26.4	26.4	26.4	26.5	26.6
	BF	0.20	0.14	0.15	0.44	0.42	0.42	0.43	0.00	0.00	0.17	0.16	0.16	0.46	0.45
60	TC	148	159	167	172	176	180	182	157	169	177	182	186	190	193
	SHC	-8	5	16	27	38	49	60	-33	-33	-23	-15	-7	1	9
	kW	24.2	24.2	24.2	24.5	24.6	24.7	24.7	24.8	24.7	24.7	25.0	25.0	25.1	25.2
	BF	0.00	0.15	0.15	0.44	0.42	0.42	0.43	0.00	0.00	0.17	0.17	0.17	0.46	0.45
50	TC	152	163	171	176	181	184	187	162	173	181	187	191	195	198
	SHC	-5	8	19	30	40	51	62	-30	-31	-21	-12	-4	4	12
	kW	22.9	22.9	23.1	23.3	23.4	23.4	23.5	23.6	23.7	23.8	23.9	24.0	24.0	24.1
	BF	0.00	0.15	0.15	0.44	0.42	0.42	0.43	0.00	0.00	0.18	0.17	0.17	0.46	0.45
40	TC	155	167	175	181	186	189	193	165	177	186	193	197	201	204
	SHC	-3	10	21	32	43	54	65	-29	-30	-19	-9	-2	6	14
	kW	22.0	22.1	22.2	22.4	22.4	22.5	22.6	22.9	23.0	23.0	23.1	23.2	23.3	23.3
	BF	0.00	0.16	0.15	0.44	0.42	0.42	0.43	0.00	0.00	0.19	0.17	0.17	0.47	0.46

48/50P2,P3,P4,P5040 (40 TON) STANDARD CAPACITY COIL — HOT GAS REHEAT MODE (cont)

Temp (F) Air Ent Condenser (Edb)		Air Entering Evaporator — Ewb (F)													
		75 Dry Bulb 68 Wet Bulb (70% RH)							75 Dry Bulb 70.5 Wet Bulb (80% RH)						
		Air Entering Evaporator — Cfm													
		8000	10,000	12,000	14,000	16,000	18,000	20,000	8000	10,000	12,000	14,000	16,000	18,000	20,000
80	TC	160	172	180	186	191	194	197	169	180	189	196	200	204	207
	SHC	-58	-65	-66	-63	-56	-50	-45	-84	-85	-87	-97	-93	-96	-92
	kW	27.1	27.1	27.0	26.9	26.9	27.0	27.0	27.5	27.5	27.2	27.4	27.3	27.4	27.4
	BF	0.00	0.00	0.00	0.21	0.19	0.18	0.18	0.00	0.00	0.00	0.00	0.00	0.00	0.23
75	TC	163	175	183	189	194	198	200	172	183	193	200	204	208	211
	SHC	-56	-63	-64	-61	-54	-48	-43	-82	-83	-85	-95	-91	-94	-90
	kW	26.3	26.3	26.2	26.2	26.2	26.2	26.3	26.7	26.5	26.5	26.7	26.6	26.7	26.7
	BF	0.00	0.00	0.00	0.22	0.19	0.19	0.19	0.00	0.00	0.00	0.00	0.00	0.00	0.24
70	TC	162	172	180	185	190	193	196	170	180	189	195	199	203	205
	SHC	-56	-64	-64	-62	-56	-49	-44	-83	-84	-86	-95	-92	-95	-92
	kW	26.9	27.0	27.0	27.0	27.0	27.1	27.1	27.4	27.3	27.4	27.5	27.5	27.6	27.7
	BF	0.00	0.00	0.00	0.21	0.19	0.18	0.18	0.00	0.00	0.00	0.00	0.00	0.26	0.22
60	TC	166	178	185	191	196	200	202	175	186	195	201	206	209	212
	SHC	-54	-61	-62	-62	-52	-47	-41	-80	-80	-84	-93	-90	-92	-89
	kW	25.5	25.6	25.6	25.7	25.7	25.7	25.8	26.0	26.0	26.1	26.3	26.4	26.5	26.5
	BF	0.00	0.00	0.00	0.22	0.19	0.19	0.19	0.00	0.00	0.00	0.00	0.00	0.00	0.24
50	TC	171	184	191	197	202	206	209	178	191	201	208	213	217	220
	SHC	-51	-59	-59	-59	-50	-44	-38	-76	-77	-81	-89	-87	-89	-86
	kW	24.3	24.5	24.6	24.7	24.7	24.8	24.9	25.0	25.0	25.2	25.4	25.4	25.5	25.6
	BF	0.00	0.00	0.00	0.00	0.20	0.19	0.19	0.00	0.00	0.00	0.00	0.00	0.00	0.00
40	TC	174	189	197	203	208	213	216	182	197	207	214	220	224	227
	SHC	-44	-55	-57	-56	-47	-41	-36	-72	-75	-78	-86	-85	-86	-86
	kW	23.3	23.7	23.8	23.9	23.9	24.0	24.1	24.1	24.1	24.2	24.4	24.6	24.7	24.8
	BF	0.00	0.00	0.00	0.00	0.22	0.20	0.19	0.00	0.00	0.00	0.00	0.00	0.00	0.00

LEGEND

- BF** — Bypass Factor
- Edb** — Entering Dry Bulb
- Ewb** — Entering Wet Bulb
- kW** — Compressor Motor Power Input
- RH** — Relative Humidity
- SHC** — Sensible Heat Cap. (1000 Btu/h)
- TC** — Total Cap. (1000 Btu/h) Gross

3. Correction Factor = 1.10 x (1 - BF) x (edb - 75).
4. Cooling capacities are gross and do not include deduction for indoor fan motor heat.
5. Capacity table includes impact of outdoor fan staging at temperatures below 75 F.
6. SHC values provided reflect maximum reheat values with 100% gas bypass. Negative SHC value indicates that the air entering the coil is being heated at 100% gas bypass. The P Series innovative modulating valve system will reduce the gas bypass as required to meet the supply air setpoint with minimal change in latent capacity. The space will NOT be overheated and the unit will provide variable SHC to meet the space load.

NOTES:

1. The SHC is based on 75 F edb temperature of air entering evaporator coil. For edb temperatures other than 75 F, adjust SHC by multiplying the correction factor and the cfm and then adding or subtracting the value from the SHC.
2. Interpolation is permissible.

Performance data (cont)



COOLING CAPACITIES (cont)

48/50P2,P3,P4,P5040 (40 TON) HIGH-CAPACITY COIL — STANDARD MODE

Temp (F) Air Entering Condenser (Edb)	Evaporator Air Quantity — Cfm																				
	8,000					10,000					12,000					14,000					
	Evaporator Air — Ewb (F)																				
	75	72	67	62	57	75	72	67	62	57	75	72	67	62	57	75	72	67	62	57	
75	TC	502	480	439	404	369	531	504	464	427	395	550	523	480	443	417	565	537	493	456	436
	SHC	207	227	273	315	352	217	249	301	353	389	228	266	326	387	417	239	282	349	417	436
	KW	25.5	25.0	24.2	23.5	23.1	26.1	25.5	24.6	24.0	23.5	26.4	25.9	25.0	24.2	23.8	26.7	26.1	25.2	24.5	24.2
	BF	0.00	0.00	0.15	0.11	0.12	0.00	0.22	0.14	0.12	0.18	0.15	0.19	0.15	0.13	0.25	0.12	0.18	0.16	0.16	0.33
85	TC	490	469	432	397	360	518	493	456	419	386	536	511	472	435	410	551	523	484	447	429
	SHC	202	224	270	312	346	211	245	297	349	382	223	262	322	383	410	235	277	346	412	429
	KW	28.0	27.6	26.9	26.4	26.1	28.6	28.1	27.3	26.8	26.3	29.0	28.4	27.6	27.0	26.7	29.3	28.6	27.9	27.3	27.0
	BF	0.00	0.00	0.15	0.11	0.12	0.00	0.21	0.14	0.12	0.19	0.13	0.18	0.15	0.13	0.27	0.26	0.17	0.16	0.16	0.34
95	TC	480	461	423	387	350	507	484	445	408	375	526	501	461	423	400	539	514	472	434	419
	SHC	197	221	265	307	339	208	242	293	344	375	220	258	318	377	400	231	273	341	404	419
	KW	31.1	30.7	30.3	30.0	29.9	31.7	31.2	30.6	30.3	30.1	32.1	31.6	31.0	30.6	30.3	32.4	31.9	31.2	30.8	30.6
	BF	0.00	0.00	0.15	0.11	0.13	0.00	0.20	0.14	0.12	0.19	0.12	0.17	0.15	0.13	0.28	0.24	0.18	0.16	0.16	0.36
105	TC	470	448	409	372	336	495	471	431	393	363	512	485	445	406	387	524	498	455	416	406
	SHC	193	217	259	300	329	203	237	287	337	363	216	253	312	369	387	226	267	336	393	406
	KW	34.8	34.6	34.5	34.5	35.7	35.5	35.2	34.8	34.7	35.0	36.0	35.5	35.1	35.0	35.0	36.4	36.0	35.2	35.2	35.1
	BF	0.00	0.12	0.14	0.10	0.14	0.00	0.18	0.13	0.11	0.22	0.11	0.16	0.14	0.13	0.31	0.22	0.18	0.15	0.17	0.38
115	TC	454	431	392	355	319	478	452	412	373	349	491	466	425	386	372	502	476	433	397	390
	SHC	186	211	252	291	318	198	230	279	328	349	209	245	304	358	372	219	260	328	378	390
	KW	39.5	39.6	40.1	41.4	44.0	40.4	40.1	40.3	41.3	42.6	40.8	40.6	40.5	41.8	41.8	41.3	41.0	40.5	41.7	40.9
	BF	0.00	0.09	0.13	0.10	0.15	0.14	0.16	0.13	0.11	0.25	0.23	0.16	0.14	0.14	0.34	0.21	0.17	0.14	0.20	0.40

48/50P2,P3,P4,P5040 (40 TON) HIGH-CAPACITY COIL — STANDARD MODE (cont)

Temp (F) Air Entering Condenser (Edb)	Evaporator Air Quantity — Cfm															
	16,000					18,000					20,000					
	Evaporator Air — Ewb (F)															
	75	72	67	62	57	75	72	67	62	57	75	72	67	62	57	
75	TC	577	548	503	463	453	585	556	511	474	466	593	563	517	481	479
	SHC	250	296	372	438	453	259	309	393	458	466	268	322	413	475	479
	KW	27.0	26.4	25.4	24.7	24.5	27.2	26.5	25.6	24.9	24.7	27.3	26.7	25.7	25.0	25.0
	BF	0.24	0.19	0.17	0.19	0.39	0.23	0.21	0.19	0.23	0.44	0.23	0.22	0.20	0.27	0.49
85	TC	563	536	493	455	446	571	544	501	465	459	579	551	507	472	471
	SHC	245	291	368	433	446	255	304	389	452	459	264	317	410	472	471
	KW	29.5	29.0	28.1	27.4	27.3	29.7	29.1	28.3	27.7	27.5	29.9	29.3	28.4	27.7	27.7
	BF	0.23	0.20	0.17	0.20	0.40	0.22	0.21	0.19	0.24	0.45	0.22	0.22	0.20	0.27	0.49
95	TC	550	524	481	444	436	559	532	487	453	449	566	538	494	461	461
	SHC	241	287	363	421	436	251	300	388	441	449	260	313	404	461	461
	KW	32.7	32.2	31.4	31.0	30.8	32.9	32.4	31.4	31.1	31.0	33.1	32.5	31.7	31.2	31.2
	BF	0.22	0.19	0.17	0.22	0.42	0.22	0.20	0.16	0.26	0.46	0.22	0.21	0.20	0.29	0.51
105	TC	533	507	462	427	422	541	514	470	437	435	547	520	476	447	446
	SHC	236	281	360	414	422	245	294	380	431	435	254	307	396	446	446
	KW	36.7	36.3	35.3	35.4	35.0	37.0	36.5	35.6	35.2	35.3	37.2	36.6	35.9	35.5	35.5
	BF	0.21	0.19	0.15	0.22	0.43	0.21	0.20	0.17	0.27	0.48	0.21	0.21	0.20	0.31	0.52
115	TC	511	484	441	407	405	517	491	447	418	417	523	496	452	428	428
	SHC	229	273	350	401	405	238	286	371	416	417	245	299	392	428	428
	KW	41.8	41.4	40.7	41.6	41.4	42.1	41.6	41.0	41.2	41.3	42.7	41.8	41.0	41.3	41.3
	BF	0.20	0.19	0.16	0.23	0.46	0.20	0.20	0.17	0.29	0.50	0.22	0.21	0.18	0.34	0.54

LEGEND

48/50P3,P5 units only.

BF — Bypass Factor KW — Compressor Motor Power Input
 Edb — Entering Dry Bulb SHC — Sensible Heat Cap. (1000 Btuh)
 Ewb — Entering Wet Bulb TC — Total Cap. (1000 Btuh) Gross

NOTES:

- Direct interpolation is permissible. Do not extrapolate.
- The following formulas may be used:

$$t_{db} = t_{edb} - \frac{\text{sensible capacity (Btuh)}}{1.10 \times \text{cfm}}$$

$t_{w,b}$ = Wet-bulb temperature corresponding to enthalpy of air leaving evaporator coil ($h_{w,b}$).

$$h_{w,b} = h_{ew,b} - \frac{\text{total capacity (Btuh)}}{4.5 \times \text{cfm}}$$

Where: $h_{ew,b}$ = Enthalpy of air entering evaporator coil.

- SHC is based on 80 F edb temperature of air entering evaporator coil.

Below 80 F edb, subtract (corr factor x cfm) from SHC.

Above 80 F edb, add (corr factor x cfm) to SHC.

BF	ENTERING AIR DRY-BULB TEMP (F)					
	79	78	77	76	75	under 75
	81	82	83	84	85	over 85
Correction Factor						
.05	1.04	2.09	3.14	4.18	5.22	Use formula shown below
.10	0.99	1.98	2.97	3.96	4.95	
.20	0.88	1.76	2.64	3.52	4.40	

Interpolation is permissible.

Correction Factor = $1.10 \times (1 - BF) \times (edb - 80)$.

- Cooling capacities are gross and do not include deduction for indoor fan motor heat.

COOLING CAPACITIES (cont)

48/50P2,P3,P4,P5040 (40 TON) HIGH-CAPACITY COIL — SUBCOOL MODE

Temp (F) Air Entering Condenser (Edb)		Evaporator Air Quantity — Cfm																			
		8,000					10,000					12,000					14,000				
		Evaporator Air — Ewb (F)																			
		75	72	67	62	57	75	72	67	62	57	75	72	67	62	57	75	72	67	62	57
75	TC	445	418	373	335	300	479	451	403	363	337	495	467	424	385	358	518	486	440	401	382
	SHC	133	154	191	234	273	148	174	224	275	322	152	190	252	314	352	170	211	279	348	381
	kW	24.9	24.4	23.5	22.8	22.3	25.6	25.0	24.0	23.3	22.8	25.8	25.3	24.4	23.7	23.2	26.4	25.7	24.7	23.9	23.6
	BF	0.00	0.00	0.06	0.13	0.12	0.00	0.08	0.17	0.13	0.17	0.12	0.08	0.16	0.14	0.24	0.10	0.22	0.17	0.16	0.30
85	TC	414	389	347	313	279	443	416	377	340	318	466	437	398	362	339	482	453	414	378	362
	SHC	106	129	167	213	254	117	143	200	254	304	128	165	229	293	332	139	183	256	328	361
	kW	27.2	26.6	25.8	25.2	24.7	27.7	27.2	26.4	25.7	25.2	28.2	27.6	26.7	26.0	25.6	28.5	27.9	27.0	26.3	26.0
	BF	0.00	0.13	0.06	0.13	0.12	0.00	0.07	0.17	0.13	0.18	0.11	0.07	0.16	0.14	0.25	0.10	0.22	0.17	0.16	0.31
95	TC	384	361	322	290	261	412	387	351	317	299	433	407	372	338	318	449	424	388	354	339
	SHC	80	104	144	193	236	90	118	177	234	285	99	138	206	273	311	111	158	234	307	339
	kW	29.7	29.2	28.5	28.0	27.5	30.3	29.8	29.1	28.5	28.2	30.8	30.2	29.5	28.9	28.5	31.1	30.5	29.8	29.1	28.8
	BF	0.00	0.10	0.05	0.13	0.14	0.00	0.07	0.17	0.13	0.19	0.10	0.07	0.16	0.14	0.26	0.09	0.22	0.17	0.17	0.30
105	TC	355	333	295	265	239	380	356	323	292	279	401	376	343	312	300	416	393	358	331	318
	SHC	53	80	121	172	217	63	92	154	213	266	72	112	183	251	293	84	132	210	284	317
	kW	32.7	32.3	31.7	31.3	31.0	33.3	32.8	32.3	31.8	31.6	33.8	33.3	32.7	32.2	31.9	34.1	33.6	33.0	32.4	32.2
	BF	0.00	0.09	0.05	0.13	0.13	0.15	0.07	0.16	0.13	0.20	0.09	0.07	0.16	0.14	0.25	0.09	0.21	0.17	0.18	0.31
115	TC	324	303	266	239	220	346	323	294	264	259	365	343	313	284	276	381	358	329	300	295
	SHC	27	56	99	151	199	35	65	131	192	248	44	85	159	229	269	56	105	187	255	295
	kW	36.2	35.9	35.4	35.4	35.5	36.8	36.4	36.0	36.0	35.9	37.3	36.9	36.5	36.3	36.1	37.7	37.3	36.8	36.4	36.3
	BF	0.00	0.08	0.05	0.12	0.15	0.11	0.06	0.16	0.13	0.21	0.09	0.07	0.16	0.15	0.27	0.08	0.21	0.17	0.18	0.34

48/50P2,P3,P4,P5040 (40 TON) HIGH-CAPACITY COIL — SUBCOOL MODE (cont)

Temp (F) Air Entering Condenser (Edb)		Evaporator Air Quantity — Cfm														
		16,000					18,000					20,000				
		Evaporator Air — Ewb (F)														
		75	72	67	62	57	75	72	67	62	57	75	72	67	62	57
75	TC	523	498	452	414	399	540	508	462	426	413	549	516	471	428	419
	SHC	176	227	304	377	399	194	243	327	394	413	205	257	350	406	419
	kW	26.4	25.9	24.9	24.2	23.9	26.8	26.1	25.1	24.4	24.2	27.0	26.3	25.3	24.5	24.3
	BF	0.10	0.21	0.18	0.19	0.36	0.28	0.22	0.19	0.23	0.40	0.26	0.22	0.20	0.26	0.46
85	TC	493	466	426	393	378	504	477	435	407	396	513	485	444	419	405
	SHC	152	200	281	356	378	164	217	304	379	396	174	232	327	400	405
	kW	28.7	28.1	27.3	26.6	26.3	29.0	28.3	27.5	26.8	26.6	29.1	28.5	27.6	27.1	26.8
	BF	0.09	0.21	0.18	0.20	0.37	0.27	0.22	0.19	0.24	0.42	0.26	0.22	0.20	0.28	0.45
95	TC	462	439	400	370	357	473	449	409	384	370	480	454	417	398	382
	SHC	125	177	259	333	357	138	192	282	357	370	146	205	305	380	382
	kW	31.4	30.8	30.0	29.4	29.1	31.6	31.0	30.2	29.7	29.4	31.7	31.2	30.4	29.9	29.6
	BF	0.09	0.21	0.18	0.21	0.38	0.27	0.22	0.19	0.25	0.43	0.26	0.22	0.20	0.28	0.46
105	TC	428	408	371	346	335	439	417	380	361	348	449	422	388	377	361
	SHC	97	151	235	311	335	110	167	259	335	348	122	179	281	360	361
	kW	34.4	34.0	33.3	32.7	32.5	34.7	34.2	33.5	33.0	32.8	34.9	34.3	33.6	33.4	33.0
	BF	0.09	0.21	0.18	0.22	0.39	0.26	0.21	0.19	0.26	0.44	0.26	0.22	0.20	0.29	0.48
115	TC	393	374	338	322	310	403	385	347	335	324	412	390	354	347	334
	SHC	70	126	210	288	310	82	142	233	310	324	93	155	255	327	334
	kW	38.1	37.6	37.0	36.7	36.5	38.4	37.9	37.3	36.9	36.7	38.6	38.1	37.5	37.2	36.9
	BF	0.08	0.21	0.18	0.23	0.40	0.27	0.21	0.19	0.27	0.45	0.25	0.22	0.20	0.29	0.49

LEGEND

48/50P3,P5 units only.

BF — Bypass Factor **kW** — Compressor Motor Power Input
Edb — Entering Dry Bulb **SHC** — Sensible Heat Cap. (1000 Btu/h)
Ewb — Entering Wet Bulb **TC** — Total Cap. (1000 Btu/h) Gross

NOTES:

- The SHC is based on 80 F edb temperature of air entering evaporator coil. For edb temperatures other than 80 F, adjust SHC by multiplying the correction factor and the cfm and then adding or subtracting the value from the SHC.

- Interpolation is permissible.
- Correction Factor = $1.10 \times (1 - BF) \times (edb - 80)$.
- Cooling capacities are gross and do not include deduction for indoor fan motor heat.
- SHC values provided are in subcooling mode with the gas bypass valve closed and reflect the maximum SHC in subcooling mode. The P Series innovative modulating valve system can reduce SHC as needed to meet the supply air set point requirement with minimal change in latent capacity. This will provide variable SHC to meet the space load.

Performance data (cont)



COOLING CAPACITIES (cont)

48/50P2,P3,P4,P5040 (40 TON) HIGH-CAPACITY COIL — HOT GAS REHEAT MODE

Temp (F) Air Ent Condenser (Edb)		Air Entering Evaporator — Ewb (F)													
		75 Dry Bulb 62.5 Wet Bulb (50% RH)							75 Dry Bulb 65.3 Wet Bulb (60% RH)						
		Air Entering Evaporator — Cfm													
		8000	10,000	12,000	14,000	16,000	18,000	20,000	8000	10,000	12,000	14,000	16,000	18,000	20,000
80	TC	157	168	176	181	186	189	192	165	177	185	191	196	199	202
	SHC	11	25	40	56	72	88	104	-25	-15	-5	5	17	28	40
	kW	24.6	24.8	24.9	25.1	25.2	25.3	25.4	25.5	25.6	25.7	25.9	26.0	26.1	26.1
	BF	0.22	0.16	0.16	0.17	0.18	0.19	0.20	0.08	0.07	0.19	0.19	0.20	0.20	0.21
75	TC	158	169	177	183	187	191	194	167	179	187	193	197	201	204
	SHC	12	26	41	57	73	89	105	-23	-14	-4	7	18	30	42
	kW	24.0	24.2	24.3	24.5	24.6	24.7	24.8	24.9	25.0	25.2	25.3	25.4	25.5	25.6
	BF	0.22	0.16	0.16	0.17	0.18	0.19	0.20	0.08	0.07	0.19	0.19	0.20	0.20	0.21
70	TC	156	167	175	180	184	189	191	165	176	184	190	195	198	200
	SHC	11	26	41	56	72	90	105	-23	-14	-4	6	18	29	42
	kW	24.8	25.0	25.3	25.4	25.6	25.7	25.8	25.7	26.0	26.2	26.3	26.5	26.6	26.7
	BF	0.21	0.16	0.16	0.17	0.18	0.19	0.20	0.08	0.23	0.19	0.19	0.19	0.20	0.21
60	TC	160	171	178	184	188	192	195	168	180	188	194	198	202	204
	SHC	14	28	43	59	75	92	108	-20	-11	-2	9	20	32	44
	kW	23.6	23.9	24.1	24.3	24.4	24.6	24.7	24.6	24.8	25.0	25.2	25.4	25.5	25.6
	BF	0.20	0.16	0.16	0.17	0.18	0.19	0.20	0.08	0.22	0.19	0.19	0.19	0.20	0.21
50	TC	163	175	183	189	193	196	199	172	184	193	199	203	207	210
	SHC	17	31	46	62	78	94	111	-18	-8	1	12	24	36	48
	kW	22.7	23.0	23.2	23.4	23.6	23.7	23.8	23.7	24.0	24.2	24.3	24.5	24.6	24.7
	BF	0.20	0.16	0.16	0.17	0.18	0.19	0.20	0.09	0.22	0.19	0.19	0.19	0.20	0.21
40	TC	165	178	186	192	197	200	204	174	187	196	202	207	211	214
	SHC	19	33	49	65	81	97	114	-16	-6	4	15	26	38	51
	kW	22.0	22.3	22.5	22.7	22.9	23.0	23.1	23.0	23.2	23.4	23.6	23.8	23.9	24.0
	BF	0.20	0.16	0.16	0.17	0.18	0.19	0.20	0.09	0.21	0.19	0.19	0.19	0.20	0.21

48/50P2,P3,P4,P5040 (40 TON) HIGH-CAPACITY COIL — HOT GAS REHEAT MODE (cont)

Temp (F) Air Ent Condenser (Edb)		Air Entering Evaporator — Ewb (F)													
		75 Dry Bulb 68 Wet Bulb (70% RH)							75 Dry Bulb 70.5 Wet Bulb (80% RH)						
		Air Entering Evaporator — Cfm													
		8000	10,000	12,000	14,000	16,000	18,000	20,000	8000	10,000	12,000	14,000	16,000	18,000	20,000
80	TC	174	186	195	201	206	209	212	182	195	204	210	215	219	223
	SHC	-55	-56	-50	-43	-36	-29	-21	-83	-89	-92	-92	-86	-82	-78
	kW	26.4	26.5	26.6	26.7	26.8	26.9	27.0	27.2	27.4	27.5	27.6	27.6	27.7	27.8
	BF	0.00	0.09	0.08	0.24	0.22	0.23	0.23	0.00	0.00	0.00	0.12	0.10	0.31	0.28
75	TC	176	188	197	203	208	211	215	185	198	207	213	218	222	225
	SHC	-54	-55	-48	-41	-34	-27	-19	-81	-88	-90	-90	-84	-80	-76
	kW	25.8	26.0	26.1	26.2	26.3	26.4	26.4	26.6	26.8	27.0	27.1	27.1	27.2	27.3
	BF	0.00	0.10	0.08	0.24	0.22	0.23	0.23	0.00	0.00	0.00	0.12	0.11	0.31	0.27
70	TC	173	185	193	200	204	208	211	180	193	202	208	213	218	222
	SHC	-54	-55	-48	-42	-35	-28	-20	-82	-88	-90	-91	-85	-81	-77
	kW	26.7	26.9	27.1	27.2	27.4	27.5	27.6	27.6	27.8	28.0	28.2	28.3	28.4	28.5
	BF	0.00	0.09	0.08	0.23	0.22	0.23	0.23	0.00	0.00	0.00	0.12	0.10	0.29	0.27
60	TC	177	189	197	204	208	212	215	186	199	207	213	218	222	225
	SHC	-52	-52	-45	-39	-31	-25	-17	-78	-85	-87	-86	-82	-78	-73
	kW	25.6	25.9	26.0	26.2	26.3	26.4	26.5	26.5	26.8	27.0	27.1	27.2	27.3	27.4
	BF	0.00	0.10	0.08	0.23	0.22	0.22	0.23	0.00	0.00	0.00	0.12	0.11	0.29	0.27
50	TC	181	194	202	209	214	218	221	188	203	212	219	224	228	231
	SHC	-52	-49	-42	-36	-29	-21	-13	-76	-82	-84	-83	-78	-74	-70
	kW	24.8	25.0	25.1	25.3	25.4	25.5	25.6	25.6	25.9	26.1	26.2	26.3	26.4	26.5
	BF	0.00	0.11	0.09	0.23	0.22	0.23	0.23	0.00	0.00	0.00	0.13	0.11	0.29	0.27
40	TC	183	197	206	213	218	222	225	192	206	216	223	228	233	236
	SHC	-52	-47	-40	-33	-26	-18	-10	-73	-80	-81	-80	-75	-71	-67
	kW	24.1	24.3	24.4	24.6	24.7	24.8	24.9	24.8	25.2	25.4	25.5	25.6	25.7	25.8
	BF	0.00	0.12	0.09	0.23	0.22	0.23	0.23	0.00	0.00	0.00	0.14	0.12	0.29	0.27

LEGEND

- BF** — Bypass Factor
- Edb** — Entering Dry Bulb
- Ewb** — Entering Wet Bulb
- kW** — Compressor Motor Power Input
- RH** — Relative Humidity
- SHC** — Sensible Heat Cap. (1000 Btu/h)
- TC** — Total Cap. (1000 Btu/h) Gross

6. SHC values provided reflect maximum reheat values with 100% gas bypass. Negative SHC value indicates that the air entering the coil is being heated at 100% gas bypass. The P Series innovative modulating valve system will reduce the gas bypass as required to meet the supply air setpoint with minimal change in latent capacity. The space will NOT be overheated and the unit will provide variable SHC to meet the space load.

NOTES:

1. The SHC is based on 75 F edb temperature of air entering evaporator coil. For edb temperatures other than 75 F, adjust SHC by multiplying the correction factor and the cfm and then adding or subtracting the value from the SHC.
2. Interpolation is permissible.
3. Correction Factor = $1.10 \times (1 - BF) \times (edb - 75)$.
4. Cooling capacities are gross and do not include deduction for indoor fan motor heat.
5. Capacity table includes impact of outdoor fan staging at temperatures below 75 F.

COOLING CAPACITIES (cont)

48/50P2,P3,P4,P5050 (50 TON) STANDARD CAPACITY COIL — STANDARD MODE

Temp (F) Air Entering Condenser (Edb)		Evaporator Air Quantity — Cfm																			
		10,000					12,500					15,000					17,500				
		Evaporator Air — Ewb (F)																			
		75	72	67	62	57	75	72	67	62	57	75	72	67	62	57	75	72	67	62	57
75	TC	633	606	558	512	466	665	635	587	541	494	690	656	607	561	520	707	672	622	576	541
	SHC	260	281	338	389	436	273	303	369	431	480	277	323	398	470	518	288	341	423	506	541
	KW	33.8	33.3	32.5	32.1	31.9	34.3	33.8	33.0	32.5	32.2	34.7	34.2	33.3	32.8	32.4	35.0	34.4	33.6	33.0	32.6
	BF	0.00	0.00	0.09	0.18	0.15	0.00	0.00	0.23	0.19	0.21	0.00	0.13	0.23	0.20	0.28	0.00	0.30	0.24	0.21	0.33
85	TC	614	592	543	495	450	646	618	571	523	477	667	637	590	542	501	681	650	605	557	526
	SHC	251	273	331	381	427	257	297	363	423	461	268	316	391	461	500	282	333	417	497	526
	KW	37.4	37.0	36.4	36.2	36.0	38.0	37.5	36.8	36.5	36.0	38.4	37.8	37.1	36.7	36.5	38.7	38.1	37.4	36.9	36.7
	BF	0.00	0.00	0.26	0.17	0.15	0.00	0.00	0.22	0.18	0.24	0.00	0.32	0.22	0.20	0.29	0.20	0.28	0.23	0.21	0.35
95	TC	598	573	525	476	428	628	600	551	502	458	646	618	570	520	484	658	632	583	534	508
	SHC	245	268	323	371	413	251	291	355	413	458	262	310	383	452	484	275	327	408	487	508
	KW	41.8	41.4	41.2	41.1	41.2	42.4	42.0	41.5	41.4	41.3	42.7	42.3	41.8	41.6	41.4	43.0	42.6	42.1	41.8	41.7
	BF	0.00	0.00	0.23	0.16	0.16	0.00	0.14	0.21	0.18	0.24	0.00	0.29	0.21	0.19	0.31	0.17	0.27	0.23	0.21	0.38
105	TC	578	552	502	454	408	606	577	527	478	436	623	594	544	495	465	635	608	557	508	488
	SHC	237	261	314	360	398	243	283	345	402	436	256	302	372	441	465	268	319	398	474	488
	KW	47.1	46.9	46.8	47.2	48.7	47.6	47.4	47.2	47.3	48.2	47.9	47.6	47.5	47.3	47.8	48.1	47.9	47.7	47.5	47.6
	BF	0.00	0.00	0.20	0.16	0.17	0.00	0.12	0.20	0.17	0.25	0.00	0.27	0.21	0.19	0.33	0.14	0.26	0.22	0.22	0.40
115	TC	553	526	477	429	382	580	549	500	451	416	595	566	516	467	443	607	578	528	479	466
	SHC	227	253	303	349	379	234	273	334	390	416	248	292	361	428	443	259	309	387	455	466
	KW	53.2	53.3	53.8	55.5	58.0	53.7	53.6	53.9	55.3	56.9	53.9	53.9	54.1	55.3	56.0	54.1	54.1	54.1	55.0	55.5
	BF	0.00	0.00	0.18	0.15	0.20	0.00	0.27	0.19	0.17	0.28	0.16	0.25	0.20	0.19	0.36	0.33	0.24	0.22	0.23	0.43

48/50P2,P3,P4,P5050 (50 TON) STANDARD CAPACITY COIL — STANDARD MODE (cont)

Temp (F) Air Entering Condenser (Edb)		Evaporator Air Quantity — Cfm				
		20,000				
		Evaporator Air — Ewb (F)				
		75	72	67	62	57
75	TC	719	685	633	587	562
	SHC	301	357	448	539	562
	KW	35.2	34.7	33.8	33.2	32.9
	BF	0.17	0.29	0.25	0.23	0.40
85	TC	693	662	616	568	547
	SHC	293	350	441	529	547
	KW	38.9	38.3	37.6	37.1	36.9
	BF	0.15	0.28	0.24	0.24	0.41
95	TC	668	643	594	543	528
	SHC	286	343	433	515	528
	KW	43.2	42.8	42.2	41.9	41.8
	BF	0.35	0.27	0.24	0.24	0.43
105	TC	645	618	568	519	507
	SHC	279	335	423	498	507
	KW	48.3	48.1	47.8	47.5	47.5
	BF	0.32	0.26	0.24	0.26	0.45
115	TC	615	587	537	491	484
	SHC	270	325	412	480	484
	KW	54.2	54.3	54.1	55.0	55.1
	BF	0.30	0.25	0.23	0.28	0.48

LEGEND

48/50P3,P5 units only.

BF — Bypass Factor **KW** — Compressor Motor Power Input
Edb — Entering Dry Bulb **SHC** — Sensible Heat Cap. (1000 Btuh)
Ewb — Entering Wet Bulb **TC** — Total Cap. (1000 Btuh) Gross

NOTES:

- Direct interpolation is permissible. Do not extrapolate.
- The following formulas may be used:

$$t_{db} = t_{edb} - \frac{\text{sensible capacity (Btuh)}}{1.10 \times \text{cfm}}$$

$$t_{wb} = \text{Wet-bulb temperature corresponding to enthalpy of air leaving evaporator coil } (h_{wb}).$$

$$h_{wb} = h_{ewb} - \frac{\text{total capacity (Btuh)}}{4.5 \times \text{cfm}}$$

Where: h_{ewb} = Enthalpy of air entering evaporator coil.

- SHC is based on 80 F edb temperature of air entering evaporator coil.
Below 80 F edb, subtract (corr factor x cfm) from SHC.
Above 80 F edb, add (corr factor x cfm) to SHC.

BF	ENTERING AIR DRY-BULB TEMP (F)					
	79	78	77	76	75	under 75
	81	82	83	84	85	over 85
Correction Factor						
.05	1.04	2.09	3.14	4.18	5.22	Use formula shown below
.10	0.99	1.98	2.97	3.96	4.95	
.20	0.88	1.76	2.64	3.52	4.40	

Interpolation is permissible.
Correction Factor = $1.10 \times (1 - BF) \times (edb - 80)$.

- Cooling capacities are gross and do not include deduction for indoor fan motor heat.

Performance data (cont)



COOLING CAPACITIES (cont)

48/50P2,P3,P4,P5050 (50 TON) STANDARD CAPACITY COIL — SUBCOOL MODE

Temp (F) Air Entering Condenser (Edb)		Evaporator Air Quantity — Cfm																			
		10,000					12,500					15,000					17,500				
		Evaporator Air — Ewb (F)																			
		75	72	67	62	57	75	72	67	62	57	75	72	67	62	57	75	72	67	62	57
75	TC	590	563	519	472	450	625	598	549	502	465	652	619	571	524	491	671	638	588	551	513
	SHC	206	233	275	329	413	219	248	308	370	450	228	256	336	406	480	235	281	362	473	513
	KW	33.2	32.7	32.1	31.5	31.8	33.8	33.3	32.5	31.9	31.4	34.2	33.7	32.9	32.3	31.6	34.5	34.0	33.2	32.5	32.0
	BF	0.02	0.00	0.13	0.08	0.13	0.00	0.00	0.11	0.28	0.18	0.00	0.16	0.35	0.28	0.25	0.00	0.14	0.33	0.20	0.32
85	TC	565	538	493	450	429	598	572	525	479	445	620	590	545	500	467	638	610	562	513	492
	SHC	184	213	256	312	397	194	228	290	353	431	206	234	317	388	467	212	260	343	420	492
	KW	36.7	36.2	35.6	35.2	35.5	37.3	36.8	36.1	35.6	35.0	37.7	37.2	36.5	35.9	35.4	38.0	37.5	36.8	36.2	35.8
	BF	0.00	0.00	0.11	0.08	0.14	0.00	0.00	0.10	0.27	0.19	0.00	0.15	0.34	0.28	0.26	0.00	0.13	0.32	0.29	0.34
95	TC	538	513	466	424	407	568	544	498	451	436	593	563	517	473	444	607	581	533	487	467
	SHC	163	195	236	293	380	172	208	270	332	424	177	215	296	369	444	189	238	322	402	467
	KW	40.8	40.4	39.9	39.5	40.4	41.4	41.0	40.4	39.9	40.6	41.9	41.4	40.8	40.3	39.9	42.2	41.7	41.1	40.5	40.1
	BF	0.00	0.00	0.10	0.28	0.14	0.00	0.00	0.10	0.26	0.21	0.00	0.13	0.33	0.27	0.27	0.00	0.13	0.32	0.29	0.35
105	TC	507	483	439	398	383	537	511	469	423	398	559	533	486	445	420	572	547	502	458	442
	SHC	140	174	216	274	360	148	177	250	311	388	154	196	275	350	420	164	215	301	382	442
	KW	45.6	45.3	44.9	45.0	46.4	46.2	45.9	45.4	45.3	45.3	46.7	46.3	45.8	45.5	45.5	46.9	46.6	46.1	45.8	45.6
	BF	0.00	0.00	0.09	0.26	0.15	0.00	0.15	0.09	0.26	0.22	0.00	0.13	0.33	0.27	0.29	0.17	0.12	0.31	0.29	0.36
115	TC	474	454	429	399	343	501	477	454	408	375	521	497	470	424	394	534	510	483	434	415
	SHC	116	145	224	294	321	124	155	253	320	366	129	173	280	357	394	138	191	305	388	415
	KW	51.1	51.0	51.3	52.7	52.2	51.7	51.5	51.6	52.1	52.3	52.1	51.9	51.9	52.1	52.3	52.4	52.2	52.0	52.1	52.2
	BF	0.00	0.00	0.15	0.13	0.18	0.00	0.13	0.17	0.16	0.24	0.00	0.12	0.19	0.18	0.31	0.15	0.12	0.21	0.21	0.38

48/50P2,P3,P4,P5050 (50 TON) STANDARD CAPACITY COIL — SUBCOOL MODE (cont)

Temp (F) Air Entering Condenser (Edb)		Evaporator Air Quantity — Cfm				
		20,000				
		Evaporator Air — Ewb (F)				
		75	72	67	62	57
75	TC	684	650	599	562	531
	SHC	241	296	383	503	531
	KW	34.8	34.2	33.4	32.7	32.3
	BF	0.22	0.14	0.33	0.22	0.37
85	TC	650	621	573	536	508
	SHC	217	274	363	483	508
	KW	38.3	37.7	36.9	36.3	36.0
	BF	0.18	0.13	0.32	0.22	0.39
95	TC	618	591	543	497	484
	SHC	194	251	342	427	484
	KW	42.4	41.9	41.3	40.7	40.4
	BF	0.17	0.13	0.32	0.30	0.40
105	TC	583	557	511	492	458
	SHC	169	228	320	447	458
	KW	47.2	46.8	46.2	46.2	45.6
	BF	0.16	0.12	0.32	0.25	0.41
115	TC	544	519	492	448	430
	SHC	142	203	326	406	430
	KW	52.6	52.3	52.1	51.9	52.1
	BF	0.14	0.12	0.22	0.26	0.43

LEGEND

48/50P3,P5 units only.

BF — Bypass Factor **KW** — Compressor Motor Power Input
Edb — Entering Dry Bulb **SHC** — Sensible Heat Cap. (1000 Btu/h)
Ewb — Entering Wet Bulb **TC** — Total Cap. (1000 Btu/h) Gross

NOTES:

- The SHC is based on 80 F edb temperature of air entering evaporator coil. For edb temperatures other than 80 F, adjust SHC by multiplying the correction factor and the cfm and then adding or subtracting the value from the SHC.

- Interpolation is permissible.
- Correction Factor = $1.10 \times (1 - BF) \times (edb - 80)$.
- Cooling capacities are gross and do not include deduction for indoor fan motor heat.
- SHC values provided are in subcooling mode with the gas bypass valve closed and reflect the maximum SHC in subcooling mode. The P Series innovative modulating valve system can reduce SHC as needed to meet the supply air set point requirement with minimal change in latent capacity. This will provide variable SHC to meet the space load.

COOLING CAPACITIES (cont)

48/50P2,P3,P4,P5050 (50 TON) STANDARD CAPACITY COIL — HOT GAS REHEAT MODE

Temp (F) Air Ent Condenser (Edb)		Air Entering Evaporator — Ewb (F)									
		75 Dry Bulb 62.5 Wet Bulb (50% RH)					75 Dry Bulb 65.3 Wet Bulb (60% RH)				
		Air Entering Evaporator — Cfm									
		10,000	12,500	15,000	17,500	20,000	10,000	12,500	15,000	17,500	20,000
80	TC	192	207	217	224	230	205	220	231	239	245
	SHC	-4	11	27	43	59	-42	-38	-25	-13	-1
	kW	35.7	36.0	36.0	36.4	36.4	36.8	36.8	36.6	36.6	36.7
	BF	0.12	0.10	0.35	0.33	0.33	0.00	0.15	0.13	0.12	0.37
75	TC	197	211	222	229	235	209	225	235	243	250
	SHC	-1	14	30	45	62	-39	-35	-23	-11	1
	kW	34.5	34.9	34.8	35.2	35.2	35.6	35.5	35.5	35.5	35.6
	BF	0.13	0.11	0.35	0.33	0.33	0.00	0.16	0.13	0.12	0.37
70	TC	197	211	222	229	234	208	223	234	242	248
	SHC	-1	14	30	45	62	-39	-36	-23	-11	1
	kW	35.0	35.3	35.4	35.7	35.8	36.1	36.2	36.1	36.2	36.3
	BF	0.13	0.11	0.35	0.33	0.33	0.00	0.16	0.13	0.12	0.37
60	TC	205	219	229	237	243	215	230	241	249	255
	SHC	3	18	34	50	65	-35	-32	-19	-7	5
	kW	33.0	33.3	33.3	33.6	33.7	34.1	34.2	34.2	34.3	34.4
	BF	0.15	0.11	0.35	0.33	0.33	0.00	0.00	0.13	0.13	0.37
50	TC	209	224	234	242	248	219	235	245	253	260
	SHC	6	21	37	53	68	-38	-29	-17	-5	7
	kW	31.6	31.9	31.9	32.1	32.3	32.7	32.8	32.9	33.0	33.1
	BF	0.17	0.11	0.35	0.33	0.33	0.00	0.00	0.14	0.13	0.37
40	TC	213	227	238	246	252	225	240	251	259	266
	SHC	8	24	39	55	70	-36	-26	-14	-2	10
	kW	30.9	31.0	31.1	31.3	31.4	32.0	32.0	32.0	32.1	32.2
	BF	0.00	0.12	0.35	0.33	0.33	0.00	0.00	0.14	0.13	0.37

48/50P2,P3,P4,P5050 (50 TON) STANDARD CAPACITY COIL — HOT GAS REHEAT MODE (cont)

Temp (F) Air Ent Condenser (Edb)		Air Entering Evaporator — Ewb (F)									
		75 Dry Bulb 62.5 Wet Bulb (50% RH)					75 Dry Bulb 65.3 Wet Bulb (60% RH)				
		Air Entering Evaporator — Cfm									
		10,000	12,500	15,000	17,500	20,000	10,000	12,500	15,000	17,500	20,000
80	TC	218	233	244	252	258	227	244	256	264	270
	SHC	-72	-79	-77	-71	-62	-102	-108	-111	-119	-116
	kW	37.2	37.3	37.2	37.3	37.3	37.7	37.7	37.9	37.9	37.8
	BF	0.00	0.00	0.00	0.16	0.14	0.00	0.00	0.00	0.00	0.00
75	TC	222	237	248	256	262	231	247	260	268	274
	SHC	-70	-77	-75	-69	-61	-100	-106	-109	-118	-114
	kW	36.1	36.2	36.2	36.2	36.2	36.7	36.7	36.7	36.9	36.9
	BF	0.00	0.00	0.00	0.16	0.15	0.00	0.00	0.00	0.00	0.00
70	TC	220	236	247	254	260	229	246	257	265	271
	SHC	-70	-76	-78	-69	-61	-100	-106	-109	-118	-114
	kW	36.7	36.6	36.8	37.0	37.1	37.3	37.4	37.6	37.8	37.9
	BF	0.00	0.00	0.00	0.16	0.15	0.03	0.00	0.00	0.00	0.00
60	TC	225	241	253	261	267	235	251	264	272	278
	SHC	-62	-73	-75	-66	-58	-96	-103	-106	-115	-111
	kW	34.7	35.0	35.1	35.2	35.3	35.5	35.7	35.8	36.1	36.1
	BF	0.00	0.00	0.00	0.17	0.15	0.02	0.00	0.00	0.00	0.00
50	TC	230	248	259	267	273	241	258	272	281	287
	SHC	-59	-71	-70	-63	-54	-93	-99	-103	-112	-107
	kW	33.3	33.7	33.8	33.9	34.0	34.2	34.4	34.6	34.8	34.8
	BF	0.00	0.00	0.00	0.18	0.16	0.01	0.00	0.00	0.00	0.00
40	TC	235	254	264	273	279	246	264	277	286	293
	SHC	-56	-68	-68	-60	-51	-91	-96	-100	-108	-109
	kW	32.5	32.8	33.0	33.0	33.0	33.4	33.5	33.6	33.8	33.9
	BF	0.00	0.00	0.00	0.20	0.16	0.00	0.00	0.00	0.00	0.00

LEGEND

BF — Bypass Factor **RH** — Relative Humidity
Edb — Entering Dry Bulb **SHC** — Sensible Heat Cap. (1000 Btu/h)
Ewb — Entering Wet Bulb **TC** — Total Cap. (1000 Btu/h) Gross
kW — Compressor Motor Power Input

NOTES:

- The SHC is based on 75 F edb temperature of air entering evaporator coil. For edb temperatures other than 75 F, adjust SHC by multiplying the correction factor and the cfm and then adding or subtracting the value from the SHC.
- Interpolation is permissible.
- Correction Factor = $1.10 \times (1 - BF) \times (edb - 75)$.
- Cooling capacities are gross and do not include deduction for indoor fan motor heat.

- Capacity table includes impact of outdoor fan staging at temperatures below 75 F.
- SHC values provided reflect maximum reheat values with 100% gas bypass. Negative SHC value indicates that the air entering the coil is being heated at 100% gas bypass. The P Series innovative modulating valve system will reduce the gas bypass as required to meet the supply air setpoint with minimal change in latent capacity. The space will NOT be overheated and the unit will provide variable SHC to meet the space load.

Performance data (cont)



COOLING CAPACITIES (cont)

48/50P2,P3,P4,P5050 (50 TON) HIGH-CAPACITY COIL — STANDARD MODE

Temp (F) Air Entering Condenser (Edb)		Evaporator Air Quantity — Cfm																			
		10,000					12,500					15,000					17,500				
		Evaporator Air — Ewb (F)																			
		75	72	67	62	57	75	72	67	62	57	75	72	67	62	57	75	72	67	62	57
75	TC	638	609	560	517	476	673	643	590	546	503	698	665	611	566	527	715	677	627	581	552
	SHC	264	289	343	397	446	274	312	376	441	490	284	332	406	481	526	298	351	434	518	552
	KW	33.7	33.3	32.4	31.7	31.3	34.3	33.8	32.9	32.2	31.6	34.8	34.2	33.3	32.5	31.9	35.1	34.5	33.5	32.8	32.3
	BF	0.00	0.00	0.20	0.14	0.13	0.00	0.13	0.19	0.15	0.18	0.00	0.25	0.19	0.17	0.25	0.16	0.22	0.20	0.18	0.32
85	TC	622	595	549	505	461	654	624	578	533	489	678	646	598	552	515	695	661	613	567	540
	SHC	256	280	338	391	437	266	305	371	435	481	277	326	400	475	515	292	345	428	511	540
	KW	37.4	36.9	36.1	35.5	35.4	38.0	37.4	36.6	36.0	35.6	38.4	37.8	37.0	36.3	35.9	38.8	38.1	37.2	36.6	36.2
	BF	0.00	0.00	0.19	0.14	0.13	0.00	0.12	0.18	0.15	0.19	0.00	0.23	0.19	0.16	0.26	0.14	0.22	0.20	0.19	0.34
95	TC	606	582	535	488	440	638	610	562	515	472	658	630	582	534	500	677	646	596	548	525
	SHC	248	277	332	383	424	257	300	364	426	465	273	320	394	466	500	287	339	421	502	525
	KW	41.6	41.3	40.7	40.5	40.4	42.3	41.9	41.3	40.9	40.5	42.7	42.3	41.6	41.3	41.0	43.2	42.7	41.9	41.6	41.2
	BF	0.00	0.00	0.18	0.13	0.13	0.00	0.11	0.17	0.15	0.22	0.00	0.23	0.18	0.16	0.28	0.31	0.21	0.19	0.19	0.36
105	TC	591	564	515	467	423	621	591	541	492	452	641	611	560	510	481	656	625	573	523	505
	SHC	242	271	323	372	407	253	294	355	416	451	267	313	384	455	481	280	331	412	488	505
	KW	46.9	46.8	46.6	46.6	47.6	47.7	47.5	47.1	46.9	47.4	48.3	48.0	47.5	47.2	47.3	48.7	48.3	47.7	47.5	47.3
	BF	0.00	0.00	0.16	0.13	0.17	0.00	0.23	0.17	0.14	0.23	0.16	0.21	0.18	0.16	0.31	0.28	0.21	0.19	0.19	0.38
115	TC	569	540	490	443	400	596	565	514	466	431	614	583	531	479	459	627	595	542	493	483
	SHC	234	262	312	360	394	244	284	344	403	431	259	304	374	442	459	271	321	402	470	483
	KW	53.4	53.5	54.2	55.9	59.3	54.2	54.1	54.4	55.9	57.2	54.9	54.6	54.7	55.7	56.4	55.4	55.1	54.6	55.8	56.0
	BF	0.00	0.12	0.15	0.12	0.17	0.00	0.21	0.16	0.14	0.26	0.13	0.20	0.17	0.16	0.34	0.25	0.21	0.18	0.20	0.41

48/50P2,P3,P4,P5050 (50 TON) HIGH-CAPACITY COIL — STANDARD MODE (cont)

Temp (F) Air Entering Condenser (Edb)		Evaporator Air Quantity — Cfm				
		20,000				
		Evaporator Air — Ewb (F)				
		75	72	67	62	57
75	TC	730	695	639	593	572
	SHC	311	368	460	549	572
	KW	35.3	34.7	33.8	33.0	32.6
	BF	0.31	0.24	0.21	0.21	0.39
85	TC	707	675	624	578	561
	SHC	305	361	454	541	561
	KW	39.0	38.4	37.5	36.8	36.5
	BF	0.28	0.23	0.21	0.22	0.40
95	TC	690	658	606	558	545
	SHC	299	356	450	524	545
	KW	43.5	42.9	42.1	41.5	41.4
	BF	0.27	0.23	0.20	0.23	0.42
105	TC	668	635	582	534	525
	SHC	292	348	440	514	525
	KW	49.1	48.6	47.8	47.7	47.4
	BF	0.25	0.22	0.20	0.23	0.44
115	TC	638	606	553	507	502
	SHC	283	337	428	496	502
	KW	55.8	55.4	55.2	56.0	55.7
	BF	0.24	0.22	0.20	0.25	0.46

LEGEND

48/50P3,P5 units only.

BF — Bypass Factor **KW** — Compressor Motor Power Input
Edb — Entering Dry Bulb **SHC** — Sensible Heat Cap. (1000 Btuh)
Ewb — Entering Wet Bulb **TC** — Total Cap. (1000 Btuh) Gross

NOTES:

- Direct interpolation is permissible. Do not extrapolate.
- The following formulas may be used:

$$t_{ldb} = t_{edb} - \frac{\text{sensible capacity (Btuh)}}{1.10 \times \text{cfm}}$$

$$t_{lwb} = \text{Wet-bulb temperature corresponding to enthalpy of air leaving evaporator coil } (h_{lwb}).$$

$$h_{lwb} = h_{ewb} - \frac{\text{total capacity (Btuh)}}{4.5 \times \text{cfm}}$$

- Where: h_{ewb} = Enthalpy of air entering evaporator coil.
 3. SHC is based on 80 F edb temperature of air entering evaporator coil.
 Below 80 F edb, subtract (corr factor x cfm) from SHC.
 Above 80 F edb, add (corr factor x cfm) to SHC.

BF	ENTERING AIR DRY-BULB TEMP (F)					
	79	78	77	76	75	under 75
	81	82	83	84	85	over 85
Correction Factor						
.05	1.04	2.09	3.14	4.18	5.22	Use formula shown below
.10	0.99	1.98	2.97	3.96	4.95	
.20	0.88	1.76	2.64	3.52	4.40	

Interpolation is permissible.
 Correction Factor = $1.10 \times (1 - \text{BF}) \times (\text{edb} - 80)$.

- Cooling capacities are gross and do not include deduction for indoor fan motor heat.

COOLING CAPACITIES (cont)

48/50P2,P3,P4,P5050 (50 TON) HIGH-CAPACITY COIL — SUBCOOL MODE

Temp (F) Air Entering Condenser (Edb)		Evaporator Air Quantity — Cfm																			
		10,000					12,500					15,000					17,500				
		Evaporator Air — Ewb (F)																			
		75	72	67	62	57	75	72	67	62	57	75	72	67	62	57	75	72	67	62	57
75	TC	589	555	500	454	407	633	597	538	489	452	673	619	563	515	482	697	653	583	534	509
	SHC	191	216	261	316	365	209	238	301	366	427	241	260	335	411	468	251	297	367	452	509
	kW	33.4	32.8	32.0	31.2	30.5	34.2	33.6	32.5	31.7	31.1	35.1	33.9	33.0	32.1	31.5	34.6	33.3	32.4	32.4	32.0
	BF	0.00	0.00	0.07	0.16	0.13	0.00	0.11	0.24	0.16	0.18	0.00	0.10	0.21	0.18	0.24	0.14	0.30	0.21	0.19	0.28
85	TC	552	523	468	445	408	592	557	506	470	436	618	581	531	488	460	640	601	550	502	483
	SHC	160	190	233	300	371	175	205	275	345	424	192	228	309	390	460	201	252	340	432	483
	kW	36.7	36.1	35.2	34.7	34.3	34.2	36.8	35.8	35.1	34.6	37.9	37.2	36.3	35.5	35.0	38.3	37.6	36.6	35.8	35.4
	BF	0.00	0.00	0.07	0.07	0.08	0.00	0.10	0.23	0.09	0.13	0.00	0.09	0.21	0.10	0.20	0.13	0.29	0.21	0.12	0.29
95	TC	514	485	436	418	382	551	510	475	441	417	575	543	499	457	435	597	564	518	470	453
	SHC	128	159	206	279	350	142	162	249	323	406	158	198	282	365	435	166	221	314	405	453
	kW	40.5	39.9	39.1	38.9	38.5	41.2	40.5	39.8	39.3	38.9	41.7	41.1	40.3	39.7	39.2	42.2	41.5	40.7	39.9	39.5
	BF	0.00	0.00	0.07	0.07	0.08	0.00	0.09	0.22	0.08	0.14	0.15	0.09	0.20	0.10	0.22	0.12	0.28	0.21	0.13	0.30
105	TC	477	450	402	387	365	511	473	440	408	363	537	504	464	423	405	555	525	482	436	425
	SHC	97	130	179	255	334	110	131	222	298	354	121	166	255	339	405	133	191	286	378	425
	kW	44.9	44.5	43.9	43.9	43.6	45.7	45.1	44.6	44.3	43.8	46.3	45.7	45.1	44.7	44.2	46.7	46.2	45.5	44.8	44.5
	BF	0.00	0.00	0.06	0.07	0.11	0.00	0.09	0.21	0.08	0.16	0.13	0.08	0.20	0.10	0.24	0.11	0.27	0.20	0.13	0.31
115	TC	438	412	365	353	340	469	430	402	372	333	493	461	424	387	381	511	482	441	400	398
	SHC	64	100	151	230	314	77	99	194	271	326	87	134	226	312	381	99	159	256	345	398
	kW	50.1	49.9	49.6	50.5	51.4	50.9	50.4	50.3	50.9	50.6	51.5	51.1	50.8	51.0	50.7	52.0	51.5	51.1	50.2	50.7
	BF	0.00	0.10	0.06	0.07	0.11	0.00	0.08	0.21	0.08	0.18	0.11	0.08	0.20	0.11	0.26	0.10	0.26	0.20	0.15	0.33

48/50P2,P3,P4,P5050 (50 TON) HIGH-CAPACITY COIL — SUBCOOL MODE (cont)

Temp (F) Air Entering Condenser (Edb)		Evaporator Air Quantity — Cfm				
		20,000				
		Evaporator Air — Ewb (F)				
		75	72	67	62	57
75	TC	707	650	597	548	527
	SHC	262	298	395	487	527
	kW	35.6	34.3	33.5	32.7	32.3
	BF	0.12	0.26	0.22	0.22	0.35
85	TC	650	616	564	517	506
	SHC	211	271	369	473	506
	kW	38.5	37.9	36.9	36.1	35.8
	BF	0.12	0.26	0.21	0.15	0.35
95	TC	611	579	532	500	471
	SHC	181	242	342	458	471
	kW	42.5	41.8	40.9	40.2	39.8
	BF	0.11	0.25	0.21	0.16	0.36
105	TC	570	539	496	446	442
	SHC	148	211	315	411	442
	kW	47.1	46.5	45.8	44.9	44.8
	BF	0.11	0.25	0.21	0.16	0.38
115	TC	524	495	454	411	403
	SHC	115	178	285	378	403
	kW	52.4	51.8	51.4	50.6	50.6
	BF	0.10	0.25	0.21	0.18	0.39

LEGEND

48/50P3,P5 units only.

BF — Bypass Factor **kW** — Compressor Motor Power Input
Edb — Entering Dry Bulb **SHC** — Sensible Heat Cap. (1000 Btuh)
Ewb — Entering Wet Bulb **TC** — Total Cap. (1000 Btuh) Gross

NOTES:

1. The SHC is based on 80 F edb temperature of air entering evaporator coil. For edb temperatures other than 80 F, adjust SHC by multiplying the correction factor and the cfm and then adding or subtracting the value from the SHC.

2. Interpolation is permissible.
3. Correction Factor = $1.10 \times (1 - BF) \times (edb - 80)$.
4. Cooling capacities are gross and do not include deduction for indoor fan motor heat.
5. SHC values provided are in subcooling mode with the gas bypass valve closed and reflect the maximum SHC in subcooling mode. The P Series innovative modulating valve system can reduce SHC as needed to meet the supply air set point requirement with minimal change in latent capacity. This will provide variable SHC to meet the space load.

Performance data (cont)



COOLING CAPACITIES (cont)

48/50P2,P3,P4,P5050 (50 TON) HIGH-CAPACITY COIL — HOT GAS REHEAT MODE

Temp (F) Air Ent Condenser (Edb)		Air Entering Evaporator — Ewb (F)									
		75 Dry Bulb 62.5 Wet Bulb (50% RH)					75 Dry Bulb 65.3 Wet Bulb (60% RH)				
		Air Entering Evaporator — Cfm									
		10,000	12,500	15,000	17,500	20,000	10,000	12,500	15,000	17,500	20,000
80	TC	203	217	226	233	238	212	228	238	245	249
	SHC	11	27	44	62	82	-37	-24	-12	1	15
	kW	34.3	34.6	34.8	35.0	35.1	35.5	35.6	35.8	35.9	36.0
	BF	0.07	0.22	0.21	0.21	0.22	0.11	0.09	0.26	0.24	0.24
75	TC	205	219	229	237	242	215	230	240	248	254
	SHC	13	28	46	64	81	-34	-22	-11	2	15
	kW	33.4	33.7	33.9	34.1	34.3	34.6	34.8	34.9	35.1	35.2
	BF	0.07	0.22	0.21	0.21	0.23	0.12	0.09	0.26	0.24	0.24
70	TC	204	218	228	235	240	214	229	239	246	252
	SHC	13	28	46	64	81	-34	-22	-11	2	15
	kW	34.0	34.4	34.7	34.9	35.2	35.2	35.5	35.7	36.0	36.1
	BF	0.07	0.22	0.21	0.21	0.22	0.12	0.09	0.26	0.24	0.24
60	TC	209	223	233	240	245	220	234	245	252	258
	SHC	16	31	49	67	84	-30	-19	-7	6	19
	kW	32.5	32.8	33.1	33.3	33.6	33.8	33.9	34.2	34.4	34.6
	BF	0.08	0.22	0.21	0.21	0.22	0.00	0.10	0.26	0.24	0.24
50	TC	214	229	239	246	252	225	240	251	259	265
	SHC	19	35	52	71	91	-26	-15	-3	9	23
	kW	31.4	31.7	32.0	32.2	32.3	32.6	32.8	33.0	33.2	33.4
	BF	0.08	0.22	0.21	0.21	0.21	0.00	0.10	0.25	0.24	0.24
40	TC	218	232	243	250	256	228	244	254	262	268
	SHC	22	37	55	73	94	-24	-12	-1	12	26
	kW	30.8	31.0	31.2	31.4	31.6	32.0	32.0	32.2	32.4	32.5
	BF	0.08	0.22	0.21	0.21	0.21	0.00	0.10	0.25	0.24	0.24

48/50P2,P3,P4,P5050 (50 TON) HIGH-CAPACITY COIL — HOT GAS REHEAT MODE (cont)

Temp (F) Air Ent Condenser (Edb)		Air Entering Evaporator — Ewb (F)									
		75 Dry Bulb 68 Wet Bulb (70% RH)					75 Dry Bulb 70.5 Wet Bulb (80% RH)				
		Air Entering Evaporator — Cfm									
		10,000	12,500	15,000	17,500	20,000	10,000	12,500	15,000	17,500	20,000
80	TC	223	238	249	257	263	233	250	262	270	276
	SHC	-72	-75	-68	-60	-51	-104	-113	-113	-116	-113
	kW	36.4	36.8	36.9	37.0	37.1	37.4	37.7	37.8	38.0	38.1
	BF	0.00	0.15	0.11	0.11	0.28	0.00	0.00	0.00	0.18	0.13
75	TC	227	242	253	261	267	237	254	266	274	280
	SHC	-70	-73	-66	-57	-50	-102	-111	-111	-113	-112
	kW	35.6	35.9	36.0	36.1	36.3	36.6	36.8	37.0	37.1	37.3
	BF	0.00	0.00	0.11	0.11	0.29	0.00	0.00	0.00	0.00	0.14
70	TC	225	239	249	257	263	234	250	261	269	275
	SHC	-71	-73	-66	-58	-49	-103	-111	-111	-117	-112
	kW	36.3	36.8	36.9	37.1	37.2	37.3	37.8	38.0	38.3	38.3
	BF	0.00	0.16	0.11	0.11	0.27	0.00	0.00	0.00	0.18	0.14
60	TC	232	246	257	265	271	241	257	270	277	283
	SHC	-68	-69	-62	-53	-45	-98	-105	-107	-113	-108
	kW	34.8	35.2	35.3	35.5	35.6	35.8	36.1	36.4	36.6	36.8
	BF	0.00	0.00	0.12	0.11	0.28	0.00	0.00	0.00	0.00	0.14
50	TC	236	251	263	271	278	246	262	275	283	292
	SHC	-62	-68	-58	-50	-42	-94	-101	-111	-110	-105
	kW	33.6	34.1	34.2	34.3	34.4	34.6	34.9	35.2	35.3	35.3
	BF	0.00	0.00	0.12	0.11	0.28	0.00	0.00	0.00	0.00	0.15
40	TC	238	254	266	274	280	248	264	277	286	292
	SHC	-61	-65	-57	-47	-39	-92	-99	-109	-107	-103
	kW	32.9	33.3	33.3	33.4	33.5	33.8	34.1	34.3	34.4	34.4
	BF	0.00	0.00	0.13	0.31	0.28	0.00	0.00	0.00	0.00	0.16

LEGEND

BF — Bypass Factor
Edb — Entering Dry Bulb
Ewb — Entering Wet Bulb
kW — Compressor Motor Power Input
RH — Relative Humidity
SHC — Sensible Heat Cap. (1000 Btu/h)
TC — Total Cap. (1000 Btu/h) Gross

6. SHC values provided reflect maximum reheat values with 100% gas bypass. Negative SHC value indicates that the air entering the coil is being heated at 100% gas bypass. The P Series innovative modulating valve system will reduce the gas bypass as required to meet the supply air setpoint with minimal change in latent capacity. The space will NOT be overheated and the unit will provide variable SHC to meet the space load.

NOTES:

- The SHC is based on 75 F edb temperature of air entering evaporator coil. For edb temperatures other than 75 F, adjust SHC by multiplying the correction factor and the cfm and then adding or subtracting the value from the SHC.
- Interpolation is permissible.
- Correction Factor = $1.10 \times (1 - BF) \times (edb - 75)$.
- Cooling capacities are gross and do not include deduction for indoor fan motor heat.
- Capacity table includes impact of outdoor fan staging at temperatures below 75 F.

COOLING CAPACITIES (cont)

48/50P2,P3,P4,P5055 (55 TON) STANDARD CAPACITY COIL — STANDARD MODE

Temp (F) Air Entering Condenser (Edb)		Evaporator Air Quantity — Cfm																			
		11,000					13,750					16,500					19,250				
		Evaporator Air — Ewb (F)																			
		75	72	67	62	57	75	72	67	62	57	75	72	67	62	57	75	72	67	62	57
75	TC	685	654	604	558	510	722	686	636	588	538	744	709	656	609	572	761	726	672	625	598
	SHC	281	311	375	434	486	292	338	412	485	525	307	361	446	531	572	322	381	477	572	598
	KW	37.2	36.5	35.5	34.8	34.6	37.9	37.2	36.1	35.3	34.6	38.4	37.6	36.5	35.7	35.2	38.8	38.0	36.9	36.1	35.6
	BF	0.00	0.00	0.15	0.11	0.11	0.00	0.24	0.14	0.12	0.18	0.00	0.19	0.15	0.13	0.25	0.29	0.19	0.16	0.15	0.33
85	TC	663	636	588	540	491	697	665	618	570	519	717	687	638	589	556	732	702	653	604	582
	SHC	271	304	368	425	474	281	330	405	476	506	299	352	438	522	556	313	373	470	562	582
	KW	41.0	40.5	39.7	39.3	39.2	41.8	41.1	40.3	39.8	39.1	42.3	41.6	40.7	40.1	39.7	42.6	41.9	41.0	40.5	40.0
	BF	0.00	0.00	0.15	0.11	0.11	0.00	0.21	0.14	0.12	0.19	0.13	0.19	0.15	0.13	0.28	0.26	0.18	0.16	0.16	0.35
95	TC	646	619	570	520	466	676	647	598	547	504	694	667	617	566	537	708	681	631	580	563
	SHC	264	298	359	415	451	276	323	396	466	504	292	346	430	505	537	306	366	461	549	563
	KW	45.7	45.3	44.9	44.7	45.6	46.4	45.9	45.4	45.2	45.2	46.8	46.4	45.8	45.5	45.2	47.1	46.7	46.1	45.9	45.4
	BF	0.00	0.00	0.14	0.11	0.12	0.00	0.19	0.13	0.11	0.21	0.11	0.18	0.14	0.13	0.30	0.23	0.18	0.16	0.16	0.37
105	TC	626	597	546	495	443	654	624	572	522	485	671	642	590	539	516	686	655	604	552	542
	SHC	256	290	349	404	443	269	315	386	454	485	284	337	419	497	516	299	357	451	533	542
	KW	51.3	51.2	51.1	52.1	54.4	51.9	51.7	51.6	52.0	53.0	52.4	52.2	51.9	52.5	52.5	52.8	52.5	52.2	52.5	51.9
	BF	0.00	0.10	0.13	0.10	0.13	0.00	0.18	0.13	0.11	0.24	0.26	0.17	0.14	0.14	0.33	0.22	0.17	0.15	0.17	0.39
115	TC	602	570	519	468	—	626	595	544	492	—	643	612	561	508	494	657	625	573	521	517
	SHC	243	280	337	390	—	261	305	374	440	—	275	326	407	481	494	289	347	439	513	517
	KW	58.1	58.2	59.6	62.5	—	58.5	58.6	59.7	62.3	—	58.9	59.0	59.8	62.2	61.0	59.5	59.3	59.9	61.3	61.1
	BF	0.00	0.22	0.12	0.10	—	0.12	0.16	0.12	0.11	—	0.23	0.16	0.14	0.14	0.36	0.20	0.16	0.15	0.19	0.42

48/50P2,P3,P4,P5055 (55 TON) STANDARD CAPACITY COIL — STANDARD MODE (cont)

Temp (F) Air Entering Condenser (Edb)		Evaporator Air Quantity — Cfm									
		22,000					24,750				
		Evaporator Air — Ewb (F)									
		75	72	67	62	57	75	72	67	62	57
75	TC	773	738	684	636	620	785	748	693	642	638
	SHC	335	401	508	607	620	348	419	536	627	638
	KW	39.1	38.3	37.1	36.3	35.9	39.3	38.5	37.3	36.3	36.3
	BF	0.25	0.19	0.17	0.18	0.39	0.24	0.20	0.18	0.23	0.45
85	TC	745	712	664	615	604	755	721	673	623	621
	SHC	326	392	500	594	604	339	411	529	614	621
	KW	42.9	42.2	41.3	40.6	40.2	43.2	42.3	41.5	40.6	40.6
	BF	0.23	0.19	0.17	0.19	0.41	0.23	0.19	0.18	0.23	0.46
95	TC	722	691	642	592	585	732	701	650	602	602
	SHC	319	385	491	579	585	331	402	520	595	602
	KW	47.5	46.9	46.3	45.9	45.6	47.8	47.2	46.5	45.8	45.9
	BF	0.22	0.18	0.17	0.20	0.43	0.22	0.20	0.18	0.25	0.48
105	TC	697	664	614	565	562	706	674	622	578	578
	SHC	311	377	481	555	562	324	393	509	572	578
	KW	53.1	52.6	52.4	51.9	52.0	53.4	53.0	52.6	52.1	52.1
	BF	0.21	0.17	0.17	0.23	0.45	0.21	0.19	0.18	0.28	0.50
115	TC	666	633	582	539	536	674	640	590	554	553
	SHC	302	365	469	532	536	314	383	497	550	553
	KW	59.8	59.1	59.9	60.4	60.8	60.0	59.2	60.0	60.4	60.5
	BF	0.20	0.17	0.16	0.26	0.48	0.20	0.18	0.18	0.32	0.52

LEGEND

48/50P3,P5 units only.

BF — Bypass Factor **KW** — Compressor Motor Power Input
Edb — Entering Dry Bulb **SHC** — Sensible Heat Cap. (1000 Btuh)
Ewb — Entering Wet Bulb **TC** — Total Cap. (1000 Btuh) Gross

NOTES:

- Direct interpolation is permissible. Do not extrapolate.
- The following formulas may be used:

$$t_{db} = t_{edb} - \frac{\text{sensible capacity (Btuh)}}{1.10 \times \text{cfm}}$$

t_{wb} = Wet-bulb temperature corresponding to enthalpy of air leaving evaporator coil (h_{wb}).

$$h_{wb} = h_{ewb} - \frac{\text{total capacity (Btuh)}}{4.5 \times \text{cfm}}$$

Where: h_{ewb} = Enthalpy of air entering evaporator coil.

- SHC is based on 80 F edb temperature of air entering evaporator coil.
Below 80 F edb, subtract (corr factor x cfm) from SHC.
Above 80 F edb, add (corr factor x cfm) to SHC.

BF	ENTERING AIR DRY-BULB TEMP (F)					
	79	78	77	76	75	under 75
	81	82	83	84	85	over 85
Correction Factor						
.05	1.04	2.09	3.14	4.18	5.22	Use formula shown below
.10	0.99	1.98	2.97	3.96	4.95	
.20	0.88	1.76	2.64	3.52	4.40	

Interpolation is permissible.
Correction Factor = $1.10 \times (1 - BF) \times (edb - 80)$.

- Cooling capacities are gross and do not include deduction for indoor fan motor heat.

Performance data (cont)



COOLING CAPACITIES (cont)

48/50P2,P3,P4,P5055 (55 TON) STANDARD CAPACITY COIL — SUBCOOL MODE

Temp (F) Air Entering Condenser (Edb)		Evaporator Air Quantity — Cfm																			
		11,000					13,750					16,500					19,250				
		Evaporator Air — Ewb (F)																			
		75	72	67	62	57	75	72	67	62	57	75	72	67	62	57	75	72	67	62	57
75	TC	648	613	562	501	464	681	647	598	541	494	704	668	615	561	523	719	684	630	578	549
	SHC	206	244	311	364	434	221	269	354	424	487	236	290	383	471	523	248	310	415	515	549
	kW	41.9	41.3	40.5	39.7	39.2	42.5	41.9	41.2	40.2	39.6	43.0	42.3	41.4	40.5	40.0	43.3	42.6	41.6	40.8	40.3
	BF	0.03	0.08	0.08	0.07	0.08	0.12	0.10	0.09	0.09	0.14	0.14	0.12	0.12	0.11	0.23	0.16	0.15	0.14	0.14	0.31
85	TC	573	588	536	488	443	652	619	567	516	472	672	639	586	537	500	687	654	602	551	525
	SHC	139	226	292	357	416	200	249	329	407	466	213	269	361	453	500	225	289	394	495	525
	kW	44.8	45.1	44.3	43.7	43.0	46.2	45.6	44.8	44.1	43.4	46.6	46.0	45.1	44.3	43.8	46.9	46.3	45.3	44.5	44.2
	BF	0.04	0.08	0.08	0.07	0.09	0.12	0.10	0.09	0.09	0.15	0.14	0.13	0.12	0.12	0.24	0.16	0.15	0.14	0.14	0.32
95	TC	591	560	510	463	422	621	515	538	490	455	640	533	558	509	476	652	623	572	522	500
	SHC	165	206	273	338	403	178	154	309	388	455	191	172	342	433	476	200	267	373	473	500
	kW	50.0	49.5	48.8	48.1	47.7	50.5	48.6	49.2	48.5	48.4	50.9	48.9	49.4	48.7	48.2	51.1	50.6	49.7	48.9	48.6
	BF	0.05	0.08	0.08	0.07	0.10	0.12	0.10	0.09	0.09	0.16	0.14	0.13	0.12	0.12	0.26	0.16	0.15	0.14	0.14	0.33
105	TC	560	529	481	436	395	588	557	508	462	424	606	576	526	479	451	623	589	539	491	474
	SHC	143	185	253	319	374	156	205	288	368	424	167	225	320	411	451	183	243	351	450	474
	kW	55.0	54.5	53.8	53.6	53.3	55.5	54.9	54.1	53.6	53.3	55.8	55.2	54.4	53.7	53.5	56.2	55.5	54.6	53.8	53.6
	BF	0.05	0.08	0.08	0.08	0.12	0.12	0.10	0.10	0.09	0.18	0.14	0.13	0.12	0.12	0.27	0.16	0.15	0.14	0.15	0.35
115	TC	526	497	451	408	371	552	523	476	432	398	569	540	493	448	424	584	552	505	460	457
	SHC	121	163	232	299	352	132	183	266	347	398	143	201	298	389	424	157	219	328	422	457
	kW	60.7	60.3	60.0	60.1	60.0	61.0	60.5	60.0	59.8	59.8	61.4	60.8	60.1	59.8	59.7	61.7	61.0	60.2	59.7	60.4
	BF	0.05	0.08	0.08	0.08	0.14	0.12	0.10	0.10	0.10	0.20	0.14	0.13	0.12	0.12	0.29	0.16	0.15	0.14	0.17	0.37

48/50P2,P3,P4,P5055 (55 TON) STANDARD CAPACITY COIL — SUBCOOL MODE (cont)

Temp (F) Air Entering Condenser (Edb)		Evaporator Air Quantity — Cfm									
		22,000					24,750				
		Evaporator Air — Ewb (F)									
		75	72	67	62	57	75	72	67	62	57
75	TC	732	699	641	589	571	742	709	651	598	597
	SHC	260	332	445	553	571	272	350	474	584	597
	kW	43.5	43.0	41.9	41.0	40.7	43.8	43.2	42.1	41.1	41.3
	BF	0.18	0.16	0.15	0.17	0.37	0.20	0.18	0.17	0.20	0.43
85	TC	698	666	554	561	555	707	677	621	571	564
	SHC	237	307	366	531	555	248	327	453	560	564
	kW	47.2	46.5	44.5	44.7	44.9	47.4	46.8	45.7	44.8	44.8
	BF	0.18	0.17	0.15	0.17	0.39	0.20	0.18	0.17	0.21	0.44
95	TC	665	634	582	532	530	674	642	591	543	545
	SHC	214	285	403	508	530	224	302	431	531	545
	kW	51.4	50.8	49.8	49.0	49.4	51.6	51.0	50.0	49.2	49.5
	BF	0.18	0.17	0.15	0.18	0.40	0.20	0.18	0.17	0.23	0.45
105	TC	633	599	549	503	502	638	607	557	514	518
	SHC	193	261	380	476	502	200	278	408	504	518
	kW	56.4	55.7	54.8	54.0	54.4	56.4	55.8	54.9	54.1	54.6
	BF	0.18	0.17	0.16	0.20	0.41	0.20	0.18	0.17	0.24	0.46
115	TC	591	562	514	473	463	599	569	522	482	488
	SHC	164	237	357	449	463	174	253	384	475	488
	kW	61.8	61.2	60.3	59.7	59.7	62.0	61.3	60.4	59.8	60.3
	BF	0.18	0.17	0.16	0.22	0.43	0.20	0.18	0.17	0.26	0.48

LEGEND

48/50P3,P5 units only.

BF — Bypass Factor **kW** — Compressor Motor Power Input
Edb — Entering Dry Bulb **SHC** — Sensible Heat Cap. (1000 Btuh)
Ewb — Entering Wet Bulb **TC** — Total Cap. (1000 Btuh) Gross

NOTES:

- The SHC is based on 80 F edb temperature of air entering evaporator coil. For edb temperatures other than 80 F, adjust SHC by multiplying the correction factor and the cfm and then adding or subtracting the value from the SHC.

- Interpolation is permissible.
- Correction Factor = $1.10 \times (1 - BF) \times (edb - 80)$.
- Cooling capacities are gross and do not include deduction for indoor fan motor heat.
- SHC values provided are in subcooling mode with the gas bypass valve closed and reflect the maximum SHC in subcooling mode. The P Series innovative modulating valve system can reduce SHC as needed to meet the supply air set point requirement with minimal change in latent capacity. This will provide variable SHC to meet the space load.

COOLING CAPACITIES (cont)

48/50P2,P3,P4,P5055 (55 TON) STANDARD CAPACITY COIL — HOT GAS REHEAT MODE

Temp (F) Air Ent Condenser (Edb)		Air Entering Evaporator — Ewb (F)											
		75 Dry Bulb 62.5 Wet Bulb (50% RH)						75 Dry Bulb 65.3 Wet Bulb (60% RH)					
		Air Entering Evaporator — Cfm											
		11,000	13,750	16,500	19,250	22,000	24,750	11,000	13,750	16,500	19,250	22,000	24,750
80	TC	225	242	252	260	266	270	238	256	267	275	281	285
	SHC	24	46	69	92	115	138	-25	-11	4	20	37	54
	kW	42.8	42.4	42.3	42.2	42.2	42.2	43.4	43.0	42.8	42.7	42.7	42.7
	BF	0.08	0.09	0.12	0.13	0.15	0.17	0.08	0.10	0.12	0.14	0.16	0.17
75	TC	230	247	258	266	272	276	244	261	273	281	286	291
	SHC	27	49	72	94	118	141	-22	-8	7	23	39	56
	kW	41.4	41.0	40.8	40.8	40.8	40.8	42.0	41.6	41.5	41.4	41.4	41.4
	BF	0.08	0.09	0.11	0.13	0.15	0.17	0.08	0.10	0.12	0.14	0.16	0.17
70	TC	230	246	256	264	269	273	243	259	270	277	283	287
	SHC	27	49	71	94	117	140	-22	-9	6	22	38	55
	kW	42.0	41.8	41.7	41.7	41.7	41.7	42.8	42.5	42.4	42.4	42.4	42.4
	BF	0.08	0.09	0.12	0.13	0.15	0.17	0.08	0.10	0.12	0.14	0.16	0.17
60	TC	240	256	266	274	279	284	253	269	280	287	293	297
	SHC	32	54	76	99	122	144	-17	-4	11	27	43	60
	kW	39.5	39.3	39.3	39.3	39.3	39.4	40.3	40.1	40.0	40.1	40.1	40.1
	BF	0.07	0.09	0.11	0.13	0.15	0.17	0.07	0.10	0.12	0.14	0.16	0.17
50	TC	248	265	275	283	289	293	261	278	289	296	302	307
	SHC	37	59	81	103	126	149	-12	1	16	31	47	60
	kW	37.3	37.2	37.3	37.4	37.4	37.5	38.2	38.1	38.1	38.2	38.3	38.4
	BF	0.07	0.09	0.11	0.13	0.15	0.17	0.07	0.10	0.12	0.14	0.16	0.17
40	TC	255	272	283	292	298	304	268	286	298	307	314	319
	SHC	42	63	85	108	125	154	-8	5	20	36	52	69
	kW	35.5	35.6	35.7	35.8	36.0	36.1	36.4	36.5	36.6	36.7	36.9	37.0
	BF	0.07	0.09	0.11	0.13	0.15	0.17	0.07	0.10	0.12	0.14	0.16	0.17

48/50P2,P3,P4,P5055 (55 TON) STANDARD CAPACITY COIL — HOT GAS REHEAT MODE (cont)

Temp (F) Air Ent Condenser (Edb)		Air Entering Evaporator — Ewb (F)											
		75 Dry Bulb 68 Wet Bulb (70% RH)						75 Dry Bulb 70.5 Wet Bulb (80% RH)					
		Air Entering Evaporator — Cfm											
		11,000	13,750	16,500	19,250	22,000	24,750	11,000	13,750	16,500	19,250	22,000	24,750
80	TC	252	270	281	289	295	300	265	283	294	302	309	313
	SHC	-72	-67	-59	-49	-39	-29	-117	-119	-117	-114	-110	-105
	kW	44.1	43.6	43.4	43.3	43.3	43.3	44.8	44.3	44.2	44.0	44.0	44.0
	BF	0.07	0.10	0.12	0.15	0.16	0.18	0.00	0.11	0.14	0.16	0.18	0.20
75	TC	258	275	286	295	301	305	270	288	300	308	314	319
	SHC	-70	-64	-56	-47	-37	-26	-115	-116	-115	-111	-107	-102
	kW	42.7	42.3	42.1	42.0	42.1	42.0	43.5	43.1	42.9	42.8	42.8	42.8
	BF	0.07	0.10	0.12	0.15	0.16	0.18	0.00	0.11	0.14	0.16	0.18	0.20
70	TC	256	272	283	291	296	301	268	285	296	303	309	314
	SHC	-70	-64	-57	-48	-38	-27	-115	-117	-115	-112	-108	-103
	kW	43.6	43.2	43.2	43.2	43.2	43.2	44.4	44.1	44.1	44.0	44.0	44.0
	BF	0.07	0.10	0.12	0.15	0.16	0.18	0.00	0.11	0.14	0.16	0.18	0.20
60	TC	265	282	293	301	307	311	277	295	306	314	320	324
	SHC	-65	-59	-52	-43	-33	-23	-110	-112	-110	-108	-103	-99
	kW	41.1	40.9	40.9	40.9	40.9	41.0	42.0	41.8	41.8	41.7	41.8	41.8
	BF	0.07	0.10	0.12	0.15	0.16	0.18	0.00	0.12	0.14	0.16	0.18	0.20
50	TC	274	291	302	310	317	322	286	303	315	324	331	336
	SHC	-60	-55	-47	-39	-29	-22	-106	-107	-106	-103	-99	-94
	kW	39.1	39.0	39.0	39.1	39.2	39.3	40.0	39.9	40.0	40.0	40.1	40.1
	BF	0.07	0.10	0.12	0.14	0.16	0.18	0.00	0.11	0.14	0.16	0.18	0.20
40	TC	281	300	312	322	329	335	294	313	327	337	344	350
	SHC	-56	-51	-43	-33	-23	-13	-102	-103	-101	-98	-94	-89
	kW	37.4	37.4	37.6	37.7	37.7	37.8	38.3	38.4	38.5	38.5	38.6	38.7
	BF	0.07	0.10	0.12	0.14	0.16	0.18	0.00	0.12	0.14	0.16	0.18	0.20

LEGEND

- | | |
|--|--|
| BF — Bypass Factor | RH — Relative Humidity |
| Edb — Entering Dry Bulb | SHC — Sensible Heat Cap. (1000 Btu/h) |
| Ewb — Entering Wet Bulb | TC — Total Cap. (1000 Btu/h) Gross |
| kW — Compressor Motor Power Input | |

- SHC values provided reflect maximum reheat values with 100% gas bypass. Negative SHC value indicates that the air entering the coil is being heated at 100% gas bypass. The P Series innovative modulating valve system will reduce the gas bypass as required to meet the supply air setpoint with minimal change in latent capacity. The space will NOT be overheated and the unit will provide variable SHC to meet the space load.

NOTES:

- The SHC is based on 75 F edb temperature of air entering evaporator coil. For edb temperatures other than 75 F, adjust SHC by multiplying the correction factor and the cfm and then adding or subtracting the value from the SHC.
- Interpolation is permissible.
- Correction Factor = $1.10 \times (1 - BF) \times (edb - 75)$.
- Cooling capacities are gross and do not include deduction for indoor fan motor heat.
- Capacity table includes impact of outdoor fan staging at temperatures below 75 F.

Performance data (cont)



COOLING CAPACITIES (cont)

48/50P2,P3,P4,P5055 (55 TON) HIGH-CAPACITY COIL — STANDARD MODE

Temp (F) Air Entering Condenser (Edb)		Evaporator Air Quantity — Cfm																			
		11,000					13,750					16,500					19,250				
		Evaporator Air — Ewb (F)																			
		75	72	67	62	57	75	72	67	62	57	75	72	67	62	57	75	72	67	62	57
75	TC	693	657	606	556	513	731	694	639	586	542	757	719	661	609	575	776	737	678	625	602
	SHC	285	318	379	438	494	299	346	419	490	542	318	369	454	539	575	334	390	488	581	602
	kW	37.2	36.5	35.4	34.4	33.6	38.0	37.2	36.1	35.0	34.2	38.5	37.7	36.5	35.5	34.9	38.8	38.1	36.9	35.8	35.4
	BF	0.00	0.08	0.12	0.09	0.09	0.00	0.15	0.11	0.09	0.15	0.08	0.15	0.12	0.11	0.25	0.18	0.16	0.13	0.13	0.33
85	TC	675	641	591	544	501	709	674	623	573	532	735	699	645	596	565	757	717	661	609	591
	SHC	277	312	372	432	486	292	339	412	484	532	311	361	447	532	565	327	383	481	575	591
	kW	41.1	40.4	39.3	38.5	37.9	41.9	41.1	40.0	39.0	38.3	42.4	41.6	40.5	39.6	38.9	42.9	42.0	40.9	39.8	39.5
	BF	0.00	0.08	0.11	0.08	0.09	0.00	0.14	0.11	0.09	0.17	0.21	0.15	0.12	0.11	0.27	0.17	0.15	0.13	0.13	0.34
95	TC	659	627	578	530	487	692	659	608	558	519	719	682	628	576	551	737	699	644	592	577
	SHC	271	306	367	425	480	287	333	405	476	519	305	355	440	525	551	321	376	474	561	577
	kW	45.7	45.1	44.3	43.5	43.4	46.5	45.9	44.9	44.1	43.5	47.4	46.5	45.5	44.5	44.1	48.0	47.0	45.9	44.9	44.6
	BF	0.00	0.06	0.11	0.08	0.11	0.11	0.13	0.11	0.10	0.19	0.19	0.14	0.12	0.10	0.28	0.17	0.15	0.13	0.15	0.36
105	TC	641	610	558	507	463	674	639	586	534	503	696	659	605	555	533	711	674	619	568	558
	SHC	264	299	358	415	458	281	325	396	467	503	298	347	431	509	533	312	367	464	548	558
	kW	51.6	51.1	50.6	49.7	50.7	52.9	51.9	51.3	50.2	49.3	54.0	52.9	51.9	51.2	50.7	54.8	53.5	52.3	51.4	51.1
	BF	0.00	0.18	0.10	0.07	0.12	0.09	0.12	0.10	0.08	0.21	0.17	0.14	0.11	0.12	0.31	0.15	0.15	0.13	0.15	0.38
115	TC	615	581	528	476	436	644	609	554	502	475	663	627	572	519	505	—	641	585	537	529
	SHC	252	289	345	400	433	271	314	383	450	475	287	335	418	494	505	—	356	451	523	529
	kW	60.1	59.8	59.8	58.7	60.6	62.3	61.0	60.6	61.0	60.4	64.3	62.2	61.4	61.3	60.6	—	63.6	61.9	60.8	61.1
	BF	0.00	0.14	0.09	0.07	0.16	0.20	0.12	0.10	0.09	0.26	0.15	0.13	0.11	0.12	0.34	—	0.14	0.13	0.18	0.41

48/50P2,P3,P4,P5055 (55 TON) HIGH-CAPACITY COIL — STANDARD MODE (cont)

Temp (F) Air Entering Condenser (Edb)		Evaporator Air Quantity — Cfm									
		22,000					24,750				
		Evaporator Air — Ewb (F)									
		75	72	67	62	57	75	72	67	62	57
75	TC	791	751	691	637	625	805	762	702	650	644
	SHC	348	410	520	614	625	359	429	550	639	644
	kW	39.1	38.3	37.2	36.1	35.8	39.4	38.6	37.4	36.4	36.2
	BF	0.17	0.16	0.14	0.17	0.39	0.20	0.17	0.15	0.22	0.44
85	TC	771	730	673	621	612	787	743	684	634	632
	SHC	341	403	512	606	612	354	422	543	620	632
	kW	43.2	42.4	41.2	40.1	39.9	43.7	42.7	41.4	40.4	40.3
	BF	0.17	0.16	0.14	0.17	0.40	0.19	0.18	0.15	0.24	0.45
95	TC	753	713	655	606	598	764	723	665	617	616
	SHC	333	396	505	589	598	346	416	536	610	616
	kW	48.8	47.6	46.2	45.2	45.0	49.3	47.8	46.5	45.3	45.4
	BF	0.18	0.17	0.14	0.20	0.42	0.19	0.17	0.15	0.25	0.47
105	TC	724	686	630	584	578	733	696	638	596	596
	SHC	324	387	495	570	578	336	406	525	596	596
	kW	56.4	54.1	52.7	51.4	51.6	57.1	54.8	52.9	52.0	51.9
	BF	0.18	0.16	0.14	0.22	0.44	0.18	0.17	0.15	0.26	0.48
115	TC	—	652	595	551	550	—	—	603	570	567
	SHC	—	375	482	548	550	—	—	511	561	567
	kW	—	65.0	62.3	61.3	61.4	—	—	63.1	61.2	61.7
	BF	—	0.16	0.14	0.24	0.46	—	—	0.16	0.31	0.51

LEGEND

48/50P3,P5 units only.

BF — Bypass Factor **kW** — Compressor Motor Power Input
Edb — Entering Dry Bulb **SHC** — Sensible Heat Cap. (1000 Btuh)
Ewb — Entering Wet Bulb **TC** — Total Cap. (1000 Btuh) Gross

NOTES:

- Direct interpolation is permissible. Do not extrapolate.
- The following formulas may be used:

$$t_{db} = t_{edb} - \frac{\text{sensible capacity (Btuh)}}{1.10 \times \text{cfm}}$$

$$t_{lwb} = \text{Wet-bulb temperature corresponding to enthalpy of air leaving evaporator coil (} h_{lwb} \text{).}$$

$$h_{lwb} = h_{ewb} - \frac{\text{total capacity (Btuh)}}{4.5 \times \text{cfm}}$$

Where: h_{ewb} = Enthalpy of air entering evaporator coil.

- SHC is based on 80 F edb temperature of air entering evaporator coil. Below 80 F edb, subtract (corr factor x cfm) from SHC. Above 80 F edb, add (corr factor x cfm) to SHC.

		ENTERING AIR DRY-BULB TEMP (F)					
		79	78	77	76	75	under 75
BF	81	82	83	84	85	over 85	
	Correction Factor						
.05	1.04	2.09	3.14	4.18	5.22	Use formula shown below	
.10	0.99	1.98	2.97	3.96	4.95		
.20	0.88	1.76	2.64	3.52	4.40		

Interpolation is permissible.
 Correction Factor = $1.10 \times (1 - \text{BF}) \times (\text{edb} - 80)$.

- Cooling capacities are gross and do not include deduction for indoor fan motor heat.

COOLING CAPACITIES (cont)

48/50P2,P3,P4,P5055 (55 TON) HIGH-CAPACITY COIL — SUBCOOL MODE

Temp (F) Air Entering Condenser (Edb)		Evaporator Air Quantity — Cfm																			
		11,000					13,750					16,500					19,250				
		Evaporator Air — Ewb (F)																			
		75	72	67	62	57	75	72	67	62	57	75	72	67	62	57	75	72	67	62	57
75	TC	639	598	533	481	441	678	632	569	510	476	704	658	588	535	500	721	671	618	550	524
	SHC	174	211	270	338	411	194	237	316	392	467	213	263	350	448	500	227	282	403	496	524
	kW	42.0	41.3	40.2	39.3	38.7	42.8	42.0	40.9	39.9	39.2	43.3	42.5	41.2	40.3	39.7	43.6	42.7	41.7	40.6	40.2
	BF	0.03	0.02	0.02	0.02	0.03	0.05	0.03	0.02	0.03	0.09	0.06	0.04	0.04	0.04	0.17	0.08	0.06	0.05	0.06	0.26
85	TC	591	553	497	449	415	618	577	534	473	446	663	616	552	491	467	676	629	566	502	490
	SHC	133	172	241	311	387	143	189	286	360	438	182	231	322	410	467	192	251	358	453	490
	kW	45.4	44.7	43.7	43.0	42.5	46.0	45.2	44.3	43.3	42.8	46.7	45.9	44.7	43.7	43.2	47.0	46.2	45.0	43.9	43.6
	BF	0.02	0.02	0.02	0.02	0.03	0.05	0.03	0.02	0.03	0.10	0.06	0.04	0.04	0.04	0.18	0.07	0.06	0.05	0.06	0.27
95	TC	563	525	469	415	395	595	552	493	436	416	618	573	510	452	433	621	568	523	467	455
	SHC	113	151	219	283	371	128	172	253	330	410	144	195	288	378	433	144	197	323	424	455
	kW	49.6	48.9	47.9	47.3	46.9	50.2	49.4	48.3	47.5	47.2	50.7	49.8	48.6	47.7	47.4	50.9	49.9	48.9	47.9	47.7
	BF	0.02	0.02	0.02	0.02	0.06	0.05	0.03	0.02	0.03	0.11	0.06	0.04	0.04	0.04	0.20	0.07	0.05	0.05	0.06	0.28
105	TC	511	476	423	380	364	554	512	454	407	389	577	514	457	413	399	572	529	468	433	417
	SHC	70	111	181	256	339	97	141	222	310	384	114	145	243	346	399	106	167	276	388	417
	kW	54.3	53.6	52.7	52.5	52.6	55.0	54.1	53.1	52.4	52.3	55.5	54.3	53.2	52.5	52.3	55.6	54.6	53.4	52.7	52.5
	BF	0.02	0.02	0.02	0.02	0.06	0.05	0.03	0.03	0.03	0.12	0.06	0.04	0.04	0.04	0.21	0.07	0.05	0.05	0.09	0.29
115	TC	469	434	383	343	334	490	453	399	358	350	507	467	411	374	363	520	477	420	393	378
	SHC	39	80	151	228	311	44	93	178	270	347	56	110	208	316	363	68	128	240	351	378
	kW	60.0	59.3	58.9	59.4	59.9	60.4	59.5	58.7	58.7	59.0	60.8	59.7	58.7	58.4	58.5	61.2	59.9	58.7	58.3	58.3
	BF	0.02	0.02	0.02	0.02	0.08	0.05	0.03	0.03	0.03	0.14	0.06	0.04	0.04	0.05	0.23	0.07	0.05	0.05	0.11	0.31

48/50P2,P3,P4,P5055 (55 TON) HIGH-CAPACITY COIL — SUBCOOL MODE (cont)

Temp (F) Air Entering Condenser (Edb)		Evaporator Air Quantity — Cfm									
		22,000					24,750				
		Evaporator Air — Ewb (F)									
		75	72	67	62	57	75	72	67	62	57
75	TC	739	686	746	568	555	752	697	750	582	576
	SHC	246	307	653	537	555	263	329	668	569	576
	kW	43.9	43.0	44.1	40.9	40.7	44.1	43.2	44.2	41.2	41.1
	BF	0.09	0.07	0.36	0.10	0.33	0.10	0.08	0.37	0.14	0.39
85	TC	692	643	573	521	518	704	653	584	531	537
	SHC	210	274	389	491	518	226	297	426	520	537
	kW	47.3	46.5	45.2	44.2	44.1	47.6	46.7	45.4	44.5	44.5
	BF	0.09	0.07	0.06	0.11	0.34	0.10	0.08	0.07	0.15	0.40
95	TC	636	579	535	484	473	666	612	543	495	489
	SHC	161	218	359	456	473	197	264	393	486	489
	kW	51.3	50.1	49.1	48.2	48.1	51.7	50.6	49.3	48.4	48.4
	BF	0.08	0.07	0.06	0.12	0.35	0.10	0.08	0.07	0.16	0.40
105	TC	586	539	475	445	434	593	545	484	454	448
	SHC	122	188	308	419	434	134	207	343	446	448
	kW	56.0	54.8	53.5	52.9	52.8	56.2	55.0	53.7	53.1	53.0
	BF	0.09	0.07	0.06	0.13	0.36	0.10	0.08	0.07	0.17	0.42
115	TC	532	486	427	404	393	543	494	434	410	405
	SHC	82	148	272	380	393	98	169	304	405	405
	kW	61.6	60.1	58.8	58.4	58.3	62.0	60.3	58.9	58.4	58.4
	BF	0.09	0.07	0.06	0.15	0.38	0.10	0.08	0.08	0.19	0.43

LEGEND

48/50P3,P5 units only.

BF — Bypass Factor **kW** — Compressor Motor Power Input
Edb — Entering Dry Bulb **SHC** — Sensible Heat Cap. (1000 Btuh)
Ewb — Entering Wet Bulb **TC** — Total Cap. (1000 Btuh) Gross

NOTES:

- The SHC is based on 80 F edb temperature of air entering evaporator coil. For edb temperatures other than 80 F, adjust SHC by multiplying the correction factor and the cfm and then adding or subtracting the value from the SHC.

- Interpolation is permissible.
- Correction Factor = $1.10 \times (1 - BF) \times (edb - 80)$.
- Cooling capacities are gross and do not include deduction for indoor fan motor heat.
- SHC values provided are in subcooling mode with the gas bypass valve closed and reflect the maximum SHC in subcooling mode. The P Series innovative modulating valve system can reduce SHC as needed to meet the supply air set point requirement with minimal change in latent capacity. This will provide variable SHC to meet the space load.

Performance data (cont)



COOLING CAPACITIES (cont)

48/50P2,P3,P4,P5055 (55 TON) HIGH-CAPACITY COIL — HOT GAS REHEAT MODE

Temp (F) Air Ent Condenser (Edb)		Air Entering Evaporator — Ewb (F)											
		75 Dry Bulb 62.5 Wet Bulb (50% RH)					75 Dry Bulb 65.3 Wet Bulb (60% RH)						
		Air Entering Evaporator — Cfm											
		11,000	13,750	16,500	19,250	22,000	24,750	11,000	13,750	16,500	19,250	22,000	24,750
80	TC	246	262	271	278	283	287	260	274	285	292	297	302
	SHC	35	58	84	111	138	166	-16	-2	15	33	53	74
	kW	40.8	40.8	40.9	40.9	41.0	41.1	41.6	42.2	41.8	41.8	41.9	41.9
	BF	0.02	0.02	0.03	0.05	0.06	0.07	0.02	0.03	0.04	0.05	0.06	0.07
75	TC	252	266	276	282	287	291	264	279	289	296	302	307
	SHC	40	61	86	113	141	168	-14	0	17	36	56	77
	kW	40.1	39.7	39.8	39.9	40.0	40.0	40.5	40.6	40.7	40.8	40.9	40.9
	BF	0.02	0.02	0.03	0.05	0.06	0.07	0.02	0.03	0.04	0.05	0.06	0.07
70	TC	249	265	272	279	284	287	263	276	285	292	297	301
	SHC	37	64	86	113	140	168	-12	-0	17	36	56	76
	kW	40.6	41.0	40.9	41.0	41.1	41.2	42.0	41.7	41.9	42.0	42.1	42.3
	BF	0.02	0.02	0.03	0.05	0.06	0.07	0.02	0.03	0.04	0.05	0.06	0.07
60	TC	256	270	280	287	294	299	270	283	294	304	310	311
	SHC	42	65	91	118	150	176	-7	4	22	43	63	80
	kW	38.4	38.6	38.9	39.0	39.5	39.6	39.9	39.7	39.9	40.1	40.2	40.3
	BF	0.02	0.02	0.03	0.05	0.06	0.07	0.02	0.02	0.04	0.05	0.06	0.07
50	TC	263	282	290	301	304	311	276	293	308	313	322	327
	SHC	48	73	96	126	152	182	-6	10	29	47	69	83
	kW	36.5	37.0	37.3	37.4	37.7	37.8	37.8	38.1	38.3	38.6	38.6	38.8
	BF	0.02	0.02	0.03	0.05	0.06	0.07	0.02	0.02	0.04	0.05	0.06	0.07
40	TC	272	289	304	309	315	319	288	304	320	324	333	337
	SHC	51	76	100	130	149	187	2	15	31	53	71	95
	kW	35.3	35.7	35.5	36.2	36.8	36.5	36.4	36.7	36.5	37.2	37.6	37.9
	BF	0.02	0.02	0.03	0.05	0.06	0.07	0.02	0.02	0.04	0.05	0.07	0.07

48/50P2,P3,P4,P5055 (55 TON) HIGH-CAPACITY COIL — HOT GAS REHEAT MODE (cont)

Temp (F) Air Ent Condenser (Edb)		Air Entering Evaporator — Ewb (F)											
		75 Dry Bulb 68 Wet Bulb (70% RH)					75 Dry Bulb 70.5 Wet Bulb (80% RH)						
		Air Entering Evaporator — Cfm											
		11,000	13,750	16,500	19,250	22,000	24,750	11,000	13,750	16,500	19,250	22,000	24,750
80	TC	271	289	299	307	313	317	286	301	314	322	329	334
	SHC	-67	-61	-52	-41	-29	-16	-114	-117	-115	-111	-106	-100
	kW	43.3	42.6	42.7	42.8	42.8	42.9	43.6	44.3	43.7	43.7	43.8	43.8
	BF	0.02	0.03	0.04	0.05	0.07	0.08	0.00	0.05	0.06	0.07	0.08	0.10
75	TC	277	296	304	312	318	323	290	306	318	327	333	339
	SHC	-65	-56	-50	-38	-26	-13	-112	-114	-113	-108	-103	-97
	kW	41.6	41.5	41.7	41.7	41.8	41.9	42.6	42.6	42.6	42.7	42.8	42.8
	BF	0.01	0.03	0.04	0.05	0.07	0.08	0.00	0.05	0.06	0.07	0.08	0.10
70	TC	274	291	299	307	312	319	286	302	313	321	328	333
	SHC	-65	-56	-50	-39	-27	-9	-113	-115	-113	-109	-104	-98
	kW	42.7	43.2	43.0	43.1	43.2	43.7	43.8	43.9	44.1	44.2	44.3	44.3
	BF	0.02	0.03	0.04	0.05	0.07	0.08	0.00	0.05	0.06	0.07	0.08	0.10
60	TC	280	296	308	319	325	330	293	310	322	334	340	345
	SHC	-62	-54	-45	-33	-21	-8	-109	-110	-108	-104	-99	-93
	kW	41.1	41.3	41.0	41.1	41.3	41.4	41.7	41.9	42.1	42.2	42.3	42.4
	BF	0.01	0.03	0.04	0.06	0.07	0.08	0.00	0.05	0.06	0.07	0.09	0.10
50	TC	290	308	320	333	338	344	303	322	338	347	354	359
	SHC	-56	-49	-39	-33	-14	-6	-103	-104	-102	-98	-93	-87
	kW	38.9	39.2	39.5	39.0	39.7	39.7	40.1	40.3	40.4	40.6	40.7	40.9
	BF	0.01	0.03	0.04	0.05	0.07	0.08	0.00	0.05	0.06	0.07	0.09	0.10
40	TC	300	319	335	340	349	354	314	337	346	357	364	372
	SHC	-51	-43	-37	-22	-13	0	-98	-103	-97	-96	-90	-81
	kW	37.5	37.7	37.6	38.3	38.7	38.8	38.6	38.3	39.1	39.6	39.9	39.3
	BF	0.01	0.03	0.04	0.05	0.08	0.09	0.00	0.05	0.06	0.08	0.10	0.10

LEGEND

BF — Bypass Factor
Edb — Entering Dry Bulb
Ewb — Entering Wet Bulb
kW — Compressor Motor Power Input
RH — Relative Humidity
SHC — Sensible Heat Cap. (1000 Btu/h)
TC — Total Cap. (1000 Btu/h) Gross

- Correction Factor = $1.10 \times (1 - BF) \times (edb - 75)$.
- Cooling capacities are gross and do not include deduction for indoor fan motor heat.
- Capacity table includes impact of outdoor fan staging at temperatures below 75 F.
- SHC values provided reflect maximum reheat values with 100% gas bypass. Negative SHC value indicates that the air entering the coil is being heated at 100% gas bypass. The P Series innovative modulating valve system will reduce the gas bypass as required to meet the supply air setpoint with minimal change in latent capacity. The space will NOT be overheated and the unit will provide variable SHC to meet the space load.

NOTES:

- The SHC is based on 75 F edb temperature of air entering evaporator coil. For edb temperatures other than 75 F, adjust SHC by multiplying the correction factor and the cfm and then adding or subtracting the value from the SHC.
- Interpolation is permissible.

COOLING CAPACITIES (cont)

48/50P2,P3,P4,P5060 (60 TON) STANDARD CAPACITY COIL — STANDARD MODE

Temp (F) Air Entering Condenser (Edb)		Evaporator Air Quantity — Cfm																			
		12,000					15,000					18,000					21,000				
		Evaporator Air — Ewb (F)																			
		75	72	67	62	57	75	72	67	62	57	75	72	67	62	57	75	72	67	62	57
75	TC	751	718	664	611	558	791	752	698	644	589	816	777	721	667	624	834	796	739	684	653
	SHC	308	339	410	474	530	318	368	449	528	575	335	393	485	577	624	351	415	520	621	653
	kW	43.7	42.9	41.6	40.7	40.4	44.7	43.7	42.4	41.4	40.5	45.4	44.4	43.0	41.9	41.2	45.9	44.8	43.4	42.4	41.7
	BF	0.00	0.00	0.17	0.12	0.11	0.00	0.10	0.16	0.13	0.18	0.00	0.22	0.16	0.14	0.26	0.12	0.21	0.17	0.17	0.33
85	TC	730	701	647	593	539	765	733	679	625	573	787	756	701	647	607	803	773	718	663	636
	SHC	298	334	403	465	518	306	361	442	519	558	326	385	478	568	607	341	407	511	611	636
	kW	48.1	47.4	46.4	46.0	46.0	49.1	48.2	47.3	46.6	45.7	49.7	48.9	47.8	47.0	46.6	50.1	49.3	48.2	47.5	47.0
	BF	0.00	0.00	0.16	0.12	0.12	0.00	0.25	0.15	0.13	0.21	0.00	0.20	0.16	0.14	0.27	0.29	0.20	0.17	0.17	0.35
95	TC	711	681	626	572	515	744	711	656	601	554	764	733	677	622	587	779	748	692	636	616
	SHC	291	327	393	454	498	300	353	432	507	553	319	377	468	556	587	334	399	501	598	616
	kW	53.5	53.0	52.5	52.3	53.8	54.4	53.8	53.3	52.7	53.2	54.9	54.4	53.7	53.3	53.2	55.4	54.8	54.1	53.6	53.1
	BF	0.00	0.00	0.14	0.11	0.14	0.00	0.22	0.15	0.12	0.21	0.13	0.19	0.16	0.14	0.30	0.26	0.19	0.17	0.17	0.37
105	TC	686	655	600	546	489	716	683	627	573	531	735	703	647	591	564	748	717	661	605	591
	SHC	281	317	382	442	484	293	343	420	495	531	310	367	456	541	564	324	388	489	576	591
	kW	60.0	59.8	59.8	61.6	64.9	60.8	60.5	60.5	61.6	63.0	61.3	61.1	60.8	62.3	62.4	61.6	61.4	61.1	62.2	61.8
	BF	0.00	0.12	0.13	0.11	0.14	0.00	0.20	0.14	0.12	0.24	0.30	0.18	0.15	0.15	0.33	0.23	0.19	0.17	0.17	0.39
115	TC	657	624	569	—	—	682	650	594	—	—	700	668	612	554	—	714	681	625	570	562
	SHC	265	306	369	—	—	283	332	407	—	—	299	354	442	522	—	313	376	476	556	562
	kW	67.5	68.0	69.8	—	—	68.1	68.7	70.2	—	—	68.8	69.1	70.3	73.7	—	69.4	69.5	70.4	72.7	72.3
	BF	0.00	0.25	0.12	—	—	0.00	0.18	0.14	—	—	0.24	0.17	0.15	0.15	—	0.22	0.18	0.16	0.20	0.42

48/50P2,P3,P4,P5060 (60 TON) STANDARD CAPACITY COIL — STANDARD MODE (cont)

Temp (F) Air Entering Condenser (Edb)		Evaporator Air Quantity — Cfm									
		24,000				27,000					
		Evaporator Air — Ewb (F)									
		75	72	67	62	57	75	72	67	62	57
75	TC	848	809	752	697	677	861	820	762	707	698
	SHC	365	436	552	660	677	379	456	583	690	698
	kW	46.2	45.2	43.7	42.7	42.2	46.6	45.5	44.0	42.8	42.5
	BF	0.28	0.21	0.19	0.19	0.39	0.26	0.21	0.20	0.23	0.44
85	TC	816	785	730	675	660	829	794	740	686	680
	SHC	356	428	544	648	660	369	447	575	669	680
	kW	50.4	49.7	48.5	47.8	47.2	50.8	49.9	48.8	47.7	47.7
	BF	0.25	0.20	0.18	0.20	0.41	0.25	0.21	0.19	0.25	0.46
95	TC	793	759	704	648	638	803	768	713	660	658
	SHC	348	419	534	630	638	361	439	565	652	658
	kW	55.8	55.1	54.4	53.8	53.5	56.1	55.3	54.6	53.7	53.8
	BF	0.24	0.20	0.18	0.21	0.43	0.24	0.21	0.19	0.26	0.48
105	TC	762	728	671	620	614	771	736	680	632	632
	SHC	338	408	521	605	614	352	427	552	625	632
	kW	62.2	61.7	61.3	61.2	61.4	62.6	62.1	61.5	61.2	61.5
	BF	0.23	0.20	0.18	0.24	0.45	0.23	0.21	0.19	0.28	0.50
115	TC	724	691	635	586	584	732	697	643	602	602
	SHC	327	396	508	581	584	340	415	538	602	602
	kW	69.8	69.5	70.3	71.2	71.7	70.1	69.2	70.4	71.3	71.3
	BF	0.22	0.19	0.18	0.26	0.48	0.22	0.20	0.19	0.31	0.52

LEGEND

48/50P3,P5 units only.

BF — Bypass Factor **kW** — Compressor Motor Power Input
Edb — Entering Dry Bulb **SHC** — Sensible Heat Cap. (1000 Btuh)
Ewb — Entering Wet Bulb **TC** — Total Cap. (1000 Btuh) Gross

NOTES:

- Direct interpolation is permissible. Do not extrapolate.
- The following formulas may be used:

$$t_{db} = t_{edb} - \frac{\text{sensible capacity (Btuh)}}{1.10 \times \text{cfm}}$$

$$t_{lwb} = \text{Wet-bulb temperature corresponding to enthalpy of air leaving evaporator coil } (h_{lwb}).$$

$$h_{lwb} = h_{ewb} - \frac{\text{total capacity (Btuh)}}{4.5 \times \text{cfm}}$$

Where: h_{ewb} = Enthalpy of air entering evaporator coil.

- SHC is based on 80 F edb temperature of air entering evaporator coil. Below 80 F edb, subtract (corr factor x cfm) from SHC. Above 80 F edb, add (corr factor x cfm) to SHC.

BF		ENTERING AIR DRY-BULB TEMP (F)					
		79	78	77	76	75	under 75
		81	82	83	84	85	over 85
		Correction Factor					
.05	1.04	2.09	3.14	4.18	5.22	Use formula shown below	
.10	0.99	1.98	2.97	3.96	4.95		
.20	0.88	1.76	2.64	3.52	4.40		

Interpolation is permissible.
Correction Factor = $1.10 \times (1 - \text{BF}) \times (\text{edb} - 80)$.

- Cooling capacities are gross and do not include deduction for indoor fan motor heat.

Performance data (cont)



COOLING CAPACITIES (cont)

48/50P2,P3,P4,P5060 (60 TON) STANDARD CAPACITY COIL — SUBCOOL MODE

Temp (F) Air Entering Condenser (Edb)		Evaporator Air Quantity — Cfm																			
		12,000					15,000					18,000					21,000				
		Evaporator Air — Ewb (F)																			
		75	72	67	62	57	75	72	67	62	57	75	72	67	62	57	75	72	67	62	57
75	TC	711	674	615	560	508	754	710	650	600	539	771	734	674	626	570	789	758	692	634	599
	SHC	224	268	339	408	473	247	293	379	469	530	255	315	415	522	570	269	344	450	559	599
	KW	48.5	47.7	46.6	45.7	44.8	49.5	48.5	47.2	46.5	45.2	49.9	49.0	47.7	47.1	45.8	50.3	49.7	48.1	47.0	46.3
	BF	0.02	0.08	0.08	0.08	0.09	0.13	0.11	0.10	0.10	0.14	0.15	0.13	0.13	0.12	0.23	0.17	0.16	0.15	0.15	0.31
85	TC	681	646	589	536	482	723	688	622	567	518	746	702	645	589	546	755	717	661	605	586
	SHC	202	246	318	389	446	226	279	357	442	508	239	292	393	492	546	244	311	427	537	586
	KW	52.8	52.0	51.0	50.0	49.2	53.8	53.1	51.6	50.6	49.6	54.3	53.2	52.0	51.0	50.2	54.4	53.5	52.4	51.3	51.6
	BF	0.04	0.08	0.08	0.08	0.08	0.13	0.11	0.10	0.10	0.16	0.15	0.13	0.13	0.12	0.24	0.17	0.16	0.15	0.15	0.32
95	TC	649	615	561	510	462	681	647	592	539	494	703	668	613	560	521	727	684	629	575	548
	SHC	179	224	298	370	435	193	247	335	422	485	206	268	370	470	521	227	288	404	513	548
	KW	57.7	57.0	55.9	55.2	54.8	57.6	57.6	56.5	55.5	54.8	58.9	58.1	56.9	55.9	55.2	59.6	58.4	57.3	56.2	55.7
	BF	0.05	0.08	0.08	0.08	0.10	0.13	0.11	0.10	0.10	0.17	0.15	0.14	0.13	0.13	0.25	0.17	0.16	0.15	0.15	0.33
105	TC	614	582	531	482	433	644	611	559	509	468	664	631	579	528	495	679	646	593	542	519
	SHC	155	201	276	349	408	168	222	312	400	461	180	243	346	447	495	192	262	379	489	519
	KW	63.3	62.6	61.8	61.4	61.3	63.9	63.2	62.1	61.5	61.0	64.4	63.6	62.5	61.7	61.3	64.7	64.0	62.8	61.8	61.5
	BF	0.05	0.08	0.08	0.08	0.09	0.13	0.11	0.10	0.10	0.18	0.15	0.14	0.13	0.13	0.27	0.17	0.16	0.15	0.16	0.34
115	TC	577	547	498	451	408	604	573	524	477	439	631	592	542	494	465	644	605	555	506	489
	SHC	130	177	253	327	381	142	197	288	376	433	162	216	321	422	465	173	235	353	462	489
	KW	69.8	69.3	68.8	68.7	69.0	70.2	69.6	68.9	68.6	68.2	71.0	69.9	69.0	68.5	68.4	71.2	70.1	69.2	68.5	68.4
	BF	0.05	0.08	0.08	0.08	0.12	0.13	0.11	0.10	0.10	0.20	0.15	0.14	0.13	0.13	0.29	0.17	0.16	0.15	0.16	0.36

48/50P2,P3,P4,P5060 (60 TON) STANDARD CAPACITY COIL — SUBCOOL MODE (cont)

Temp (F) Air Entering Condenser (Edb)		Evaporator Air Quantity — Cfm									
		24,000					27,000				
		Evaporator Air — Ewb (F)									
		75	72	67	62	57	75	72	67	62	57
75	TC	793	765	795	775	771	804	774	715	780	778
	SHC	276	357	681	740	771	288	375	514	758	778
	KW	50.4	49.8	50.9	50.6	50.6	50.6	50.0	48.7	50.7	50.7
	BF	0.20	0.18	0.39	0.48	0.63	0.22	0.20	0.18	0.49	0.65
85	TC	776	732	674	617	597	767	742	694	637	617
	SHC	264	333	459	577	597	262	352	495	624	617
	KW	55.1	53.9	52.6	51.5	51.1	54.7	54.2	53.3	52.3	51.5
	BF	0.19	0.18	0.16	0.18	0.38	0.22	0.19	0.18	0.21	0.43
95	TC	730	696	640	586	582	754	704	658	596	601
	SHC	230	307	436	551	582	262	326	475	578	601
	KW	59.5	58.7	57.5	56.4	57.0	61.1	58.8	58.1	56.6	57.3
	BF	0.19	0.18	0.17	0.18	0.39	0.22	0.20	0.18	0.23	0.45
105	TC	698	657	604	553	540	699	666	621	577	570
	SHC	212	281	410	518	540	214	299	449	562	570
	KW	65.4	64.2	63.0	61.9	61.7	65.2	64.4	63.6	63.0	62.9
	BF	0.19	0.18	0.17	0.20	0.41	0.21	0.19	0.18	0.24	0.46
115	TC	654	615	574	519	522	654	623	573	530	524
	SHC	184	254	394	487	522	186	271	414	516	524
	KW	71.5	70.3	69.7	68.5	69.5	71.3	70.5	69.4	68.6	68.6
	BF	0.19	0.18	0.17	0.22	0.42	0.21	0.20	0.18	0.26	0.47

LEGEND

48/50P3,P5 units only.

BF — Bypass Factor **KW** — Compressor Motor Power Input
Edb — Entering Dry Bulb **SHC** — Sensible Heat Cap. (1000 Btuh)
Ewb — Entering Wet Bulb **TC** — Total Cap. (1000 Btuh) Gross

NOTES:

- The SHC is based on 80 F edb temperature of air entering evaporator coil. For edb temperatures other than 80 F, adjust SHC by multiplying the correction factor and the cfm and then adding or subtracting the value from the SHC.

- Interpolation is permissible.
- Correction Factor = $1.10 \times (1 - BF) \times (edb - 80)$.
- Cooling capacities are gross and do not include deduction for indoor fan motor heat.
- SHC values provided are in subcooling mode with the gas bypass valve closed and reflect the maximum SHC in subcooling mode. The P Series innovative modulating valve system can reduce SHC as needed to meet the supply air set point requirement with minimal change in latent capacity. This will provide variable SHC to meet the space load.

COOLING CAPACITIES (cont)

48/50P2,P3,P4,P5060 (60 TON) STANDARD CAPACITY COIL — HOT GAS REHEAT MODE

Temp (F) Air Ent Condenser (Edb)		Air Entering Evaporator — Ewb (F)											
		75 Dry Bulb 62.5 Wet Bulb (50% RH)					75 Dry Bulb 65.3 Wet Bulb (60% RH)						
		Air Entering Evaporator — Cfm											
		12,000	15,000	18,000	21,000	24,000	27,000	12,000	15,000	18,000	21,000	24,000	27,000
80	TC	230	246	257	267	274	279	244	262	274	283	289	294
	SHC	8	34	58	78	102	126	-46	-33	-17	-1	16	34
	kW	49.2	49.7	49.6	48.6	48.6	48.6	49.9	49.6	49.4	49.3	49.3	49.3
	BF	0.08	0.10	0.13	0.15	0.16	0.18	0.08	0.10	0.13	0.15	0.17	0.19
75	TC	236	253	263	274	280	285	250	268	280	289	295	300
	SHC	11	33	55	81	105	129	-43	-30	-14	2	19	37
	kW	47.5	47.2	47.0	47.0	47.1	47.1	48.3	48.0	47.9	47.8	47.8	47.8
	BF	0.08	0.10	0.12	0.15	0.16	0.18	0.08	0.10	0.13	0.15	0.17	0.19
70	TC	236	252	263	270	276	281	249	266	277	285	291	295
	SHC	11	33	56	80	104	128	-43	-30	-15	1	18	35
	kW	48.6	48.5	48.4	48.7	48.5	48.5	49.5	49.3	49.3	49.3	49.3	49.4
	BF	0.08	0.10	0.12	0.15	0.16	0.18	0.08	0.10	0.13	0.15	0.17	0.19
60	TC	245	262	273	281	287	291	259	275	287	295	301	306
	SHC	17	38	61	85	109	133	-38	-25	-10	6	23	40
	kW	45.6	45.5	45.5	45.6	45.7	45.8	46.5	46.4	46.5	46.5	46.6	46.7
	BF	0.08	0.10	0.12	0.15	0.16	0.18	0.08	0.10	0.13	0.15	0.17	0.19
50	TC	253	270	282	290	296	301	267	284	296	305	311	316
	SHC	22	43	66	90	114	138	-33	-20	-5	11	28	45
	kW	43.0	43.0	43.1	43.3	43.4	43.5	44.0	44.1	44.2	44.3	44.4	44.6
	BF	0.08	0.10	0.12	0.14	0.16	0.18	0.08	0.10	0.13	0.15	0.17	0.19
40	TC	261	278	290	299	305	310	275	292	304	314	321	327
	SHC	26	48	71	94	118	142	-28	-16	-1	15	32	50
	kW	40.9	41.0	41.2	41.4	41.6	41.8	42.0	42.1	42.3	42.6	42.8	42.9
	BF	0.08	0.10	0.12	0.14	0.16	0.18	0.08	0.10	0.13	0.15	0.17	0.19

48/50P2,P3,P4,P5060 (60 TON) STANDARD CAPACITY COIL — HOT GAS REHEAT MODE (cont)

Temp (F) Air Ent Condenser (Edb)		Air Entering Evaporator — Ewb (F)											
		75 Dry Bulb 68 Wet Bulb (70% RH)					75 Dry Bulb 70.5 Wet Bulb (80% RH)						
		Air Entering Evaporator — Cfm											
		12,000	15,000	18,000	21,000	24,000	27,000	12,000	15,000	18,000	21,000	24,000	27,000
80	TC	259	277	289	298	304	309	272	291	303	312	318	324
	SHC	-99	-94	-86	-77	-67	-56	-149	-151	-150	-148	-144	-139
	kW	50.7	50.3	50.1	50.1	50.1	50.1	51.6	51.1	51.0	50.9	51.0	51.0
	BF	0.08	0.11	0.13	0.16	0.18	0.19	0.00	0.12	0.15	0.17	0.19	0.21
75	TC	264	282	295	304	310	315	278	296	309	318	325	330
	SHC	-96	-91	-83	-74	-64	-53	-146	-148	-148	-145	-141	-137
	kW	49.1	48.8	48.7	48.6	48.7	48.7	50.0	49.7	49.6	49.6	49.6	49.6
	BF	0.07	0.11	0.13	0.16	0.18	0.19	0.00	0.12	0.15	0.17	0.19	0.21
70	TC	262	279	291	299	305	310	275	292	304	312	318	323
	SHC	-96	-92	-84	-75	-65	-55	-147	-149	-149	-146	-143	-138
	kW	50.5	50.3	50.2	50.3	50.3	50.4	51.5	51.3	51.3	51.3	51.3	51.4
	BF	0.08	0.11	0.13	0.16	0.18	0.19	0.00	0.12	0.15	0.17	0.19	0.21
60	TC	272	289	301	309	315	320	285	302	314	323	329	334
	SHC	-91	-87	-79	-70	-60	-50	-142	-144	-144	-142	-138	-133
	kW	47.6	47.5	47.5	47.6	47.7	47.7	48.7	48.5	48.6	48.7	48.7	48.8
	BF	0.07	0.11	0.13	0.16	0.18	0.19	0.00	0.12	0.15	0.17	0.19	0.21
50	TC	280	298	310	319	325	330	293	311	324	332	339	345
	SHC	-86	-82	-74	-66	-56	-46	-137	-139	-139	-137	-133	-129
	kW	45.2	45.1	45.3	45.4	45.6	45.7	46.3	46.3	46.4	46.6	46.7	46.8
	BF	0.07	0.11	0.13	0.16	0.18	0.19	0.00	0.12	0.15	0.17	0.19	0.21
40	TC	288	306	319	329	337	344	301	320	334	345	353	359
	SHC	-82	-78	-70	-61	-51	-40	-133	-135	-134	-132	-128	-123
	kW	43.2	43.3	43.5	43.7	43.9	44.0	44.4	44.5	44.7	44.9	45.0	45.1
	BF	0.07	0.11	0.13	0.16	0.17	0.19	0.00	0.13	0.15	0.17	0.19	0.21

LEGEND

- | | |
|--|--|
| BF — Bypass Factor | RH — Relative Humidity |
| Edb — Entering Dry Bulb | SHC — Sensible Heat Cap. (1000 Btu/h) |
| Ewb — Entering Wet Bulb | TC — Total Cap. (1000 Btu/h) Gross |
| kW — Compressor Motor Power Input | |

- SHC values provided reflect maximum reheat values with 100% gas bypass. Negative SHC value indicates that the air entering the coil is being heated at 100% gas bypass. The P Series innovative modulating valve system will reduce the gas bypass as required to meet the supply air setpoint with minimal change in latent capacity. The space will NOT be overheated and the unit will provide variable SHC to meet the space load.

NOTES:

- The SHC is based on 75 F edb temperature of air entering evaporator coil. For edb temperatures other than 75 F, adjust SHC by multiplying the correction factor and the cfm and then adding or subtracting the value from the SHC.
- Interpolation is permissible.
- Correction Factor = $1.10 \times (1 - BF) \times (edb - 75)$.
- Cooling capacities are gross and do not include deduction for indoor fan motor heat.
- Capacity table includes impact of outdoor fan staging at temperatures below 75 F.

Performance data (cont)



COOLING CAPACITIES (cont)

48/50P2,P3,P4,P5060 (60 TON) HIGH-CAPACITY COIL — STANDARD MODE

Temp (F) Air Entering Condenser (Edb)		Evaporator Air Quantity — Cfm																			
		12,000					15,000					18,000					21,000				
		Evaporator Air — Ewb (F)																			
		75	72	67	62	57	75	72	67	62	57	75	72	67	62	57	75	72	67	62	57
75	TC	761	725	664	610	561	802	762	700	643	594	830	789	725	666	628	851	809	744	685	659
	SHC	313	349	415	479	539	328	378	457	534	594	347	404	495	588	628	364	426	531	629	659
	kW	43.9	43.0	41.4	40.1	39.0	44.9	43.9	42.3	40.9	39.8	45.5	44.5	42.9	41.4	40.7	46.0	45.0	43.4	42.0	41.3
	BF	0.00	0.00	0.12	0.09	0.08	0.00	0.17	0.12	0.10	0.15	0.10	0.16	0.13	0.11	0.25	0.21	0.17	0.14	0.15	0.33
85	TC	741	705	651	599	549	779	741	685	631	584	808	768	709	656	619	831	788	727	672	647
	SHC	304	342	408	473	525	319	370	450	528	584	340	396	488	580	619	358	418	524	625	647
	kW	48.2	47.3	45.9	44.8	44.1	49.2	48.2	46.8	45.5	44.6	49.9	48.9	47.5	46.3	45.3	50.5	49.4	48.0	46.7	46.0
	BF	0.00	0.09	0.12	0.09	0.09	0.00	0.16	0.12	0.10	0.16	0.25	0.15	0.13	0.12	0.26	0.19	0.17	0.14	0.14	0.34
95	TC	725	690	636	584	534	761	724	668	615	571	787	749	691	637	605	808	766	707	652	633
	SHC	298	336	401	465	520	313	364	443	521	570	333	388	481	571	605	350	410	516	613	633
	kW	53.5	52.6	51.5	50.6	50.3	54.6	53.7	52.5	51.6	50.7	55.5	54.5	53.2	52.3	51.3	56.4	55.1	53.7	52.7	52.0
	BF	0.00	0.07	0.12	0.09	0.11	0.00	0.15	0.12	0.10	0.19	0.21	0.16	0.13	0.12	0.28	0.18	0.16	0.14	0.15	0.35
105	TC	703	669	614	560	508	736	700	643	588	554	760	721	664	610	584	775	736	679	624	611
	SHC	290	328	392	455	498	306	355	432	510	554	324	378	470	556	584	339	400	505	598	611
	kW	60.2	59.4	58.7	57.7	59.7	61.6	60.6	59.7	58.5	57.0	63.1	61.7	60.4	60.2	59.0	64.1	62.4	61.0	60.2	59.6
	BF	0.00	0.06	0.11	0.07	0.11	0.10	0.14	0.11	0.09	0.21	0.19	0.15	0.12	0.13	0.30	0.17	0.16	0.14	0.16	0.38
115	TC	675	639	582	527	482	706	668	610	554	523	—	688	630	574	555	—	—	644	590	582
	SHC	276	316	378	440	476	296	343	419	493	523	—	366	456	540	555	—	—	491	573	582
	kW	70.1	69.7	69.6	68.0	71.2	72.8	70.9	70.6	71.2	70.6	—	72.6	71.6	71.7	70.8	—	—	72.2	71.6	71.3
	BF	0.00	0.15	0.10	0.07	0.16	0.07	0.13	0.11	0.10	0.25	—	0.15	0.12	0.13	0.34	—	—	0.14	0.18	0.41

48/50P2,P3,P4,P5060 (60 TON) HIGH-CAPACITY COIL — STANDARD MODE (cont)

Temp (F) Air Entering Condenser (Edb)		Evaporator Air Quantity — Cfm									
		24,000					27,000				
		Evaporator Air — Ewb (F)									
		75	72	67	62	57	75	72	67	62	57
75	TC	868	824	759	700	684	882	836	770	714	705
	SHC	380	448	565	669	684	393	468	598	689	705
	kW	46.4	45.4	43.8	42.3	42.0	46.7	45.7	44.1	42.7	42.5
	BF	0.19	0.18	0.15	0.18	0.39	0.20	0.19	0.17	0.22	0.44
85	TC	847	803	741	685	671	861	814	752	698	692
	SHC	373	440	558	653	671	387	460	591	688	692
	kW	51.0	49.9	48.3	47.0	46.6	51.5	50.2	48.7	47.3	47.2
	BF	0.18	0.17	0.15	0.20	0.40	0.19	0.18	0.17	0.23	0.45
95	TC	822	780	720	666	656	835	792	730	679	675
	SHC	364	432	550	641	656	377	453	582	664	675
	kW	57.1	55.6	54.1	52.9	52.5	57.9	56.2	54.5	52.9	53.1
	BF	0.19	0.17	0.15	0.20	0.41	0.20	0.18	0.17	0.26	0.46
105	TC	789	749	690	639	633	798	757	699	653	652
	SHC	353	421	538	628	633	365	442	570	648	652
	kW	65.4	63.2	61.4	60.4	60.1	66.8	63.5	61.7	60.5	60.5
	BF	0.18	0.17	0.15	0.21	0.43	0.19	0.17	0.16	0.27	0.48
115	TC	—	—	655	606	603	—	—	663	622	622
	SHC	—	—	524	599	603	—	—	556	622	622
	kW	—	—	72.8	71.0	71.9	—	—	72.8	72.1	72.0
	BF	—	—	0.15	0.24	0.46	—	—	0.16	0.29	0.51

LEGEND

48/50P3,P5 units only.

BF — Bypass Factor **kW** — Compressor Motor Power Input
Edb — Entering Dry Bulb **SHC** — Sensible Heat Cap. (1000 Btuh)
Ewb — Entering Wet Bulb **TC** — Total Cap. (1000 Btuh) Gross

NOTES:

- Direct interpolation is permissible. Do not extrapolate.
- The following formulas may be used:

$$t_{db} = t_{edb} - \frac{\text{sensible capacity (Btuh)}}{1.10 \times \text{cfm}}$$

$$t_{lwb} = \text{Wet-bulb temperature corresponding to enthalpy of air leaving evaporator coil } (h_{lwb}).$$

$$h_{lwb} = h_{ewb} - \frac{\text{total capacity (Btuh)}}{4.5 \times \text{cfm}}$$

Where: h_{ewb} = Enthalpy of air entering evaporator coil.

- SHC is based on 80 F edb temperature of air entering evaporator coil.

Below 80 F edb, subtract (corr factor x cfm) from SHC.
 Above 80 F edb, add (corr factor x cfm) to SHC.

BF	ENTERING AIR DRY-BULB TEMP (F)					
	79	78	77	76	75	under 75
	81	82	83	84	85	over 85
Correction Factor						
.05	1.04	2.09	3.14	4.18	5.22	Use formula shown below
.10	0.99	1.98	2.97	3.96	4.95	
.20	0.88	1.76	2.64	3.52	4.40	

Interpolation is permissible.
 Correction Factor = $1.10 \times (1 - BF) \times (edb - 80)$.

- Cooling capacities are gross and do not include deduction for indoor fan motor heat.

COOLING CAPACITIES (cont)

48/50P2,P3,P4,P5060 (60 TON) HIGH-CAPACITY COIL — SUBCOOL MODE

Temp (F) Air Entering Condenser (Edb)		Evaporator Air Quantity — Cfm																			
		12,000					15,000					18,000					21,000				
		Evaporator Air — Ewb (F)																			
		75	72	67	62	57	75	72	67	62	57	75	72	67	62	57	75	72	67	62	57
75	TC	703	654	591	539	494	787	718	647	570	533	812	750	672	588	558	829	752	683	620	588
	SHC	188	224	299	378	457	254	280	364	435	520	270	312	406	486	558	285	318	439	554	588
	kW	48.9	47.7	46.4	45.3	44.4	50.2	48.9	47.3	45.9	45.1	50.8	49.8	48.0	46.4	45.7	51.3	49.9	48.5	47.0	46.4
	BF	0.00	0.02	0.02	0.02	0.03	0.05	0.04	0.03	0.03	0.08	0.07	0.05	0.04	0.04	0.16	0.09	0.06	0.05	0.06	0.25
85	TC	661	621	559	506	462	691	658	592	534	504	739	692	606	555	526	759	710	639	568	553
	SHC	152	198	273	351	424	163	226	314	405	492	203	261	346	458	526	221	286	402	507	553
	kW	48.9	47.7	46.4	45.3	44.4	50.2	48.9	47.3	45.9	45.1	50.8	49.8	48.0	46.4	45.7	51.3	49.9	48.5	47.0	46.4
	BF	0.03	0.02	0.02	0.02	0.03	0.06	0.03	0.03	0.03	0.09	0.07	0.05	0.04	0.04	0.17	0.08	0.06	0.05	0.06	0.26
95	TC	621	581	522	472	443	672	611	548	497	473	670	625	583	516	492	689	668	581	546	516
	SHC	120	165	242	323	413	154	187	278	375	462	142	203	331	426	492	159	254	352	490	516
	kW	57.4	56.5	55.3	54.4	54.1	58.4	57.2	55.8	54.8	54.2	58.7	57.6	56.4	55.2	54.7	59.2	58.4	56.6	55.6	55.1
	BF	0.02	0.02	0.02	0.02	0.05	0.05	0.03	0.03	0.03	0.11	0.07	0.05	0.04	0.04	0.19	0.08	0.06	0.05	0.07	0.27
105	TC	576	538	483	436	410	628	564	505	458	441	625	586	521	474	457	644	597	534	493	478
	SHC	87	132	212	294	378	122	151	244	344	432	110	174	280	393	457	127	193	315	440	478
	kW	62.9	62.0	61.0	60.8	61.0	64.0	62.6	61.2	60.6	60.4	64.2	63.1	61.6	60.6	60.5	64.7	63.4	61.8	60.9	60.6
	BF	0.02	0.02	0.02	0.02	0.05	0.05	0.03	0.03	0.03	0.12	0.07	0.05	0.04	0.05	0.20	0.08	0.06	0.05	0.09	0.28
115	TC	529	493	440	396	379	553	514	459	415	400	573	530	473	432	420	587	544	482	451	438
	SHC	52	99	180	265	349	60	113	210	312	387	74	133	243	361	420	86	155	276	400	438
	kW	69.6	68.7	68.2	68.7	69.0	70.1	69.0	68.0	68.0	68.4	70.7	69.3	68.0	67.7	67.8	71.2	69.6	68.1	67.5	67.6
	BF	0.02	0.02	0.02	0.02	0.07	0.05	0.03	0.03	0.03	0.13	0.07	0.05	0.04	0.05	0.22	0.08	0.06	0.05	0.11	0.30

48/50P2,P3,P4,P5060 (60 TON) HIGH-CAPACITY COIL — SUBCOOL MODE (cont)

Temp (F) Air Entering Condenser (Edb)		Evaporator Air Quantity — Cfm									
		24,000					27,000				
		Evaporator Air — Ewb (F)									
		75	72	67	62	57	75	72	67	62	57
75	TC	847	805	691	637	607	859	791	720	662	654
	SHC	301	384	471	599	607	321	379	526	638	654
	kW	51.7	50.8	48.6	47.4	46.9	52.1	50.7	49.1	47.8	47.6
	BF	0.10	0.08	0.07	0.10	0.32	0.11	0.09	0.08	0.14	0.38
85	TC	776	725	651	591	574	795	737	662	601	599
	SHC	239	312	440	552	574	261	337	478	584	599
	kW	55.3	54.2	52.5	51.2	50.9	55.9	54.5	52.8	51.5	51.5
	BF	0.10	0.08	0.07	0.11	0.33	0.11	0.09	0.08	0.15	0.39
95	TC	701	683	609	550	535	747	694	619	561	554
	SHC	173	279	407	513	535	225	304	443	546	554
	kW	59.6	58.8	57.1	55.8	55.5	60.3	59.1	57.3	56.1	56.0
	BF	0.09	0.08	0.07	0.12	0.34	0.11	0.09	0.08	0.16	0.40
105	TC	656	610	544	509	495	667	618	550	519	512
	SHC	141	218	351	474	495	156	238	385	505	512
	kW	65.1	63.7	62.1	61.2	61.0	65.4	64.0	62.3	61.4	61.3
	BF	0.09	0.07	0.07	0.13	0.35	0.11	0.09	0.08	0.17	0.41
115	TC	599	553	491	465	453	609	561	498	471	466
	SHC	100	175	311	432	453	115	197	346	460	466
	kW	71.7	69.9	68.2	67.6	67.5	72.1	70.1	68.3	67.7	67.6
	BF	0.09	0.07	0.07	0.15	0.37	0.11	0.09	0.08	0.19	0.42

LEGEND

48/50P3,P5 units only.

BF — Bypass Factor **kW** — Compressor Motor Power Input
Edb — Entering Dry Bulb **SHC** — Sensible Heat Cap. (1000 Btuh)
Ewb — Entering Wet Bulb **TC** — Total Cap. (1000 Btuh) Gross

NOTES:

- The SHC is based on 80 F edb temperature of air entering evaporator coil. For edb temperatures other than 80 F, adjust SHC by multiplying the correction factor and the cfm and then adding or subtracting the value from the SHC.

- Interpolation is permissible.
- Correction Factor = $1.10 \times (1 - BF) \times (edb - 80)$.
- Cooling capacities are gross and do not include deduction for indoor fan motor heat.
- SHC values provided are in subcooling mode with the gas bypass valve closed and reflect the maximum SHC in subcooling mode. The P Series innovative modulating valve system can reduce SHC as needed to meet the supply air set point requirement with minimal change in latent capacity. This will provide variable SHC to meet the space load.

Performance data (cont)



COOLING CAPACITIES (cont)

48/50P2,P3,P4,P5060 (60 TON) HIGH-CAPACITY COIL — HOT GAS REHEAT MODE

Temp (F) Air Ent Condenser (Edb)		Air Entering Evaporator — Ewb (F)											
		75 Dry Bulb 62.5 Wet Bulb (50% RH)					75 Dry Bulb 65.3 Wet Bulb (60% RH)						
		Air Entering Evaporator — Cfm											
		12,000	15,000	18,000	21,000	24,000	27,000	12,000	15,000	18,000	21,000	24,000	27,000
80	TC	269	287	298	306	312	316	285	302	314	322	328	332
	SHC	34	60	87	116	145	174	-20	-7	11	31	52	73
	kW	47.5	47.1	47.2	47.3	47.5	47.6	47.8	48.2	48.3	48.5	48.6	48.7
	BF	0.02	0.03	0.04	0.05	0.06	0.08	0.02	0.03	0.04	0.05	0.07	0.08
75	TC	275	292	303	311	316	321	288	307	318	326	332	337
	SHC	38	63	90	118	148	177	-20	-4	14	34	55	77
	kW	45.5	45.7	45.9	46.1	46.3	46.4	47.5	46.9	47.1	47.3	47.4	47.5
	BF	0.02	0.03	0.04	0.05	0.06	0.08	0.02	0.03	0.04	0.05	0.07	0.08
70	TC	269	288	299	306	312	316	286	302	313	321	327	331
	SHC	33	62	89	117	147	176	-20	-5	13	33	54	76
	kW	47.6	47.3	47.5	47.8	48.0	48.1	48.4	48.6	48.8	49.1	49.3	49.4
	BF	0.02	0.03	0.04	0.05	0.06	0.08	0.02	0.03	0.04	0.05	0.07	0.08
60	TC	279	296	307	314	320	324	294	310	321	329	335	340
	SHC	41	66	94	123	150	179	-15	-0	18	38	56	78
	kW	45.0	44.8	45.2	45.4	45.7	45.8	45.8	46.1	46.5	46.7	47.0	47.1
	BF	0.02	0.03	0.04	0.05	0.07	0.08	0.02	0.03	0.04	0.05	0.07	0.08
50	TC	286	303	315	324	331	336	300	319	332	340	348	353
	SHC	46	71	99	126	156	185	-11	5	21	44	61	83
	kW	42.3	42.9	43.3	43.6	43.8	44.0	43.7	44.2	44.6	45.0	45.1	45.3
	BF	0.02	0.03	0.04	0.05	0.07	0.08	0.02	0.03	0.04	0.05	0.07	0.08
40	TC	304	324	327	336	343	349	321	330	343	353	360	365
	SHC	56	82	103	132	161	191	-1	10	27	47	68	91
	kW	39.0	39.6	41.6	42.0	42.3	42.4	40.4	42.6	43.0	43.3	43.6	44.2
	BF	0.02	0.03	0.04	0.05	0.07	0.08	0.02	0.03	0.04	0.06	0.07	0.08

48/50P2,P3,P4,P5060 (60 TON) HIGH-CAPACITY COIL — HOT GAS REHEAT MODE (cont)

Temp (F) Air Ent Condenser (Edb)		Air Entering Evaporator — Ewb (F)											
		75 Dry Bulb 68 Wet Bulb (70% RH)					75 Dry Bulb 70.5 Wet Bulb (80% RH)						
		Air Entering Evaporator — Cfm											
		12,000	15,000	18,000	21,000	24,000	27,000	12,000	15,000	18,000	21,000	24,000	27,000
80	TC	300	317	329	338	344	350	314	332	345	354	361	367
	SHC	-77	-72	-63	-51	-39	-25	-130	-133	-132	-128	-123	-116
	kW	49.2	49.3	49.5	49.6	49.8	49.8	50.5	50.6	50.7	50.8	50.9	51.0
	BF	0.02	0.03	0.05	0.06	0.07	0.09	0.00	0.05	0.06	0.08	0.09	0.10
75	TC	304	322	334	342	349	354	318	337	349	359	366	372
	SHC	-75	-69	-60	-49	-35	-22	-128	-131	-129	-126	-120	-114
	kW	47.9	48.1	48.3	48.5	48.6	48.7	49.2	49.4	49.5	49.7	49.8	49.9
	BF	0.01	0.03	0.05	0.06	0.07	0.09	0.00	0.05	0.06	0.08	0.09	0.10
70	TC	300	317	328	336	343	347	313	331	343	352	359	364
	SHC	-76	-70	-61	-50	-37	-25	-129	-132	-130	-127	-121	-115
	kW	49.6	49.9	50.2	50.4	50.6	50.8	51.0	51.3	51.5	51.8	51.9	52.1
	BF	0.02	0.03	0.05	0.06	0.07	0.09	0.00	0.05	0.06	0.08	0.09	0.10
60	TC	307	325	336	345	351	357	321	339	352	361	368	373
	SHC	-72	-66	-56	-48	-35	-22	-124	-127	-126	-125	-120	-114
	kW	47.2	47.5	47.9	48.2	48.4	48.5	48.6	48.9	49.2	49.6	49.8	50.0
	BF	0.01	0.03	0.05	0.06	0.08	0.09	0.00	0.05	0.06	0.08	0.10	0.11
50	TC	315	334	348	357	364	370	330	350	364	374	381	387
	SHC	-67	-60	-54	-38	-30	-17	-120	-121	-123	-120	-115	-108
	kW	45.2	45.6	46.0	46.3	46.5	46.7	46.6	47.0	47.4	47.6	47.8	47.9
	BF	0.01	0.03	0.05	0.06	0.08	0.09	0.00	0.05	0.07	0.08	0.10	0.11
40	TC	325	346	360	370	378	384	340	362	376	387	395	402
	SHC	-62	-54	-47	-36	-23	-10	-117	-119	-118	-114	-109	-102
	kW	43.5	44.1	44.4	44.6	44.8	45.0	45.0	45.4	45.7	45.9	46.1	46.3
	BF	0.01	0.03	0.05	0.06	0.08	0.09	0.00	0.05	0.07	0.08	0.10	0.11

LEGEND

BF — Bypass Factor
Edb — Entering Dry Bulb
Ewb — Entering Wet Bulb
kW — Compressor Motor Power Input
RH — Relative Humidity
SHC — Sensible Heat Cap. (1000 Btu/h)
TC — Total Cap. (1000 Btu/h) Gross

- Correction Factor = $1.10 \times (1 - BF) \times (edb - 75)$.
- Cooling capacities are gross and do not include deduction for indoor fan motor heat.
- Capacity table includes impact of outdoor fan staging at temperatures below 75 F.
- SHC values provided reflect maximum reheat values with 100% gas bypass. Negative SHC value indicates that the air entering the coil is being heated at 100% gas bypass. The P Series innovative modulating valve system will reduce the gas bypass as required to meet the supply air setpoint with minimal change in latent capacity. The space will NOT be overheated and the unit will provide variable SHC to meet the space load.

NOTES:

- The SHC is based on 75 F edb temperature of air entering evaporator coil. For edb temperatures other than 75 F, adjust SHC by multiplying the correction factor and the cfm and then adding or subtracting the value from the SHC.
- Interpolation is permissible.

COOLING CAPACITIES (cont)

48/50P2,P3,P4,P5070 (70 TON) STANDARD CAPACITY COIL — STANDARD MODE

Temp (F) Air Entering Condenser (Edb)		Evaporator Air Quantity — Cfm																			
		14,000					17,500					21,000					24,500				
		Evaporator Air — Ewb (F)																			
		75	72	67	62	57	75	72	67	62	57	75	72	67	62	57	75	72	67	62	57
75	TC	843	802	744	685	629	880	839	779	720	675	905	863	803	744	710	924	882	820	761	741
	SHC	345	392	472	549	604	363	423	520	614	663	384	453	564	672	710	402	479	606	722	741
	kW	46.7	45.7	44.2	42.9	41.9	47.7	46.6	45.0	43.7	42.7	48.4	47.3	45.6	44.3	43.5	48.9	47.7	46.1	44.7	44.2
	BF	0.00	0.19	0.09	0.07	0.11	0.00	0.14	0.10	0.08	0.20	0.21	0.12	0.11	0.10	0.27	0.17	0.13	0.12	0.13	0.35
85	TC	822	783	726	667	612	857	819	759	700	655	880	839	782	722	694	900	860	798	739	724
	SHC	334	384	464	540	599	356	416	511	604	655	376	444	555	660	694	394	471	597	709	724
	kW	51.3	50.2	48.9	47.7	46.8	52.2	51.2	49.7	48.5	47.6	52.9	51.8	50.3	49.1	48.3	53.4	52.3	50.8	49.5	49.0
	BF	0.00	0.17	0.09	0.07	0.11	0.00	0.13	0.10	0.08	0.20	0.19	0.12	0.11	0.11	0.29	0.16	0.13	0.12	0.14	0.36
95	TC	799	763	703	645	588	830	791	734	674	635	854	816	755	695	673	871	832	771	711	702
	SHC	326	376	454	531	584	347	406	501	591	635	367	435	545	647	673	385	461	586	688	702
	kW	56.7	55.8	54.6	53.2	52.7	57.6	56.5	55.4	54.3	53.4	58.3	57.4	55.9	54.8	54.1	58.9	57.9	56.4	55.1	54.8
	BF	0.00	0.15	0.09	0.06	0.11	0.27	0.11	0.09	0.08	0.22	0.17	0.12	0.10	0.11	0.31	0.16	0.13	0.12	0.15	0.38
105	TC	771	734	674	618	569	799	764	703	644	612	821	784	722	664	648	836	798	737	679	676
	SHC	313	365	442	517	561	337	395	488	577	612	356	424	531	631	648	374	449	573	672	676
	kW	63.1	62.3	61.1	60.4	60.1	64.0	63.2	62.0	61.8	61.1	64.8	63.8	62.5	62.0	61.4	65.3	64.4	62.9	62.0	61.8
	BF	0.00	0.13	0.07	0.06	0.15	0.20	0.11	0.09	0.08	0.25	0.15	0.11	0.10	0.11	0.34	0.15	0.13	0.11	0.16	0.41
115	TC	736	699	642	587	541	763	728	669	610	587	782	747	687	629	620	796	760	700	650	646
	SHC	304	353	427	503	541	325	383	474	560	587	344	411	517	602	620	361	435	559	641	646
	kW	70.7	69.4	70.3	69.2	71.0	71.7	71.3	70.8	71.4	70.3	72.5	72.1	71.4	71.1	71.0	73.0	72.4	71.7	70.8	71.1
	BF	0.00	0.10	0.08	0.05	0.17	0.16	0.10	0.09	0.09	0.28	0.14	0.11	0.10	0.14	0.37	0.14	0.13	0.11	0.20	0.43

48/50P2,P3,P4,P5070 (70 TON) STANDARD CAPACITY COIL — STANDARD MODE (cont)

Temp (F) Air Entering Condenser (Edb)		Evaporator Air Quantity — Cfm									
		28,000					30,000				
		Evaporator Air — Ewb (F)									
		75	72	67	62	57	75	72	67	62	57
75	TC	938	897	834	774	767	945	903	840	782	779
	SHC	419	504	646	758	767	428	518	668	776	779
	kW	49.3	48.1	46.4	45.0	44.8	49.5	48.3	46.6	45.1	45.1
	BF	0.17	0.15	0.13	0.18	0.41	0.17	0.15	0.14	0.21	0.44
85	TC	913	874	811	751	749	919	880	816	763	761
	SHC	411	496	637	745	749	420	510	659	756	761
	kW	53.8	52.8	51.1	49.7	49.6	54.0	52.9	51.3	50.0	49.9
	BF	0.16	0.14	0.13	0.18	0.43	0.16	0.15	0.14	0.23	0.45
95	TC	883	845	782	728	726	889	850	788	741	738
	SHC	401	486	626	723	726	411	500	648	727	738
	kW	59.3	58.3	56.7	55.4	55.4	59.5	58.4	56.9	55.7	55.7
	BF	0.16	0.14	0.13	0.21	0.44	0.16	0.15	0.14	0.27	0.47
105	TC	847	809	747	701	698	853	815	753	710	710
	SHC	390	474	615	692	698	400	488	635	710	710
	kW	65.7	64.7	63.1	62.1	62.2	65.9	64.9	63.4	62.4	62.4
	BF	0.15	0.14	0.12	0.24	0.46	0.15	0.14	0.14	0.27	0.49
115	TC	806	770	710	673	668	811	774	714	680	679
	SHC	378	460	598	655	668	387	474	619	680	679
	kW	73.5	72.8	71.9	71.1	71.2	73.7	72.9	72.2	71.3	71.4
	BF	0.14	0.14	0.13	0.29	0.49	0.15	0.14	0.14	0.30	0.51

LEGEND

48/50P3,P5 units only.

BF — Bypass Factor **kW** — Compressor Motor Power Input
Edb — Entering Dry Bulb **SHC** — Sensible Heat Cap. (1000 Btuh)
Ewb — Entering Wet Bulb **TC** — Total Cap. (1000 Btuh) Gross

NOTES:

- Direct interpolation is permissible. Do not extrapolate.
- The following formulas may be used:

$$t_{db} = t_{edb} - \frac{\text{sensible capacity (Btuh)}}{1.10 \times \text{cfm}}$$

$$t_{lwb} = \text{Wet-bulb temperature corresponding to enthalpy of air leaving evaporator coil } (h_{lwb}).$$

$$h_{lwb} = h_{ewb} - \frac{\text{total capacity (Btuh)}}{4.5 \times \text{cfm}}$$

Where: h_{ewb} = Enthalpy of air entering evaporator coil.

- SHC is based on 80 F edb temperature of air entering evaporator coil.
Below 80 F edb, subtract (corr factor x cfm) from SHC.
Above 80 F edb, add (corr factor x cfm) to SHC.

		ENTERING AIR DRY-BULB TEMP (F)					
		79	78	77	76	75	under 75
BF	81	82	83	84	85	over 85	
	Correction Factor						
.05	1.04	2.09	3.14	4.18	5.22	Use formula shown below	
.10	0.99	1.98	2.97	3.96	4.95		
.20	0.88	1.76	2.64	3.52	4.40		

Interpolation is permissible.
Correction Factor = $1.10 \times (1 - \text{BF}) \times (\text{edb} - 80)$.

- Cooling capacities are gross and do not include deduction for indoor fan motor heat.

Performance data (cont)



COOLING CAPACITIES (cont)

48/50P2,P3,P4,P5070 (70 TON) STANDARD CAPACITY COIL — SUBCOOL MODE

Temp (F) Air Entering Condenser (Edb)		Evaporator Air Quantity — Cfm																			
		14,000					17,500					21,000					24,500				
		Evaporator Air — Ewb (F)																			
		75	72	67	62	57	75	72	67	62	57	75	72	67	62	57	75	72	67	62	57
75	TC	791	754	683	644	576	812	787	726	676	627	855	813	749	671	663	875	813	767	703	681
	SHC	255	309	393	488	552	257	336	440	549	627	292	363	483	580	663	308	369	525	648	681
	kW	52.2	51.2	49.8	48.8	47.5	53.0	52.1	50.6	49.5	48.6	54.3	53.1	51.2	49.6	49.3	54.8	53.1	51.7	50.4	49.6
	BF	0.00	0.07	0.07	0.06	0.08	0.13	0.10	0.09	0.09	0.16	0.14	0.12	0.11	0.11	0.26	0.16	0.14	0.13	0.14	0.34
85	TC	738	724	665	618	551	774	738	695	637	588	815	776	716	668	623	833	793	731	672	675
	SHC	209	286	374	467	529	229	295	416	517	588	264	337	458	584	623	279	361	497	624	675
	kW	56.1	55.5	54.1	53.2	51.8	57.2	56.2	54.9	53.6	52.5	58.4	57.3	55.4	54.3	53.3	59.0	57.8	56.1	54.7	55.7
	BF	0.00	0.07	0.07	0.07	0.09	0.13	0.10	0.09	0.09	0.17	0.14	0.12	0.11	0.11	0.27	0.15	0.14	0.13	0.14	0.35
95	TC	723	687	627	595	543	754	718	660	579	577	775	739	681	646	616	791	753	696	639	621
	SHC	205	258	344	453	522	221	285	390	467	577	236	310	431	571	616	250	333	472	597	621
	kW	61.7	60.7	59.2	59.7	59.3	62.6	61.6	60.1	58.3	59.8	63.3	62.2	60.6	60.7	60.4	63.8	62.7	61.1	59.6	59.2
	BF	0.05	0.07	0.07	0.07	0.11	0.13	0.10	0.09	0.09	0.17	0.14	0.12	0.11	0.11	0.28	0.15	0.14	0.13	0.15	0.36
105	TC	685	650	605	565	517	714	679	624	593	552	733	699	643	613	586	747	713	657	604	589
	SHC	178	232	333	431	498	193	257	364	491	552	207	282	405	547	586	221	305	444	560	589
	kW	67.3	66.4	65.9	65.7	65.5	68.2	67.2	65.8	64.6	65.9	68.8	67.8	66.3	66.7	66.6	69.3	68.2	66.7	65.3	64.9
	BF	0.05	0.07	0.07	0.07	0.12	0.13	0.10	0.09	0.09	0.20	0.14	0.12	0.11	0.12	0.30	0.15	0.14	0.13	0.17	0.37
115	TC	643	610	583	532	483	670	637	584	558	522	705	655	602	576	555	718	668	615	567	554
	SHC	150	205	321	408	471	163	229	337	467	522	195	253	377	522	555	209	275	416	526	554
	kW	73.7	72.8	73.4	72.9	72.7	74.5	73.6	72.2	73.1	73.1	75.9	74.1	72.7	73.5	73.5	76.3	74.5	73.0	71.7	71.4
	BF	0.04	0.07	0.07	0.07	0.15	0.12	0.10	0.09	0.09	0.22	0.14	0.12	0.11	0.12	0.32	0.15	0.14	0.13	0.19	0.39

48/50P2,P3,P4,P5070 (70 TON) STANDARD CAPACITY COIL — SUBCOOL MODE (cont)

Temp (F) Air Entering Condenser (Edb)		Evaporator Air Quantity — Cfm									
		28,000					30,000				
		Evaporator Air — Ewb (F)									
		75	72	67	62	57	75	72	67	62	57
75	TC	703	888	847	777	717	897	854	783	696	728
	SHC	648	332	414	561	717	333	428	582	681	728
	kW	50.4	55.2	54.1	52.3	50.5	55.5	54.3	52.5	50.4	50.8
	BF	0.17	0.15	0.14	0.17	0.40	0.18	0.16	0.15	0.20	0.43
85	TC	847	806	744	683	675	853	812	750	715	709
	SHC	294	385	536	657	675	303	399	558	700	709
	kW	59.4	58.2	56.5	54.9	54.7	59.6	58.4	56.7	56.9	56.3
	BF	0.17	0.15	0.14	0.19	0.41	0.18	0.16	0.15	0.22	0.44
95	TC	802	766	707	677	669	808	771	713	685	608
	SHC	265	357	510	654	669	273	370	531	674	608
	kW	64.2	63.1	61.4	61.5	61.3	64.4	63.3	61.6	61.8	59.2
	BF	0.17	0.15	0.14	0.20	0.42	0.18	0.16	0.15	0.23	0.45
105	TC	758	724	668	643	635	763	729	672	652	646
	SHC	235	328	482	623	635	242	341	503	643	646
	kW	69.7	68.6	67.0	67.5	67.4	69.8	68.8	67.2	67.8	67.6
	BF	0.17	0.15	0.14	0.22	0.43	0.18	0.16	0.15	0.24	0.46
115	TC	711	697	624	581	573	738	701	629	587	610
	SHC	204	318	453	561	573	235	331	474	580	610
	kW	75.9	75.7	73.3	72.1	71.9	77.0	75.9	73.5	72.3	74.3
	BF	0.17	0.15	0.14	0.23	0.45	0.18	0.16	0.15	0.26	0.48

LEGEND

48/50P3,P5 units only.

BF — Bypass Factor **kW** — Compressor Motor Power Input
Edb — Entering Dry Bulb **SHC** — Sensible Heat Cap. (1000 Btuh)
Ewb — Entering Wet Bulb **TC** — Total Cap. (1000 Btuh) Gross

NOTES:

- The SHC is based on 80 F edb temperature of air entering evaporator coil. For edb temperatures other than 80 F, adjust SHC by multiplying the correction factor and the cfm and then adding or subtracting the value from the SHC.

- Interpolation is permissible.
- Correction Factor = $1.10 \times (1 - BF) \times (edb - 80)$.
- Cooling capacities are gross and do not include deduction for indoor fan motor heat.
- SHC values provided are in subcooling mode with the gas bypass valve closed and reflect the maximum SHC in subcooling mode. The P Series innovative modulating valve system can reduce SHC as needed to meet the supply air set point requirement with minimal change in latent capacity. This will provide variable SHC to meet the space load.

COOLING CAPACITIES (cont)

48/50P2,P3,P4,P5070 (70 TON) STANDARD CAPACITY COIL — HOT GAS REHEAT MODE

Temp (F) Air Ent Condenser (Edb)		Air Entering Evaporator — Ewb (F)											
		75 Dry Bulb 62.5 Wet Bulb (50% RH)					75 Dry Bulb 65.3 Wet Bulb (60% RH)						
		Air Entering Evaporator — Cfm											
		14,000	17,500	21,000	24,500	28,000	30,000	14,000	17,500	21,000	24,500	28,000	30,000
80	TC	258	276	287	296	301	304	274	292	303	311	317	320
	SHC	19	47	77	107	138	155	-43	-25	-5	16	38	51
	kW	54.3	54.0	53.9	53.9	53.9	53.9	55.0	54.7	54.6	54.6	54.7	54.7
	BF	0.07	0.09	0.11	0.13	0.15	0.16	0.07	0.09	0.11	0.13	0.15	0.16
75	TC	265	283	294	302	308	311	280	298	310	318	325	327
	SHC	23	51	80	111	141	158	-40	-22	-2	20	41	54
	kW	52.5	52.3	52.2	52.2	52.2	52.2	53.2	53.1	53.0	53.0	53.0	53.0
	BF	0.07	0.09	0.11	0.13	0.15	0.16	0.07	0.09	0.11	0.13	0.15	0.16
70	TC	271	288	300	309	315	318	286	304	316	325	331	334
	SHC	26	54	84	114	144	162	-36	-19	2	23	44	57
	kW	50.9	50.8	50.6	50.7	50.7	50.7	51.7	51.5	51.4	51.6	51.6	51.6
	BF	0.07	0.09	0.11	0.13	0.15	0.16	0.07	0.09	0.11	0.13	0.15	0.16
60	TC	268	284	294	301	307	309	282	298	308	316	321	324
	SHC	26	54	83	112	142	159	-37	-20	0	21	42	55
	kW	51.9	51.9	52.1	52.2	52.4	52.4	52.9	53.1	53.1	53.3	53.4	53.5
	BF	0.07	0.09	0.11	0.13	0.15	0.16	0.07	0.09	0.11	0.13	0.15	0.16
50	TC	278	295	305	313	319	321	293	309	320	328	333	336
	SHC	33	60	89	119	149	166	-30	-13	6	27	49	61
	kW	48.9	49.0	49.2	49.4	49.6	49.7	50.0	50.2	50.4	50.6	50.7	50.8
	BF	0.07	0.09	0.11	0.13	0.15	0.16	0.07	0.09	0.11	0.13	0.15	0.16
40	TC	286	304	315	322	328	331	301	318	329	338	345	349
	SHC	38	65	94	124	154	171	-25	-8	12	33	55	67
	kW	46.4	46.6	46.9	47.2	47.4	47.5	47.6	47.8	48.1	48.4	48.7	48.8
	BF	0.07	0.09	0.11	0.13	0.15	0.16	0.07	0.09	0.11	0.13	0.15	0.16

48/50P2,P3,P4,P5070 (70 TON) STANDARD CAPACITY COIL — HOT GAS REHEAT MODE (cont)

Temp (F) Air Ent Condenser (Edb)		Air Entering Evaporator — Ewb (F)											
		75 Dry Bulb 68 Wet Bulb (70% RH)					75 Dry Bulb 70.5 Wet Bulb (80% RH)						
		Air Entering Evaporator — Cfm											
		14,000	17,500	21,000	24,500	28,000	30,000	14,000	17,500	21,000	24,500	28,000	30,000
80	TC	289	307	319	327	333	336	303	321	333	342	348	351
	SHC	-105	-97	-86	-73	-59	-51	-162	-163	-160	-156	-149	-145
	kW	55.8	55.6	55.5	55.5	55.5	55.5	56.8	56.6	56.4	56.5	56.6	56.6
	BF	0.07	0.10	0.12	0.14	0.16	0.17	0.02	0.12	0.14	0.15	0.17	0.18
75	TC	296	314	326	334	340	344	310	328	340	350	357	361
	SHC	-101	-93	-82	-70	-56	-48	-159	-159	-157	-152	-145	-141
	kW	54.1	53.9	53.9	54.0	54.0	54.0	55.2	54.9	54.9	55.0	55.0	55.1
	BF	0.07	0.10	0.12	0.14	0.16	0.17	0.02	0.12	0.14	0.15	0.17	0.18
70	TC	302	320	332	341	349	352	316	334	348	358	366	370
	SHC	-98	-90	-79	-66	-52	-44	-155	-156	-153	-148	-142	-137
	kW	52.6	52.5	52.4	52.5	52.6	52.6	53.7	53.5	53.5	53.6	53.6	53.7
	BF	0.07	0.10	0.12	0.14	0.16	0.17	0.02	0.12	0.14	0.15	0.17	0.18
60	TC	296	312	322	330	335	338	308	325	335	343	349	351
	SHC	-99	-91	-80	-68	-55	-47	-156	-158	-156	-151	-145	-141
	kW	54.2	54.2	54.3	54.5	54.7	54.7	55.5	55.5	55.7	55.8	55.9	56.0
	BF	0.07	0.10	0.12	0.14	0.16	0.17	0.02	0.12	0.14	0.15	0.17	0.18
50	TC	306	323	334	342	348	351	319	337	348	356	363	367
	SHC	-92	-84	-74	-62	-48	-40	-150	-151	-149	-144	-138	-134
	kW	51.3	51.4	51.6	51.8	52.0	52.1	52.6	52.7	52.9	53.1	53.4	53.4
	BF	0.07	0.10	0.12	0.14	0.16	0.17	0.02	0.12	0.14	0.15	0.17	0.18
40	TC	315	333	345	355	362	366	329	348	361	371	379	382
	SHC	-87	-79	-68	-55	-42	-34	-144	-145	-142	-137	-131	-127
	kW	48.9	49.1	49.5	49.8	50.0	50.1	50.3	50.6	50.9	51.2	51.4	51.5
	BF	0.07	0.10	0.12	0.14	0.16	0.17	0.03	0.12	0.14	0.16	0.17	0.18

LEGEND

BF — Bypass Factor **RH** — Relative Humidity
Edb — Entering Dry Bulb **SHC** — Sensible Heat Cap. (1000 Btu/h)
Ewb — Entering Wet Bulb **TC** — Total Cap. (1000 Btu/h) Gross
kW — Compressor Motor Power
 Input

6. SHC values provided reflect maximum reheat values with 100% gas bypass. Negative SHC value indicates that the air entering the coil is being heated at 100% gas bypass. The P Series innovative modulating valve system will reduce the gas bypass as required to meet the supply air setpoint with minimal change in latent capacity. The space will NOT be overheated and the unit will provide variable SHC to meet the space load.

NOTES:

1. The SHC is based on 75 F edb temperature of air entering evaporator coil. For edb temperatures other than 75 F, adjust SHC by multiplying the correction factor and the cfm and then adding or subtracting the value from the SHC.
2. Interpolation is permissible.
3. Correction Factor = 1.10 x (1 - BF) x (edb - 75).
4. Cooling capacities are gross and do not include deduction for indoor fan motor heat.
5. Capacity table includes impact of outdoor fan staging at temperatures below 75 F.

Performance data (cont)



COOLING CAPACITIES (cont)

48/50P2,P3,P4,P5070 (70 TON) HIGH-CAPACITY COIL — STANDARD MODE

Temp (F) Air Entering Condenser (Edb)		Evaporator Air Quantity — Cfm																			
		14,000					17,500					21,000					24,500				
		Evaporator Air — Ewb (F)																			
		75	72	67	62	57	75	72	67	62	57	75	72	67	62	57	75	72	67	62	57
75	TC	863	814	754	690	636	905	862	793	728	686	934	889	820	753	729	956	911	839	771	764
	SHC	353	404	485	563	630	380	441	539	635	686	403	473	589	700	729	423	504	639	757	764
	kW	47.8	46.6	44.8	43.2	42.0	48.8	47.6	45.7	44.1	43.1	49.6	48.3	46.4	44.7	44.2	50.2	48.9	46.9	45.3	45.1
	BF	0.00	0.05	0.03	0.01	0.05	0.12	0.05	0.03	0.02	0.16	0.08	0.05	0.04	0.04	0.25	0.07	0.05	0.04	0.06	0.33
85	TC	838	797	729	678	623	876	834	772	715	673	903	861	798	734	714	926	882	817	753	746
	SHC	345	396	475	556	621	370	430	530	628	673	392	463	581	692	714	413	494	630	742	746
	kW	52.1	50.9	49.1	47.7	46.4	53.2	51.9	50.1	48.7	47.7	53.9	52.7	50.9	49.2	48.7	54.5	53.3	51.4	49.7	49.6
	BF	0.00	0.06	0.02	0.02	0.05	0.10	0.05	0.03	0.03	0.17	0.07	0.05	0.03	0.04	0.27	0.07	0.05	0.04	0.08	0.35
95	TC	814	777	711	662	611	853	813	753	693	660	879	841	777	718	699	902	860	795	734	730
	SHC	337	388	467	548	608	362	422	522	618	660	384	455	572	683	699	405	486	621	730	730
	kW	57.3	56.2	54.4	53.2	51.9	58.4	57.3	55.6	54.1	53.1	59.3	58.1	56.3	54.8	54.2	60.0	58.7	56.9	55.2	55.1
	BF	0.00	0.05	0.02	0.02	0.07	0.08	0.05	0.03	0.02	0.19	0.06	0.05	0.03	0.04	0.29	0.07	0.05	0.04	0.09	0.36
105	TC	791	755	691	640	593	828	788	728	667	642	852	813	750	691	680	871	831	766	711	709
	SHC	330	379	458	537	593	354	413	512	607	642	375	445	561	668	680	395	476	610	702	709
	kW	63.6	62.6	60.7	59.9	58.6	64.9	63.7	62.1	60.4	59.8	65.8	64.7	63.0	61.3	60.8	66.6	65.4	63.5	61.6	61.6
	BF	0.00	0.05	0.02	0.02	0.09	0.07	0.04	0.03	0.02	0.21	0.06	0.04	0.03	0.05	0.31	0.06	0.05	0.04	0.13	0.38
115	TC	761	725	664	611	571	794	758	697	639	618	817	779	717	659	654	834	795	731	682	682
	SHC	319	367	446	523	571	341	401	498	591	618	363	433	548	646	654	382	463	595	682	682
	kW	71.2	70.3	68.2	69.1	67.5	72.7	71.9	70.5	69.9	68.5	73.9	73.0	71.5	69.6	69.2	75.0	73.8	72.0	69.2	70.0
	BF	0.12	0.04	0.02	0.02	0.13	0.06	0.04	0.03	0.03	0.24	0.06	0.04	0.03	0.07	0.33	0.06	0.05	0.04	0.14	0.40

48/50P2,P3,P4,P5070 (70 TON) HIGH-CAPACITY COIL — STANDARD MODE (cont)

Temp (F) Air Entering Condenser (Edb)		Evaporator Air Quantity — Cfm									
		28,000					30,000				
		Evaporator Air — Ewb (F)									
		75	72	67	62	57	75	72	67	62	57
75	TC	973	926	853	795	792	980	934	860	809	806
	SHC	442	534	685	787	792	453	551	711	802	806
	kW	50.6	49.3	47.4	45.9	45.9	50.8	49.5	47.5	46.3	46.2
	BF	0.07	0.06	0.05	0.14	0.39	0.07	0.06	0.05	0.18	0.42
85	TC	942	898	830	773	772	950	905	839	783	785
	SHC	432	524	676	769	772	443	541	701	783	785
	kW	55.0	53.7	51.8	50.4	50.3	55.2	54.0	52.0	50.7	50.7
	BF	0.07	0.05	0.05	0.16	0.41	0.07	0.06	0.05	0.20	0.44
95	TC	918	874	808	753	756	924	881	815	766	768
	SHC	424	516	667	753	756	435	532	692	766	768
	kW	60.5	59.2	57.3	55.7	55.8	60.7	59.5	57.6	56.1	56.2
	BF	0.07	0.05	0.05	0.17	0.42	0.07	0.06	0.05	0.21	0.45
105	TC	885	843	779	732	734	891	850	784	746	746
	SHC	414	505	654	732	734	424	522	679	746	746
	kW	67.1	65.9	64.0	62.2	62.4	67.4	66.1	64.2	62.8	62.8
	BF	0.07	0.05	0.05	0.20	0.44	0.07	0.06	0.06	0.23	0.47
115	TC	847	806	742	706	706	853	812	747	718	717
	SHC	401	492	640	706	706	412	509	664	718	717
	kW	75.8	74.5	72.8	70.6	70.7	76.1	74.9	72.9	71.0	71.0
	BF	0.06	0.05	0.05	0.22	0.46	0.07	0.05	0.06	0.26	0.49

LEGEND

48/50P3,P5 units only.

BF — Bypass Factor **kW** — Compressor Motor Power Input
Edb — Entering Dry Bulb **SHC** — Sensible Heat Cap. (1000 Btuh)
Ewb — Entering Wet Bulb **TC** — Total Cap. (1000 Btuh) Gross

NOTES:

- Direct interpolation is permissible. Do not extrapolate.
- The following formulas may be used:

$$t_{db} = t_{edb} - \frac{\text{sensible capacity (Btuh)}}{1.10 \times \text{cfm}}$$

t_{lwb} = Wet-bulb temperature corresponding to enthalpy of air leaving evaporator coil (h_{lwb}).

$$h_{lwb} = h_{ewb} - \frac{\text{total capacity (Btuh)}}{4.5 \times \text{cfm}}$$

Where: h_{ewb} = Enthalpy of air entering evaporator coil.

- SHC is based on 80 F edb temperature of air entering evaporator coil. Below 80 F edb, subtract (corr factor x cfm) from SHC. Above 80 F edb, add (corr factor x cfm) to SHC.

		ENTERING AIR DRY-BULB TEMP (F)					
		79	78	77	76	75	under 75
BF	81	82	83	84	85	over 85	
	Correction Factor						
.05	1.04	2.09	3.14	4.18	5.22	Use formula shown below	
.10	0.99	1.98	2.97	3.96	4.95		
.20	0.88	1.76	2.64	3.52	4.40		

Interpolation is permissible.
 Correction Factor = $1.10 \times (1 - \text{BF}) \times (\text{edb} - 80)$.

- Cooling capacities are gross and do not include deduction for indoor fan motor heat.

COOLING CAPACITIES (cont)

48/50P2,P3,P4,P5070 (70 TON) HIGH-CAPACITY COIL — SUBCOOL MODE

Temp (F) Air Entering Condenser (Edb)		Evaporator Air Quantity — Cfm																			
		14,000					17,500					21,000					24,500				
		Evaporator Air — Ewb (F)																			
		75	72	67	62	57	75	72	67	62	57	75	72	67	62	57	75	72	67	62	57
75	TC	798	759	699	643	604	835	793	732	675	635	861	817	754	698	669	879	836	769	716	700
	SHC	236	292	386	478	578	253	320	433	544	631	271	348	478	607	669	288	375	522	664	700
	kW	52.9	51.8	50.3	49.0	48.1	53.9	52.8	51.1	49.7	48.8	54.7	53.5	51.8	50.3	49.6	55.3	54.1	52.2	50.8	50.3
	BF	0.03	0.02	0.02	0.02	0.03	0.06	0.04	0.03	0.04	0.11	0.07	0.05	0.05	0.05	0.21	0.08	0.06	0.06	0.08	0.29
85	TC	762	725	668	610	586	795	757	697	644	600	817	778	718	664	638	833	793	733	683	667
	SHC	207	264	361	451	558	222	290	405	519	598	237	316	449	579	638	253	342	493	636	667
	kW	57.0	56.0	54.6	53.3	52.7	58.0	57.0	55.3	54.0	53.1	58.7	57.6	55.9	54.5	53.9	59.3	58.1	56.4	55.0	54.6
	BF	0.03	0.02	0.02	0.02	0.06	0.06	0.04	0.03	0.04	0.12	0.07	0.05	0.05	0.05	0.22	0.08	0.06	0.06	0.08	0.30
95	TC	723	687	632	578	560	752	716	661	610	568	773	735	679	631	607	787	749	693	649	634
	SHC	176	235	333	427	534	189	259	377	492	562	203	284	419	553	607	218	308	462	600	634
	kW	62.0	61.0	59.6	58.4	58.2	62.8	61.8	60.3	59.1	58.1	63.5	62.4	60.9	59.6	59.0	64.0	62.9	61.3	60.0	59.7
	BF	0.03	0.02	0.02	0.02	0.07	0.06	0.04	0.03	0.04	0.12	0.07	0.05	0.05	0.06	0.23	0.08	0.06	0.06	0.10	0.31
105	TC	680	646	594	548	533	706	671	618	570	528	724	688	636	592	569	737	701	648	610	598
	SHC	145	205	305	405	508	155	226	346	463	528	167	249	387	523	569	181	273	429	563	598
	kW	67.7	66.7	65.6	65.2	65.1	68.5	67.5	66.1	65.3	64.7	69.1	68.0	66.5	65.6	65.2	69.5	68.4	66.9	65.8	65.7
	BF	0.02	0.02	0.02	0.02	0.09	0.06	0.04	0.03	0.04	0.15	0.07	0.05	0.05	0.06	0.25	0.08	0.06	0.06	0.12	0.33
115	TC	633	601	553	504	502	656	624	575	532	507	671	638	590	559	536	683	649	601	572	556
	SHC	111	173	276	373	479	120	193	316	442	507	130	214	355	494	536	143	236	396	527	556
	kW	74.5	73.8	73.2	73.1	73.5	75.1	74.2	73.4	73.0	72.9	75.5	74.6	73.6	73.1	72.9	75.9	74.9	73.7	73.1	73.0
	BF	0.02	0.02	0.02	0.02	0.10	0.06	0.04	0.03	0.04	0.17	0.07	0.05	0.05	0.08	0.27	0.08	0.06	0.06	0.13	0.34

48/50P2,P3,P4,P5070 (70 TON) HIGH-CAPACITY COIL — SUBCOOL MODE (cont)

Temp (F) Air Entering Condenser (Edb)		Evaporator Air Quantity — Cfm									
		28,000					30,000				
		Evaporator Air — Ewb (F)									
		75	72	67	62	57	75	72	67	62	57
75	TC	894	849	783	733	723	901	851	788	741	736
	SHC	305	403	567	705	723	314	414	590	728	736
	kW	55.7	54.5	52.7	51.2	51.0	56.0	54.4	52.8	51.5	51.3
	BF	0.09	0.08	0.07	0.12	0.36	0.10	0.08	0.08	0.15	0.40
85	TC	845	805	745	701	692	852	810	750	709	703
	SHC	269	368	536	675	692	278	383	560	696	703
	kW	59.7	58.5	56.8	55.5	55.3	59.9	58.7	56.9	55.7	55.6
	BF	0.09	0.08	0.07	0.13	0.37	0.10	0.08	0.08	0.16	0.40
95	TC	798	760	703	666	659	804	765	708	673	664
	SHC	233	334	503	641	659	241	348	527	662	664
	kW	64.4	63.3	61.6	60.5	60.3	64.6	63.4	61.8	60.7	60.5
	BF	0.09	0.08	0.07	0.15	0.38	0.10	0.08	0.08	0.17	0.41
105	TC	747	710	657	626	619	752	715	661	633	628
	SHC	195	297	470	603	619	203	311	492	624	628
	kW	69.9	68.8	67.2	66.3	66.1	70.0	68.9	67.4	66.5	66.4
	BF	0.09	0.08	0.07	0.16	0.39	0.10	0.08	0.08	0.18	0.42
115	TC	691	657	609	583	573	696	660	613	589	582
	SHC	156	260	436	563	573	164	273	458	583	582
	kW	76.2	75.2	73.9	73.3	73.2	76.4	75.3	74.0	73.4	73.3
	BF	0.09	0.08	0.07	0.18	0.41	0.10	0.08	0.08	0.20	0.44

LEGEND

48/50P3,P5 units only.

BF — Bypass Factor **kW** — Compressor Motor Power Input
Edb — Entering Dry Bulb **SHC** — Sensible Heat Cap. (1000 Btuh)
Ewb — Entering Wet Bulb **TC** — Total Cap. (1000 Btuh) Gross

NOTES:

- The SHC is based on 80 F edb temperature of air entering evaporator coil. For edb temperatures other than 80 F, adjust SHC by multiplying the correction factor and the cfm and then adding or subtracting the value from the SHC.

- Interpolation is permissible.
- Correction Factor = $1.10 \times (1 - BF) \times (edb - 80)$.
- Cooling capacities are gross and do not include deduction for indoor fan motor heat.
- SHC values provided are in subcooling mode with the gas bypass valve closed and reflect the maximum SHC in subcooling mode. The P Series innovative modulating valve system can reduce SHC as needed to meet the supply air set point requirement with minimal change in latent capacity. This will provide variable SHC to meet the space load.

Performance data (cont)



COOLING CAPACITIES (cont)

48/50P2,P3,P4,P5070 (70 TON) HIGH-CAPACITY COIL — HOT GAS REHEAT MODE

Temp (F) Air Ent Condenser (Edb)		Air Entering Evaporator — Ewb (F)											
		75 Dry Bulb 62.5 Wet Bulb (50% RH)					75 Dry Bulb 65.3 Wet Bulb (60% RH)						
		Air Entering Evaporator — Cfm											
		14,000	17,500	21,000	24,500	28,000	30,000	14,000	17,500	21,000	24,500	28,000	30,000
80	TC	286	304	315	323	329	331	303	320	331	339	345	347
	SHC	34	66	98	132	166	186	-30	-10	12	35	61	75
	kW	51.9	51.4	51.6	51.8	51.9	52.0	52.4	52.5	52.7	52.9	53.0	53.1
	BF	0.02	0.03	0.05	0.06	0.07	0.08	0.02	0.04	0.05	0.06	0.07	0.08
75	TC	293	310	321	329	334	337	307	325	336	344	350	353
	SHC	39	70	102	136	170	190	-28	-7	15	39	64	78
	kW	49.7	49.8	50.1	50.4	50.5	50.6	51.5	51.2	51.4	51.6	51.8	51.9
	BF	0.02	0.03	0.05	0.06	0.07	0.08	0.02	0.04	0.05	0.06	0.07	0.08
70	TC	297	314	325	333	339	342	312	330	341	349	355	357
	SHC	42	72	105	139	173	192	-24	-5	17	41	67	81
	kW	48.5	48.7	49.0	49.2	49.4	49.5	49.7	50.0	50.3	50.5	50.7	50.8
	BF	0.02	0.03	0.05	0.06	0.07	0.08	0.02	0.04	0.05	0.06	0.07	0.08
60	TC	293	308	318	324	330	332	306	322	332	339	344	346
	SHC	42	71	104	137	171	191	-24	-6	16	40	65	80
	kW	50.5	51.0	51.5	51.8	52.1	52.2	52.0	52.6	53.0	53.3	53.6	53.8
	BF	0.02	0.03	0.05	0.06	0.08	0.08	0.02	0.04	0.05	0.06	0.08	0.08
50	TC	301	316	326	333	339	342	315	330	341	348	354	356
	SHC	47	76	109	143	174	193	-19	0	22	42	67	81
	kW	48.0	48.6	49.1	49.5	49.8	49.9	49.5	50.1	50.6	51.0	51.3	51.4
	BF	0.02	0.03	0.05	0.06	0.08	0.09	0.02	0.04	0.05	0.07	0.08	0.09
40	TC	306	322	333	341	347	350	321	337	348	357	364	367
	SHC	51	81	114	145	179	198	-14	5	24	47	73	87
	kW	45.9	46.6	47.2	47.5	47.8	47.9	47.5	48.2	48.6	49.0	49.3	49.4
	BF	0.02	0.03	0.05	0.06	0.08	0.09	0.02	0.04	0.05	0.07	0.08	0.09

48/50P2,P3,P4,P5070 (70 TON) HIGH-CAPACITY COIL — HOT GAS REHEAT MODE (cont)

Temp (F) Air Ent Condenser (Edb)		Air Entering Evaporator — Ewb (F)											
		75 Dry Bulb 68 Wet Bulb (70% RH)					75 Dry Bulb 70.5 Wet Bulb (80% RH)						
		Air Entering Evaporator — Cfm											
		14,000	17,500	21,000	24,500	28,000	30,000	14,000	17,500	21,000	24,500	28,000	30,000
80	TC	316	335	347	355	361	364	332	350	362	370	377	380
	SHC	-96	-86	-73	-59	-44	-34	-154	-155	-153	-148	-141	-136
	kW	54.4	53.8	54.0	54.2	54.4	54.4	55.0	55.1	55.4	55.5	55.7	55.7
	BF	0.02	0.04	0.05	0.07	0.08	0.09	0.00	0.06	0.07	0.09	0.10	0.11
75	TC	323	341	352	360	366	369	336	355	367	376	382	385
	SHC	-91	-82	-71	-57	-41	-31	-154	-153	-150	-145	-138	-133
	kW	52.3	52.5	52.8	53.0	53.1	53.2	54.4	53.9	54.1	54.3	54.5	54.5
	BF	0.02	0.04	0.05	0.07	0.08	0.09	0.00	0.06	0.07	0.09	0.10	0.11
70	TC	326	345	357	365	372	375	342	360	372	382	390	393
	SHC	-90	-80	-68	-54	-37	-28	-148	-150	-147	-142	-134	-130
	kW	51.5	51.4	51.7	51.9	52.1	52.2	52.4	52.8	53.0	53.3	53.4	53.5
	BF	0.02	0.04	0.05	0.07	0.08	0.09	0.00	0.06	0.07	0.09	0.10	0.11
60	TC	320	336	346	353	359	361	333	349	360	368	373	376
	SHC	-89	-81	-69	-55	-39	-34	-149	-151	-148	-143	-136	-132
	kW	53.6	54.1	54.6	54.9	55.2	55.5	55.2	55.7	56.1	56.5	56.7	56.8
	BF	0.02	0.04	0.05	0.07	0.08	0.10	0.00	0.06	0.07	0.09	0.10	0.11
50	TC	329	345	356	363	369	371	342	359	369	378	383	386
	SHC	-83	-75	-62	-53	-38	-29	-143	-145	-147	-136	-135	-131
	kW	51.1	51.7	52.2	52.6	52.8	52.9	52.7	53.3	53.9	54.1	54.5	54.6
	BF	0.02	0.04	0.05	0.08	0.09	0.10	0.00	0.06	0.08	0.09	0.11	0.12
40	TC	335	352	365	374	381	385	349	368	383	390	398	401
	SHC	-78	-74	-62	-40	-32	-23	-138	-138	-150	-129	-129	-124
	kW	49.1	49.7	50.2	50.7	50.8	51.0	50.7	51.3	50.8	52.2	52.4	52.5
	BF	0.02	0.04	0.06	0.07	0.09	0.10	0.00	0.06	0.08	0.09	0.11	0.12

LEGEND

BF — Bypass Factor
Edb — Entering Dry Bulb
Ewb — Entering Wet Bulb
kW — Compressor Motor Power Input
RH — Relative Humidity
SHC — Sensible Heat Cap. (1000 Btu/h)
TC — Total Cap. (1000 Btu/h) Gross

6. SHC values provided reflect maximum reheat values with 100% gas bypass. Negative SHC value indicates that the air entering the coil is being heated at 100% gas bypass. The P Series innovative modulating valve system will reduce the gas bypass as required to meet the supply air setpoint with minimal change in latent capacity. The space will NOT be overheated and the unit will provide variable SHC to meet the space load.

NOTES:

- The SHC is based on 75 F edb temperature of air entering evaporator coil. For edb temperatures other than 75 F, adjust SHC by multiplying the correction factor and the cfm and then adding or subtracting the value from the SHC.
- Interpolation is permissible.
- Correction Factor = $1.10 \times (1 - BF) \times (edb - 75)$.
- Cooling capacities are gross and do not include deduction for indoor fan motor heat.
- Capacity table includes impact of outdoor fan staging at temperatures below 75 F.

COOLING CAPACITIES (cont)

48/50P2,P3,P4,P5075 (75 TON) STANDARD CAPACITY COIL — STANDARD MODE

Temp (F) Air Entering Condenser (Edb)		Evaporator Air Quantity — Cfm																			
		14,000					17,500					21,000					24,500				
		Evaporator Air — Ewb (F)																			
		75	72	67	62	57	75	72	67	62	57	75	72	67	62	57	75	72	67	62	57
75	TC	889	852	787	724	663	933	893	826	763	705	960	917	854	789	745	981	937	874	809	780
	SHC	365	410	491	568	635	377	443	540	634	695	402	472	585	693	745	420	499	627	747	780
	kW	50.7	49.6	48.1	46.7	45.8	51.8	50.7	49.0	47.7	46.5	52.6	51.4	49.7	48.3	47.3	53.3	52.0	50.3	48.8	48.0
	BF	0.00	0.00	0.10	0.07	0.08	0.00	0.16	0.10	0.09	0.16	0.30	0.14	0.11	0.10	0.24	0.20	0.14	0.12	0.12	0.32
85	TC	869	831	766	703	641	909	870	803	740	686	935	892	829	765	726	957	910	848	783	760
	SHC	357	402	482	558	619	372	435	530	623	679	394	463	575	682	726	413	490	617	734	760
	kW	55.8	54.9	53.4	52.1	51.2	57.0	55.9	54.4	53.1	52.0	57.7	56.5	55.1	53.8	52.9	58.4	57.1	55.6	54.2	53.5
	BF	0.00	0.00	0.10	0.07	0.09	0.00	0.15	0.10	0.08	0.18	0.24	0.13	0.11	0.10	0.26	0.18	0.13	0.12	0.13	0.33
95	TC	844	803	740	679	615	880	841	775	711	662	906	864	799	735	704	925	884	817	752	735
	SHC	346	392	470	547	602	364	424	518	609	662	384	453	563	667	704	403	480	605	716	735
	kW	62.0	60.8	59.8	58.3	58.6	63.0	62.1	60.7	59.5	58.9	63.9	62.7	61.4	60.2	59.1	64.6	63.5	61.9	60.5	60.1
	BF	0.00	0.19	0.09	0.06	0.10	0.00	0.14	0.10	0.08	0.19	0.20	0.12	0.11	0.10	0.28	0.17	0.13	0.12	0.13	0.36
105	TC	813	773	709	649	592	846	806	742	679	637	869	828	765	701	678	886	846	781	717	708
	SHC	331	380	457	532	582	353	412	504	593	637	372	440	549	650	678	390	467	591	693	708
	kW	69.2	68.3	67.4	67.1	67.2	70.3	69.1	68.6	68.7	68.2	71.1	69.7	69.1	69.2	68.0	71.8	70.7	69.6	69.1	68.7
	BF	0.00	0.16	0.08	0.06	0.13	0.00	0.12	0.09	0.08	0.22	0.17	0.11	0.10	0.11	0.31	0.16	0.13	0.12	0.15	0.38
115	TC	779	739	676	616	562	808	770	706	643	610	830	791	726	664	647	845	806	742	683	677
	SHC	316	367	443	516	560	340	398	489	576	610	360	427	533	631	647	377	452	574	669	677
	kW	78.2	78.6	77.5	78.0	79.9	79.3	78.4	78.9	79.8	79.5	80.3	79.9	79.3	79.9	79.4	81.0	80.3	79.6	78.5	79.4
	BF	0.00	0.14	0.08	0.06	0.14	0.20	0.11	0.09	0.08	0.25	0.15	0.11	0.10	0.11	0.34	0.15	0.13	0.12	0.17	0.41

48/50P2,P3,P4,P5075 (75 TON) STANDARD CAPACITY COIL — STANDARD MODE (cont)

Temp (F) Air Entering Condenser (Edb)		Evaporator Air Quantity — Cfm									
		28,000					30,000				
		Evaporator Air — Ewb (F)									
		75	72	67	62	57	75	72	67	62	57
75	TC	1000	955	889	823	808	1007	964	896	830	822
	SHC	439	525	668	791	808	448	539	690	811	822
	kW	53.7	52.5	50.7	49.1	48.7	53.9	52.7	50.9	49.3	49.1
	BF	0.18	0.15	0.13	0.16	0.38	0.18	0.15	0.14	0.18	0.41
85	TC	972	930	862	798	787	979	937	869	804	801
	SHC	430	516	658	773	787	439	530	680	797	801
	kW	58.9	57.7	56.0	54.5	54.2	59.1	57.9	56.2	54.6	54.5
	BF	0.17	0.14	0.13	0.17	0.40	0.17	0.15	0.14	0.19	0.43
95	TC	939	898	831	766	762	946	904	837	777	775
	SHC	420	505	645	757	762	429	519	667	771	775
	kW	65.0	64.0	62.3	60.8	60.6	65.2	64.2	62.4	61.0	61.0
	BF	0.16	0.14	0.13	0.17	0.42	0.16	0.15	0.14	0.21	0.44
105	TC	899	859	793	736	733	905	864	800	748	746
	SHC	407	491	631	725	733	416	505	653	739	746
	kW	72.2	71.2	69.9	68.9	69.0	72.4	71.4	70.2	69.0	69.2
	BF	0.16	0.14	0.13	0.21	0.44	0.16	0.15	0.13	0.25	0.47
115	TC	857	818	753	705	701	863	823	759	717	713
	SHC	393	477	615	692	701	403	491	637	702	713
	kW	81.3	80.8	80.2	79.2	79.5	81.6	81.0	80.2	79.3	79.5
	BF	0.15	0.14	0.13	0.25	0.46	0.15	0.14	0.13	0.29	0.49

LEGEND

48/50P3,P5 units only.

BF — Bypass Factor **kW** — Compressor Motor Power Input
Edb — Entering Dry Bulb **SHC** — Sensible Heat Cap. (1000 Btuh)
Ewb — Entering Wet Bulb **TC** — Total Cap. (1000 Btuh) Gross

NOTES:

- Direct interpolation is permissible. Do not extrapolate.
- The following formulas may be used:

$$t_{db} = t_{edb} - \frac{\text{sensible capacity (Btuh)}}{1.10 \times \text{cfm}}$$

t_{lwb} = Wet-bulb temperature corresponding to enthalpy of air leaving evaporator coil (h_{lwb}).

$$h_{lwb} = h_{ewb} - \frac{\text{total capacity (Btuh)}}{4.5 \times \text{cfm}}$$

Where: h_{ewb} = Enthalpy of air entering evaporator coil.

- SHC is based on 80 F edb temperature of air entering evaporator coil.
Below 80 F edb, subtract (corr factor x cfm) from SHC.
Above 80 F edb, add (corr factor x cfm) to SHC.

BF	ENTERING AIR DRY-BULB TEMP (F)					
	79	78	77	76	75	under 75
	81	82	83	84	85	over 85
Correction Factor						
.05	1.04	2.09	3.14	4.18	5.22	Use formula shown below
.10	0.99	1.98	2.97	3.96	4.95	
.20	0.88	1.76	2.64	3.52	4.40	

Interpolation is permissible.
Correction Factor = $1.10 \times (1 - BF) \times (edb - 80)$.

- Cooling capacities are gross and do not include deduction for indoor fan motor heat.

Performance data (cont)



COOLING CAPACITIES (cont)

48/50P2,P3,P4,P5075 (75 TON) STANDARD CAPACITY COIL — SUBCOOL MODE

Temp (F) Air Entering Condenser (Edb)		Evaporator Air Quantity — Cfm																			
		14,000					17,500					21,000					24,500				
		Evaporator Air — Ewb (F)																			
		75	72	67	62	57	75	72	67	62	57	75	72	67	62	57	75	72	67	62	57
75	TC	847	771	745	681	619	871	829	760	720	659	900	856	789	725	674	914	868	809	743	709
	SHC	281	299	432	507	582	284	347	447	572	649	301	373	494	610	674	310	391	530	665	709
	kW	56.6	54.6	54.8	53.8	53.0	57.3	56.2	54.5	54.5	53.9	58.2	57.0	55.2	53.7	52.5	58.7	57.4	55.8	54.1	53.3
	BF	0.00	0.07	0.07	0.06	0.07	0.06	0.10	0.09	0.09	0.14	0.14	0.12	0.11	0.11	0.22	0.16	0.14	0.12	0.13	0.31
85	TC	803	756	715	653	593	832	817	713	668	632	860	819	755	681	670	878	838	773	710	680
	SHC	246	293	403	486	562	254	344	410	527	623	272	346	468	576	670	287	371	508	639	680
	kW	61.1	59.9	59.9	59.1	58.1	61.9	62.1	58.9	57.8	58.4	62.8	61.7	59.9	58.3	59.6	63.4	62.2	60.4	58.8	58.1
	BF	0.00	0.07	0.07	0.06	0.08	0.16	0.10	0.09	0.09	0.15	0.14	0.12	0.11	0.11	0.24	0.16	0.14	0.13	0.13	0.32
95	TC	759	720	681	623	566	794	755	694	603	606	818	779	717	682	641	859	797	734	674	648
	SHC	212	266	378	464	540	227	292	399	471	599	242	317	441	585	641	282	341	480	611	648
	kW	66.4	65.4	65.6	64.8	64.5	67.4	66.4	64.7	62.6	64.9	68.2	67.1	65.4	66.0	65.6	69.9	67.6	65.9	64.3	63.7
	BF	0.00	0.07	0.07	0.06	0.09	0.14	0.10	0.09	0.09	0.16	0.14	0.12	0.11	0.11	0.25	0.16	0.14	0.13	0.14	0.33
105	TC	718	681	647	590	533	751	714	654	621	576	773	736	677	645	610	789	752	692	634	613
	SHC	183	238	354	440	508	198	263	371	501	576	212	287	412	559	610	226	311	451	582	613
	kW	72.6	71.6	72.3	71.5	71.1	73.6	72.6	71.0	71.9	72.1	74.3	73.2	71.6	72.6	72.3	74.9	73.7	72.1	70.5	70.0
	BF	0.06	0.07	0.07	0.06	0.11	0.14	0.10	0.09	0.09	0.17	0.14	0.12	0.11	0.11	0.27	0.15	0.13	0.13	0.14	0.34
115	TC	674	639	611	555	510	704	669	613	581	554	724	689	633	607	576	764	704	647	622	577
	SHC	154	209	330	415	486	167	233	342	472	540	180	256	382	533	576	219	279	421	570	577
	kW	79.6	78.7	80.2	79.6	80.4	80.5	79.5	78.1	79.8	79.7	81.2	80.1	78.6	80.3	80.2	83.1	80.6	79.0	80.7	77.3
	BF	0.05	0.07	0.07	0.07	0.13	0.13	0.10	0.09	0.09	0.18	0.14	0.12	0.11	0.12	0.29	0.15	0.13	0.13	0.17	0.36

48/50P2,P3,P4,P5075 (75 TON) STANDARD CAPACITY COIL — SUBCOOL MODE (cont)

Temp (F) Air Entering Condenser (Edb)		Evaporator Air Quantity — Cfm									
		28,000					30,000				
		Evaporator Air — Ewb (F)									
		75	72	67	62	57	75	72	67	62	57
75	TC	939	893	823	780	736	947	900	830	764	773
	SHC	329	424	575	736	736	338	437	596	741	773
	kW	59.3	58.1	56.2	55.8	54.0	59.6	58.3	56.4	54.7	55.8
	BF	0.17	0.15	0.14	0.16	0.37	0.18	0.16	0.15	0.17	0.40
85	TC	893	852	787	724	706	900	884	817	731	719
	SHC	302	394	547	685	706	310	433	593	703	719
	kW	63.9	62.7	60.9	59.2	58.8	64.1	64.0	62.2	59.4	59.1
	BF	0.17	0.15	0.14	0.16	0.38	0.18	0.16	0.15	0.19	0.41
95	TC	849	810	747	687	673	854	817	753	696	685
	SHC	271	365	519	649	673	283	373	540	670	685
	kW	69.2	68.0	66.3	64.6	64.3	69.4	68.3	66.5	64.9	64.6
	BF	0.17	0.15	0.14	0.18	0.39	0.18	0.16	0.15	0.21	0.42
105	TC	802	764	705	650	637	830	770	710	658	649
	SHC	235	334	489	614	637	280	346	510	634	649
	kW	75.3	74.1	72.4	70.9	70.6	76.7	74.3	72.6	71.1	70.9
	BF	0.17	0.15	0.14	0.20	0.41	0.18	0.16	0.15	0.22	0.44
115	TC	750	715	658	635	599	787	720	663	617	609
	SHC	206	301	458	605	599	236	314	479	596	609
	kW	82.1	81.0	79.3	80.9	77.8	83.9	81.2	79.5	78.2	78.0
	BF	0.17	0.15	0.14	0.21	0.42	0.18	0.16	0.15	0.24	0.45

LEGEND

48/50P3,P5 units only.

BF — Bypass Factor **kW** — Compressor Motor Power Input
Edb — Entering Dry Bulb **SHC** — Sensible Heat Cap. (1000 Btuh)
Ewb — Entering Wet Bulb **TC** — Total Cap. (1000 Btuh) Gross

NOTES:

1. The SHC is based on 80 F edb temperature of air entering evaporator coil. For edb temperatures other than 80 F, adjust SHC by multiplying the correction factor and the cfm and then adding or subtracting the value from the SHC.

- Interpolation is permissible.
- Correction Factor = $1.10 \times (1 - BF) \times (edb - 80)$.
- Cooling capacities are gross and do not include deduction for indoor fan motor heat.
- SHC values provided are in subcooling mode with the gas bypass valve closed and reflect the maximum SHC in subcooling mode. The P Series innovative modulating valve system can reduce SHC as needed to meet the supply air set point requirement with minimal change in latent capacity. This will provide variable SHC to meet the space load.

COOLING CAPACITIES (cont)

48/50P2,P3,P4,P5075 (75 TON) STANDARD CAPACITY COIL — HOT GAS REHEAT MODE

Temp (F) Air Ent Condenser (Edb)		Air Entering Evaporator — Ewb (F)											
		75 Dry Bulb 62.5 Wet Bulb (50% RH)					75 Dry Bulb 65.3 Wet Bulb (60% RH)						
		Air Entering Evaporator — Cfm											
		14,000	17,500	21,000	24,500	28,000	30,000	14,000	17,500	21,000	24,500	28,000	30,000
80	TC	268	288	302	311	319	322	285	305	319	329	336	339
	SHC	11	39	67	97	127	144	-52	-35	-16	5	26	38
	kW	58.8	58.5	58.3	58.2	58.2	58.2	59.6	59.2	59.0	58.9	59.0	59.0
	BF	0.07	0.09	0.11	0.13	0.15	0.16	0.07	0.09	0.11	0.13	0.15	0.16
75	TC	275	296	309	319	327	330	292	313	327	336	344	347
	SHC	15	43	71	101	131	148	-48	-31	-12	9	30	42
	kW	56.8	56.5	56.4	56.3	56.3	56.4	57.7	57.3	57.2	57.2	57.2	57.2
	BF	0.07	0.09	0.11	0.13	0.15	0.15	0.07	0.09	0.11	0.13	0.15	0.16
70	TC	282	302	316	326	334	337	299	319	334	344	351	355
	SHC	19	47	75	105	135	152	-44	-27	-8	12	33	46
	kW	55.0	54.7	54.6	54.6	54.7	54.7	55.9	55.6	55.5	55.5	55.5	55.5
	BF	0.07	0.09	0.11	0.13	0.15	0.15	0.07	0.09	0.11	0.13	0.15	0.16
60	TC	279	297	309	317	323	326	294	312	324	332	338	341
	SHC	19	46	74	103	132	149	-45	-29	-11	9	30	42
	kW	56.5	56.5	56.5	56.7	56.8	56.9	57.6	57.6	57.8	57.9	58.1	58.2
	BF	0.07	0.09	0.11	0.13	0.15	0.16	0.07	0.09	0.11	0.13	0.15	0.16
50	TC	290	309	322	330	337	340	305	324	337	346	352	355
	SHC	26	53	81	110	139	156	-38	-22	-3	16	37	49
	kW	53.0	53.1	53.3	53.5	53.7	53.8	54.2	54.3	54.5	54.8	55.0	55.1
	BF	0.07	0.09	0.11	0.13	0.15	0.15	0.07	0.09	0.11	0.13	0.15	0.16
40	TC	300	319	332	341	348	351	315	335	348	357	364	367
	SHC	32	59	87	116	145	162	-32	-16	3	23	44	56
	kW	50.1	50.3	50.6	50.9	51.1	51.2	51.4	51.6	51.9	52.2	52.5	52.6
	BF	0.07	0.09	0.11	0.13	0.15	0.15	0.07	0.09	0.11	0.13	0.15	0.16

48/50P2,P3,P4,P5075 (75 TON) STANDARD CAPACITY COIL — HOT GAS REHEAT MODE (cont)

Temp (F) Air Ent Condenser (Edb)		Air Entering Evaporator — Ewb (F)											
		75 Dry Bulb 68 Wet Bulb (70% RH)					75 Dry Bulb 70.5 Wet Bulb (80% RH)						
		Air Entering Evaporator — Cfm											
		14,000	17,500	21,000	24,500	28,000	30,000	14,000	17,500	21,000	24,500	28,000	30,000
80	TC	301	322	336	345	353	356	317	337	351	361	369	372
	SHC	-114	-107	-97	-86	-73	-65	-173	-175	-174	-170	-164	-160
	kW	60.5	60.1	59.9	59.9	59.9	59.9	61.5	61.1	60.9	61.0	61.0	60.9
	BF	0.07	0.10	0.12	0.14	0.16	0.17	0.00	0.13	0.14	0.15	0.17	0.18
75	TC	308	329	343	353	361	364	324	345	359	369	377	380
	SHC	-110	-103	-94	-82	-69	-61	-169	-171	-170	-166	-161	-157
	kW	58.6	58.3	58.1	58.1	58.2	58.2	59.6	59.3	59.2	59.2	59.3	59.3
	BF	0.07	0.10	0.12	0.14	0.16	0.17	0.00	0.13	0.14	0.15	0.17	0.18
70	TC	315	336	351	360	368	372	330	352	366	376	385	390
	SHC	-107	-100	-90	-78	-65	-58	-166	-168	-166	-162	-157	-153
	kW	56.8	56.5	56.4	56.6	56.6	56.7	58.0	57.7	57.6	57.7	57.7	57.8
	BF	0.07	0.10	0.12	0.14	0.16	0.17	0.00	0.06	0.14	0.15	0.17	0.18
60	TC	308	326	339	347	353	356	321	340	352	361	368	371
	SHC	-108	-102	-92	-81	-68	-61	-167	-170	-169	-165	-160	-157
	kW	58.9	59.0	59.1	59.3	59.4	59.5	60.3	60.3	60.4	60.6	60.8	60.9
	BF	0.07	0.10	0.12	0.14	0.16	0.17	0.00	0.12	0.14	0.15	0.17	0.18
50	TC	320	339	352	361	367	371	334	353	366	375	382	385
	SHC	-101	-95	-85	-74	-61	-54	-160	-162	-161	-158	-153	-150
	kW	55.6	55.7	55.9	56.2	56.4	56.5	57.0	57.1	57.4	57.6	57.7	57.8
	BF	0.07	0.10	0.12	0.14	0.16	0.17	0.00	0.14	0.14	0.15	0.17	0.18
40	TC	330	350	363	372	380	384	344	364	377	388	397	401
	SHC	-95	-88	-79	-68	-55	-48	-154	-156	-155	-152	-146	-143
	kW	52.8	53.1	53.4	53.7	54.0	54.1	54.3	54.5	54.9	55.2	55.4	55.6
	BF	0.07	0.10	0.12	0.14	0.16	0.17	0.00	0.06	0.14	0.16	0.17	0.18

LEGEND

BF — Bypass Factor **RH** — Relative Humidity
Edb — Entering Dry Bulb **SHC** — Sensible Heat Cap. (1000 Btu/h)
Ewb — Entering Wet Bulb **TC** — Total Cap. (1000 Btu/h) Gross
kW — Compressor Motor Power
 Input

NOTES:

- The SHC is based on 75 F edb temperature of air entering evaporator coil. For edb temperatures other than 75 F, adjust SHC by multiplying the correction factor and the cfm and then adding or subtracting the value from the SHC.
- Interpolation is permissible.

- Correction Factor = $1.10 \times (1 - BF) \times (edb - 75)$.
- Cooling capacities are gross and do not include deduction for indoor fan motor heat.
- Capacity table includes impact of outdoor fan staging at temperatures below 75 F.
- SHC values provided reflect maximum reheat values with 100% gas bypass. Negative SHC value indicates that the air entering the coil is being heated at 100% gas bypass. The P Series innovative modulating valve system will reduce the gas bypass as required to meet the supply air setpoint with minimal change in latent capacity. The space will NOT be overheated and the unit will provide variable SHC to meet the space load.

Performance data (cont)



COOLING CAPACITIES (cont)

48/50P2,P3,P4,P5075 (75 TON) HIGH-CAPACITY COIL — STANDARD MODE

Temp (F) Air Entering Condenser (Edb)		Evaporator Air Quantity — Cfm																			
		14,000					17,500					21,000					24,500				
		Evaporator Air — Ewb (F)																			
		75	72	67	62	57	75	72	67	62	57	75	72	67	62	57	75	72	67	62	57
75	TC	912	868	796	732	674	960	913	841	773	721	992	944	871	803	767	1016	967	892	823	805
	SHC	376	425	505	584	657	400	461	560	658	721	423	493	611	724	767	444	525	659	785	805
	kW	51.6	50.4	48.4	46.7	45.3	52.9	51.5	49.5	47.8	46.5	53.8	52.4	50.3	48.5	47.7	54.4	53.0	50.9	49.1	48.7
	BF	0.00	0.09	0.02	0.02	0.02	0.00	0.06	0.03	0.02	0.12	0.10	0.05	0.04	0.04	0.22	0.07	0.05	0.04	0.05	0.30
85	TC	885	837	776	714	660	928	884	819	752	708	958	913	847	786	752	980	938	869	802	787
	SHC	363	413	495	575	649	389	449	550	649	708	411	482	601	716	752	431	514	650	774	787
	kW	56.5	55.2	53.3	51.7	50.4	57.7	56.4	54.4	52.6	51.6	58.6	57.2	55.3	53.6	52.7	59.3	57.9	55.9	54.1	53.7
	BF	0.00	0.05	0.03	0.01	0.03	0.14	0.05	0.03	0.02	0.13	0.08	0.05	0.03	0.04	0.23	0.07	0.05	0.04	0.06	0.31
95	TC	858	809	759	698	643	901	861	793	735	693	931	889	825	763	735	954	913	845	777	769
	SHC	352	402	487	567	636	379	441	540	643	693	402	474	592	705	735	423	505	641	760	769
	kW	62.2	60.8	59.3	57.7	56.5	63.5	62.3	60.3	58.8	57.7	64.5	63.2	61.3	59.7	58.8	65.3	64.0	62.0	60.0	59.8
	BF	0.00	0.04	0.03	0.02	0.04	0.11	0.05	0.03	0.01	0.15	0.07	0.05	0.03	0.04	0.25	0.07	0.05	0.04	0.06	0.33
105	TC	835	795	730	676	623	875	834	767	709	673	903	862	796	733	714	922	881	813	751	746
	SHC	344	396	476	555	614	370	430	529	626	673	392	463	580	690	714	412	493	628	744	746
	kW	69.2	68.0	66.1	65.2	63.6	70.7	69.5	67.4	66.2	65.0	71.8	70.6	68.7	67.0	66.1	72.6	71.3	69.3	67.3	67.1
	BF	0.00	0.05	0.02	0.02	0.08	0.09	0.05	0.02	0.02	0.17	0.07	0.05	0.03	0.04	0.27	0.06	0.05	0.04	0.07	0.35
115	TC	804	766	701	645	596	840	799	735	677	648	865	826	760	699	687	884	843	777	719	718
	SHC	334	384	463	540	596	358	418	515	611	648	379	450	565	673	687	399	480	614	709	718
	kW	77.7	76.8	74.5	75.6	74.1	79.5	78.3	76.4	75.8	74.9	80.7	79.8	78.3	76.7	75.8	82.1	80.8	79.0	75.3	76.5
	BF	0.00	0.05	0.02	0.02	0.09	0.07	0.04	0.02	0.02	0.21	0.06	0.04	0.03	0.04	0.30	0.06	0.05	0.04	0.12	0.37

48/50P2,P3,P4,P5075 (75 TON) HIGH-CAPACITY COIL — STANDARD MODE (cont)

Temp (F) Air Entering Condenser (Edb)		Evaporator Air Quantity — Cfm									
		28,000					30,000				
		Evaporator Air — Ewb (F)									
		75	72	67	62	57	75	72	67	62	57
75	TC	1034	985	909	839	836	1042	993	916	853	851
	SHC	463	555	707	833	836	473	571	733	849	851
	kW	54.9	53.5	51.4	49.6	49.5	55.2	53.8	51.6	50.0	49.9
	BF	0.08	0.06	0.05	0.09	0.36	0.08	0.06	0.05	0.13	0.39
85	TC	1001	955	885	817	816	1009	963	892	831	829
	SHC	452	544	698	817	816	463	561	724	820	829
	kW	59.8	58.5	56.4	54.5	54.5	60.1	58.7	56.6	55.0	54.9
	BF	0.07	0.06	0.05	0.10	0.38	0.08	0.06	0.05	0.17	0.41
95	TC	973	929	859	799	797	981	936	867	812	810
	SHC	443	535	687	796	797	453	552	713	806	810
	kW	65.9	64.6	62.5	60.6	60.6	66.2	64.8	62.8	61.0	61.0
	BF	0.07	0.06	0.05	0.13	0.39	0.07	0.06	0.05	0.18	0.42
105	TC	938	895	827	772	772	945	901	833	784	785
	SHC	431	523	674	767	772	442	539	699	784	785
	kW	73.3	71.9	69.9	67.6	67.9	73.6	72.2	70.2	68.1	68.3
	BF	0.07	0.05	0.05	0.16	0.41	0.07	0.06	0.05	0.20	0.44
115	TC	898	856	789	742	743	905	862	794	756	755
	SHC	418	510	659	742	743	429	526	684	756	755
	kW	83.0	81.6	80.0	76.5	77.3	83.4	82.0	80.0	77.6	77.7
	BF	0.07	0.05	0.05	0.18	0.43	0.07	0.06	0.05	0.22	0.46

LEGEND

48/50P3,P5 units only.

BF — Bypass Factor **kW** — Compressor Motor Power Input
Edb — Entering Dry Bulb **SHC** — Sensible Heat Cap. (1000 Btuh)
Ewb — Entering Wet Bulb **TC** — Total Cap. (1000 Btuh) Gross

NOTES:

- Direct interpolation is permissible. Do not extrapolate.
- The following formulas may be used:

$$t_{db} = t_{edb} - \frac{\text{sensible capacity (Btuh)}}{1.10 \times \text{cfm}}$$

$$t_{lwb} = \text{Wet-bulb temperature corresponding to enthalpy of air leaving evaporator coil } (h_{lwb}).$$

$$h_{lwb} = h_{ewb} - \frac{\text{total capacity (Btuh)}}{4.5 \times \text{cfm}}$$

Where: h_{ewb} = Enthalpy of air entering evaporator coil.

- SHC is based on 80 F edb temperature of air entering evaporator coil.

Below 80 F edb, subtract (corr factor x cfm) from SHC.
 Above 80 F edb, add (corr factor x cfm) to SHC.

		ENTERING AIR DRY-BULB TEMP (F)					
		79	78	77	76	75	under 75
BF		81	82	83	84	85	over 85
	Correction Factor						
	.05	1.04	2.09	3.14	4.18	5.22	Use formula shown below
	.10	0.99	1.98	2.97	3.96	4.95	
	.20	0.88	1.76	2.64	3.52	4.40	

Interpolation is permissible.
 Correction Factor = $1.10 \times (1 - \text{BF}) \times (\text{edb} - 80)$.

- Cooling capacities are gross and do not include deduction for indoor fan motor heat.

COOLING CAPACITIES (cont)

48/50P2,P3,P4,P5075 (75 TON) HIGH-CAPACITY COIL — SUBCOOL MODE

Temp (F) Air Entering Condenser (Edb)		Evaporator Air Quantity — Cfm																			
		14,000					17,500					21,000					24,500				
		Evaporator Air — Ewb (F)																			
		75	72	67	62	57	75	72	67	62	57	75	72	67	62	57	75	72	67	62	57
75	TC	871	825	758	693	647	913	869	799	726	674	946	896	837	761	717	966	919	847	773	753
	SHC	277	330	421	508	606	296	363	472	572	660	317	391	530	644	717	333	421	561	697	753
	kW	57.3	56.1	54.4	53.0	52.4	58.6	57.3	55.5	53.5	52.5	59.5	58.1	56.5	54.5	53.5	60.2	58.8	56.8	54.8	54.4
	BF	0.00	0.02	0.02	0.02	0.03	0.07	0.04	0.03	0.03	0.09	0.07	0.05	0.04	0.05	0.17	0.08	0.06	0.06	0.07	0.26
85	TC	836	794	741	680	616	876	834	766	717	650	907	866	792	743	689	923	880	812	747	741
	SHC	250	306	411	502	580	268	336	447	569	636	289	369	493	633	689	302	392	539	677	741
	kW	62.1	61.0	59.7	58.6	57.2	63.3	62.1	60.3	59.3	57.5	64.2	63.0	61.0	59.9	58.4	64.8	63.5	61.6	59.9	60.0
	BF	0.00	0.02	0.02	0.02	0.04	0.07	0.04	0.03	0.03	0.10	0.07	0.05	0.04	0.05	0.18	0.08	0.06	0.06	0.07	0.27
95	TC	798	769	708	649	592	836	804	729	684	619	861	820	765	706	657	880	842	782	711	708
	SHC	222	291	387	480	559	238	317	420	546	607	255	334	477	606	657	271	365	520	647	708
	kW	67.7	67.0	65.6	64.6	64.0	68.9	68.0	65.9	65.1	63.3	69.7	68.4	67.0	65.5	64.1	70.3	69.1	67.4	65.5	65.7
	BF	0.03	0.02	0.02	0.02	0.05	0.07	0.04	0.03	0.03	0.12	0.07	0.05	0.04	0.05	0.20	0.08	0.06	0.06	0.08	0.28
105	TC	756	729	671	615	565	798	752	702	647	586	818	776	724	670	623	833	796	739	671	674
	SHC	192	263	362	456	533	214	277	405	519	576	226	304	448	580	623	239	333	490	610	674
	kW	74.2	73.5	72.6	72.1	72.0	75.4	74.1	73.0	72.3	70.7	76.1	74.8	73.4	72.5	71.3	76.6	75.4	73.8	72.0	72.7
	BF	0.03	0.02	0.02	0.02	0.07	0.06	0.04	0.03	0.04	0.13	0.07	0.05	0.05	0.05	0.22	0.08	0.06	0.06	0.10	0.30
115	TC	711	688	631	578	533	750	706	646	607	574	770	728	680	629	586	781	744	694	631	635
	SHC	162	235	334	429	504	183	247	362	492	568	194	272	418	551	586	205	297	460	573	635
	kW	82.0	81.7	81.0	81.0	81.3	83.0	81.8	80.6	80.9	80.9	83.6	82.4	81.4	81.0	79.8	84.0	82.8	81.7	80.1	81.0
	BF	0.02	0.02	0.02	0.02	0.09	0.06	0.04	0.03	0.04	0.15	0.07	0.05	0.05	0.06	0.23	0.08	0.06	0.06	0.12	0.31

48/50P2,P3,P4,P5075 (75 TON) HIGH-CAPACITY COIL — SUBCOOL MODE (cont)

Temp (F) Air Entering Condenser (Edb)		Evaporator Air Quantity — Cfm									
		28,000					30,000				
		Evaporator Air — Ewb (F)									
		75	72	67	62	57	75	72	67	62	57
75	TC	983	936	862	796	783	990	944	869	806	797
	SHC	351	449	611	755	783	360	465	636	777	797
	kW	60.7	59.4	57.3	55.5	55.2	60.9	59.6	57.5	55.8	55.6
	BF	0.09	0.08	0.07	0.10	0.33	0.10	0.08	0.08	0.13	0.36
85	TC	939	898	826	764	768	974	902	840	790	761
	SHC	320	422	583	721	768	369	434	615	762	761
	kW	65.4	64.1	62.0	60.3	60.6	69.7	64.2	62.4	61.2	60.1
	BF	0.09	0.08	0.07	0.11	0.34	0.12	0.08	0.08	0.14	0.37
95	TC	895	852	786	747	733	932	856	800	755	747
	SHC	289	388	554	706	733	346	395	586	729	747
	kW	70.8	69.5	67.6	66.7	66.3	75.8	69.6	68.0	66.9	66.7
	BF	0.09	0.08	0.07	0.13	0.35	0.12	0.08	0.08	0.15	0.38
105	TC	846	806	750	709	697	850	812	755	717	709
	SHC	251	356	532	671	697	273	371	555	693	709
	kW	77.0	75.8	74.2	73.2	73.0	77.2	76.0	74.4	73.4	73.2
	BF	0.10	0.08	0.07	0.14	0.36	0.10	0.08	0.08	0.16	0.40
115	TC	794	755	704	668	658	802	761	708	676	669
	SHC	220	323	500	634	658	222	338	523	656	669
	kW	84.4	83.2	81.9	81.3	81.2	84.6	83.4	82.0	81.4	81.4
	BF	0.09	0.08	0.07	0.16	0.38	0.10	0.08	0.08	0.18	0.41

LEGEND

48/50P3,P5 units only.

BF — Bypass Factor **kW** — Compressor Motor Power Input
Edb — Entering Dry Bulb **SHC** — Sensible Heat Cap. (1000 Btuh)
Ewb — Entering Wet Bulb **TC** — Total Cap. (1000 Btuh) Gross

NOTES:

1. The SHC is based on 80 F edb temperature of air entering evaporator coil. For edb temperatures other than 80 F, adjust SHC by multiplying the correction factor and the cfm and then adding or subtracting the value from the SHC.

2. Interpolation is permissible.
3. Correction Factor = $1.10 \times (1 - BF) \times (edb - 80)$.
4. Cooling capacities are gross and do not include deduction for indoor fan motor heat.
5. SHC values provided are in subcooling mode with the gas bypass valve closed and reflect the maximum SHC in subcooling mode. The P Series innovative modulating valve system can reduce SHC as needed to meet the supply air set point requirement with minimal change in latent capacity. This will provide variable SHC to meet the space load.

Performance data (cont)



COOLING CAPACITIES (cont)

48/50P2,P3,P4,P5075 (75 TON) HIGH-CAPACITY COIL — HOT GAS REHEAT MODE

Temp (F) Air Ent Condenser (Edb)		Air Entering Evaporator — Ewb (F)											
		75 Dry Bulb 62.5 Wet Bulb (50% RH)					75 Dry Bulb 65.3 Wet Bulb (60% RH)						
		Air Entering Evaporator — Cfm											
		14,000	17,500	21,000	24,500	28,000	30,000	14,000	17,500	21,000	24,500	28,000	30,000
80	TC	293	314	328	337	344	347	310	331	345	354	361	364
	SHC	22	51	83	117	151	170	-45	-27	-6	17	42	56
	kW	57.6	57.3	57.2	57.3	57.4	57.4	58.6	58.4	58.3	58.4	58.5	58.6
	BF	0.02	0.03	0.05	0.06	0.07	0.08	0.02	0.03	0.05	0.06	0.07	0.08
75	TC	300	321	335	344	351	354	317	338	351	361	368	371
	SHC	26	55	87	120	154	174	-41	-23	-2	21	45	60
	kW	55.7	55.5	55.4	55.5	55.6	55.7	56.8	56.6	56.7	56.8	56.8	56.9
	BF	0.02	0.03	0.05	0.06	0.07	0.08	0.02	0.03	0.05	0.06	0.07	0.08
70	TC	306	327	340	350	357	360	322	343	357	367	374	377
	SHC	30	59	90	124	158	177	-38	-20	1	24	49	63
	kW	53.9	53.8	53.9	54.0	54.1	54.2	55.2	55.0	55.1	55.3	55.4	55.5
	BF	0.02	0.03	0.05	0.06	0.07	0.08	0.02	0.03	0.05	0.06	0.07	0.08
60	TC	301	319	331	340	345	348	316	334	346	354	361	363
	SHC	29	57	89	121	155	174	-39	-22	-1	21	46	60
	kW	56.2	56.4	56.6	56.9	57.1	57.2	57.7	57.9	58.2	58.5	58.7	58.8
	BF	0.02	0.03	0.05	0.06	0.07	0.08	0.02	0.03	0.05	0.06	0.07	0.08
50	TC	312	330	342	350	357	359	326	345	357	366	372	375
	SHC	35	63	95	127	161	180	-33	-16	5	28	52	66
	kW	52.8	53.2	53.6	53.9	54.2	54.3	54.4	54.8	55.2	55.5	55.8	55.9
	BF	0.02	0.03	0.05	0.06	0.07	0.08	0.02	0.03	0.05	0.06	0.07	0.08
40	TC	319	338	350	359	366	369	334	353	366	375	382	385
	SHC	40	69	99	132	166	185	-28	-10	10	33	57	71
	kW	50.1	50.6	51.2	51.5	51.8	52.0	51.8	52.3	52.8	53.2	53.5	53.6
	BF	0.02	0.03	0.05	0.06	0.07	0.08	0.02	0.03	0.05	0.06	0.07	0.08

48/50P2,P3,P4,P5075 (75 TON) HIGH-CAPACITY COIL — HOT GAS REHEAT MODE (cont)

Temp (F) Air Ent Condenser (Edb)		Air Entering Evaporator — Ewb (F)											
		75 Dry Bulb 68 Wet Bulb (70% RH)					75 Dry Bulb 70.5 Wet Bulb (80% RH)						
		Air Entering Evaporator — Cfm											
		14,000	17,500	21,000	24,500	28,000	30,000	14,000	17,500	21,000	24,500	28,000	30,000
80	TC	327	348	362	371	378	381	342	363	377	387	394	398
	SHC	-111	-104	-93	-80	-65	-56	-174	-176	-175	-171	-165	-160
	kW	60.0	59.7	59.6	59.8	59.9	60.0	61.4	61.1	61.1	61.3	61.5	61.5
	BF	0.02	0.04	0.05	0.07	0.08	0.09	0.00	0.07	0.07	0.09	0.10	0.11
75	TC	333	354	368	377	385	388	348	370	384	393	401	405
	SHC	-107	-100	-90	-77	-62	-52	-170	-173	-172	-168	-161	-157
	kW	58.2	57.9	58.1	58.2	58.3	58.4	59.6	59.4	59.6	59.7	59.8	59.9
	BF	0.02	0.04	0.05	0.07	0.08	0.09	0.00	0.07	0.07	0.09	0.10	0.11
70	TC	339	360	374	383	391	395	354	375	390	400	409	413
	SHC	-104	-97	-87	-73	-58	-49	-167	-170	-168	-164	-158	-153
	kW	56.6	56.5	56.6	56.7	56.8	56.9	58.1	57.9	58.1	58.2	58.4	58.5
	BF	0.02	0.04	0.05	0.07	0.08	0.09	0.00	0.07	0.07	0.09	0.10	0.11
60	TC	330	349	361	370	376	379	344	363	376	384	391	394
	SHC	-106	-99	-89	-76	-61	-52	-169	-172	-171	-167	-161	-157
	kW	59.4	59.6	59.9	60.2	60.4	60.5	61.2	61.4	61.6	61.9	62.2	62.3
	BF	0.02	0.04	0.05	0.07	0.08	0.09	0.00	0.06	0.07	0.09	0.10	0.11
50	TC	341	360	372	381	388	391	355	375	387	396	403	407
	SHC	-99	-93	-83	-70	-55	-46	-162	-165	-165	-161	-155	-151
	kW	56.2	56.5	56.9	57.3	57.5	57.6	58.0	58.3	58.6	59.0	59.2	59.3
	BF	0.02	0.04	0.05	0.07	0.08	0.09	0.00	0.07	0.07	0.09	0.10	0.11
40	TC	349	369	382	392	400	404	364	384	398	409	417	421
	SHC	-94	-88	-78	-64	-49	-40	-157	-160	-159	-155	-149	-144
	kW	53.6	54.0	54.5	54.9	55.2	55.3	55.7	55.8	56.2	56.6	56.9	57.0
	BF	0.02	0.04	0.05	0.07	0.08	0.09	0.00	0.07	0.07	0.09	0.10	0.11

LEGEND

BF — Bypass Factor
Edb — Entering Dry Bulb
Ewb — Entering Wet Bulb
kW — Compressor Motor Power Input
RH — Relative Humidity
SHC — Sensible Heat Cap. (1000 Btu/h)
TC — Total Cap. (1000 Btu/h) Gross

6. SHC values provided reflect maximum reheat values with 100% gas bypass. Negative SHC value indicates that the air entering the coil is being heated at 100% gas bypass. The P Series innovative modulating valve system will reduce the gas bypass as required to meet the supply air setpoint with minimal change in latent capacity. The space will NOT be overheated and the unit will provide variable SHC to meet the space load.

NOTES:

- The SHC is based on 75 F edb temperature of air entering evaporator coil. For edb temperatures other than 75 F, adjust SHC by multiplying the correction factor and the cfm and then adding or subtracting the value from the SHC.
- Interpolation is permissible.
- Correction Factor = $1.10 \times (1 - BF) \times (edb - 75)$.
- Cooling capacities are gross and do not include deduction for indoor fan motor heat.
- Capacity table includes impact of outdoor fan staging at temperatures below 75 F.

COOLING CAPACITIES (cont)

48/50P2,P3,P4,P5090 (90 TON) STANDARD CAPACITY COIL — STANDARD MODE

Temp (F) Air Entering Condenser (Edb)		Evaporator Air Quantity — Cfm																			
		18,000					22,500					27,000					31,500				
		Evaporator Air — Ewb (F)																			
		75	72	67	62	57	75	72	67	62	57	75	72	67	62	57	75	72	67	62	57
75	TC	1118	1070	985	903	822	1173	1118	1032	950	884	1204	1152	1066	981	922	1231	1175	1090	1005	970
	SHC	460	513	614	709	790	474	553	674	790	858	501	590	729	863	922	525	624	781	928	970
	KW	61.5	60.5	59.0	57.8	56.7	62.6	61.5	59.9	58.6	57.4	63.3	62.2	60.6	59.2	58.2	63.9	62.8	61.1	59.6	58.9
	BF	0.00	0.00	0.13	0.10	0.11	0.00	0.21	0.13	0.11	0.21	0.00	0.18	0.14	0.13	0.25	0.25	0.17	0.15	0.15	0.34
85	TC	1086	1037	954	873	791	1135	1083	998	917	847	1165	1112	1030	947	899	1187	1137	1052	970	942
	SHC	444	501	600	694	759	461	540	659	775	847	489	576	714	846	899	512	609	766	911	942
	KW	68.1	67.1	65.8	64.6	63.3	69.1	68.1	66.6	65.4	64.2	69.8	68.7	67.2	66.0	65.1	70.3	69.3	67.7	66.4	65.8
	BF	0.00	0.00	0.13	0.10	0.10	0.00	0.19	0.13	0.11	0.19	0.30	0.16	0.14	0.13	0.28	0.22	0.17	0.15	0.16	0.36
95	TC	1050	1001	920	841	763	1093	1044	961	882	827	1122	1073	990	909	873	1144	1093	1011	930	910
	SHC	430	488	585	678	748	450	526	644	758	810	475	561	699	828	873	498	594	750	888	910
	KW	75.7	74.7	73.6	72.3	71.3	76.7	75.8	74.4	73.1	72.1	77.4	76.5	75.0	73.7	72.9	77.9	76.9	75.4	74.1	73.7
	BF	0.00	0.26	0.12	0.09	0.12	0.00	0.17	0.12	0.11	0.25	0.24	0.16	0.13	0.13	0.30	0.21	0.16	0.15	0.16	0.38
105	TC	1010	961	881	806	734	1048	1000	919	842	791	1075	1026	946	867	839	1095	1046	965	886	874
	SHC	411	472	568	663	729	436	510	626	739	791	460	546	681	807	839	482	578	732	859	874
	KW	84.5	83.7	82.4	81.3	81.1	85.4	84.6	83.2	82.2	81.8	86.1	85.1	83.8	82.8	82.0	86.6	85.7	84.2	82.9	82.6
	BF	0.00	0.20	0.11	0.08	0.14	0.00	0.15	0.12	0.11	0.24	0.21	0.15	0.13	0.13	0.33	0.19	0.16	0.14	0.18	0.40
115	TC	963	914	838	768	713	997	950	872	797	758	1021	974	896	821	802	1039	992	914	839	837
	SHC	391	454	550	647	693	420	492	607	718	758	443	527	661	784	802	465	560	712	833	837
	KW	94.5	93.7	93.5	92.2	92.2	95.3	94.5	93.9	94.0	93.5	96.0	95.2	94.2	93.8	93.8	96.5	95.6	94.5	94.1	94.0
	BF	0.00	0.16	0.10	0.08	0.20	0.24	0.14	0.11	0.11	0.28	0.18	0.14	0.13	0.14	0.36	0.18	0.15	0.14	0.19	0.43

48/50P2,P3,P4,P5090 (90 TON) STANDARD CAPACITY COIL — STANDARD MODE (cont)

Temp (F) Air Entering Condenser (Edb)		Evaporator Air Quantity — Cfm				
		36,000				
		Evaporator Air — Ewb (F)				
		75	72	67	62	57
75	TC	1251	1195	1109	1023	1004
	SHC	547	656	831	983	1004
	KW	64.3	63.2	61.4	59.9	59.6
	BF	0.22	0.17	0.16	0.18	0.40
85	TC	1208	1153	1070	986	974
	SHC	534	641	816	962	974
	KW	70.7	69.6	68.1	66.7	66.4
	BF	0.21	0.17	0.16	0.19	0.42
95	TC	1161	1110	1027	948	942
	SHC	519	626	800	929	942
	KW	78.3	77.3	75.8	74.4	74.3
	BF	0.20	0.17	0.16	0.22	0.44
105	TC	1110	1061	980	908	905
	SHC	503	609	781	899	905
	KW	87.0	86.1	84.6	83.2	83.2
	BF	0.19	0.17	0.16	0.24	0.46
115	TC	1052	1005	927	867	864
	SHC	485	589	762	860	864
	KW	96.8	96.0	94.8	94.2	94.3
	BF	0.18	0.17	0.16	0.27	0.48

LEGEND

- 48/50P3,P5 units only.
- BF** — Bypass Factor **KW** — Compressor Motor Power Input
Edb — Entering Dry Bulb **SHC** — Sensible Heat Cap. (1000 Btuh)
Ewb — Entering Wet Bulb **TC** — Total Cap. (1000 Btuh) Gross

NOTES:

- Direct interpolation is permissible. Do not extrapolate.
- The following formulas may be used:

$$t_{ldb} = t_{edb} - \frac{\text{sensible capacity (Btuh)}}{1.10 \times \text{cfm}}$$

$$t_{lwb} = \text{Wet-bulb temperature corresponding to enthalpy of air leaving evaporator coil } (h_{lwb}).$$

$$h_{lwb} = h_{ewb} - \frac{\text{total capacity (Btuh)}}{4.5 \times \text{cfm}}$$

- Where: h_{ewb} = Enthalpy of air entering evaporator coil.
- SHC is based on 80 F edb temperature of air entering evaporator coil. Below 80 F edb, subtract (corr factor x cfm) from SHC. Above 80 F edb, add (corr factor x cfm) to SHC.

BF		ENTERING AIR DRY-BULB TEMP (F)					
		79	78	77	76	75	under 75
		81	82	83	84	85	over 85
Correction Factor							
.05	1.04	2.09	3.14	4.18	5.22	Use formula shown below	
.10	0.99	1.98	2.97	3.96	4.95		
.20	0.88	1.76	2.64	3.52	4.40		

Interpolation is permissible.
 Correction Factor = $1.10 \times (1 - \text{BF}) \times (\text{edb} - 80)$.

- Cooling capacities are gross and do not include deduction for indoor fan motor heat.

Performance data (cont)



COOLING CAPACITIES (cont)

48/50P2,P3,P4,P5090 (90 TON) STANDARD CAPACITY COIL — SUBCOOL MODE

Temp (F) Air Entering Condenser (Edb)		Evaporator Air Quantity — Cfm																			
		18,000					22,500					27,000					31,500				
		Evaporator Air — Ewb (F)																			
		75	72	67	62	57	75	72	67	62	57	75	72	67	62	57	75	72	67	62	57
75	TC	1075	1017	922	863	788	1154	1072	1003	915	836	1171	1135	1017	925	883	1201	1142	1045	952	923
	SHC	396	454	541	656	744	450	493	629	736	819	452	553	658	782	883	475	563	707	846	923
	kW	61.1	60.1	58.5	58.1	57.2	62.8	61.1	60.3	58.8	57.7	63.0	62.5	60.2	58.6	58.4	63.6	62.4	60.7	59.1	59.0
	BF	0.00	0.05	0.09	0.10	0.11	0.03	0.10	0.12	0.12	0.18	0.09	0.12	0.14	0.15	0.26	0.12	0.15	0.16	0.17	0.33
85	TC	1052	964	884	828	752	1080	1013	933	876	807	1117	1083	995	910	844	1144	1088	996	935	887
	SHC	387	413	513	629	712	391	449	570	707	791	414	516	649	778	844	436	525	673	841	887
	kW	68.2	66.3	64.9	64.9	64.0	68.5	67.3	65.8	65.5	64.6	69.2	68.8	67.3	65.9	65.1	69.8	68.7	67.0	66.4	65.7
	BF	0.00	0.06	0.09	0.10	0.11	0.04	0.10	0.12	0.12	0.19	0.09	0.13	0.14	0.15	0.26	0.12	0.15	0.16	0.18	0.34
95	TC	977	950	868	790	718	1026	972	914	835	771	1080	1006	946	866	808	1086	1053	944	890	849
	SHC	327	413	508	600	686	354	423	564	677	756	396	456	615	746	808	396	508	637	807	849
	kW	74.7	74.6	73.6	72.8	71.9	75.7	74.6	74.1	73.3	72.4	77.0	75.3	74.6	73.6	73.0	77.0	76.5	74.2	73.9	73.5
	BF	0.00	0.06	0.09	0.10	0.11	0.04	0.10	0.12	0.12	0.20	0.09	0.13	0.14	0.15	0.28	0.12	0.15	0.16	0.18	0.35
105	TC	924	839	823	750	689	991	943	865	790	734	1000	972	894	819	770	1041	993	916	843	807
	SHC	291	315	476	570	656	337	410	529	645	721	336	440	579	712	770	372	468	625	773	807
	kW	83.0	81.6	82.5	81.9	81.1	84.5	83.8	82.9	82.2	81.5	84.5	84.2	83.3	82.5	82.0	85.6	84.6	83.5	82.8	82.4
	BF	0.00	0.06	0.09	0.10	0.15	0.05	0.10	0.12	0.12	0.22	0.09	0.13	0.14	0.15	0.30	0.12	0.15	0.16	0.19	0.37
115	TC	868	848	774	708	648	931	886	812	742	694	956	912	838	769	728	974	930	858	790	762
	SHC	253	342	442	544	617	297	371	493	611	682	313	399	540	675	728	329	426	586	728	762
	kW	92.8	93.3	92.8	92.4	91.8	94.2	93.7	93.0	92.6	92.0	94.5	94.0	93.3	92.7	92.5	94.8	94.2	93.4	92.9	92.7
	BF	0.00	0.06	0.09	0.10	0.16	0.05	0.10	0.12	0.13	0.24	0.10	0.13	0.14	0.16	0.31	0.13	0.15	0.16	0.20	0.39

48/50P2,P3,P4,P5090 (90 TON) STANDARD CAPACITY COIL — SUBCOOL MODE (cont)

Temp (F) Air Entering Condenser (Edb)		Evaporator Air Quantity — Cfm				
		36,000				
		Evaporator Air — Ewb (F)				
		75	72	67	62	57
75	TC	1209	1164	1068	972	932
	SHC	481	594	757	903	932
	kW	63.8	62.9	61.2	59.5	58.7
	BF	0.15	0.17	0.18	0.20	0.39
85	TC	1165	1109	1041	929	923
	SHC	456	555	745	869	923
	kW	70.2	69.1	68.1	65.8	66.2
	BF	0.15	0.17	0.18	0.21	0.40
95	TC	1105	1051	963	908	882
	SHC	415	516	683	863	882
	kW	77.4	76.3	74.6	74.2	73.9
	BF	0.15	0.17	0.18	0.21	0.41
105	TC	1041	990	932	860	838
	SHC	373	475	669	815	838
	kW	85.5	84.4	83.8	82.9	82.7
	BF	0.15	0.17	0.18	0.23	0.43
115	TC	973	926	872	810	791
	SHC	329	433	629	767	791
	kW	94.6	93.8	93.6	93.0	92.9
	BF	0.15	0.17	0.18	0.25	0.44

LEGEND

48/50P3,P5 units only.

BF — Bypass Factor **kW** — Compressor Motor Power Input
Edb — Entering Dry Bulb **SHC** — Sensible Heat Cap. (1000 Btuh)
Ewb — Entering Wet Bulb **TC** — Total Cap. (1000 Btuh) Gross

NOTES:

- The SHC is based on 80 F edb temperature of air entering evaporator coil. For edb temperatures other than 80 F, adjust SHC by multiplying the correction factor and the cfm and then adding or subtracting the value from the SHC.

- Interpolation is permissible.
- Correction Factor = $1.10 \times (1 - BF) \times (edb - 80)$.
- Cooling capacities are gross and do not include deduction for indoor fan motor heat.
- SHC values provided are in subcooling mode with the gas bypass valve closed and reflect the maximum SHC in subcooling mode. The P Series innovative modulating valve system can reduce SHC as needed to meet the supply air set point requirement with minimal change in latent capacity. This will provide variable SHC to meet the space load.

COOLING CAPACITIES (cont)

48/50P2,P3,P4,P5090 (90 TON) STANDARD CAPACITY COIL — HOT GAS REHEAT MODE

Temp (F) Air Ent Condenser (Edb)		Air Entering Evaporator — Ewb (F)									
		75 Dry Bulb 62.5 Wet Bulb (50% RH)					75 Dry Bulb 65.3 Wet Bulb (60% RH)				
		Air Entering Evaporator — Cfm									
		18,000	22,500	27,000	31,500	36,000	18,000	22,500	27,000	31,500	36,000
80	TC	362	390	410	425	436	385	415	436	451	463
	SHC	60	95	131	166	202	-9	14	39	63	90
	kW	64.0	63.6	63.5	63.4	63.4	65.3	64.9	64.7	64.8	64.7
	BF	0.09	0.12	0.14	0.16	0.18	0.08	0.11	0.14	0.16	0.18
75	TC	371	400	421	436	448	395	425	446	462	474
	SHC	66	101	137	173	209	-3	21	47	73	100
	kW	61.6	61.3	61.2	61.3	61.3	63.0	62.7	62.6	62.7	62.9
	BF	0.09	0.12	0.14	0.16	0.18	0.08	0.11	0.14	0.16	0.18
70	TC	377	406	426	440	452	400	430	451	465	477
	SHC	71	106	142	178	214	1	25	50	78	105
	kW	61.6	61.4	61.4	61.6	61.8	63.1	62.9	63.0	63.4	63.7
	BF	0.09	0.12	0.14	0.16	0.18	0.08	0.11	0.14	0.16	0.18
60	TC	389	418	438	453	464	411	441	462	477	488
	SHC	82	117	154	190	228	14	39	66	93	122
	kW	59.4	59.5	60.0	60.4	60.7	61.2	61.6	62.1	62.4	62.8
	BF	0.09	0.12	0.14	0.16	0.18	0.08	0.11	0.14	0.16	0.18
50	TC	397	425	445	459	470	419	448	468	482	493
	SHC	91	127	165	203	241	24	51	80	109	139
	kW	58.4	59.1	59.7	60.2	60.6	60.7	61.3	61.9	62.4	62.8
	BF	0.09	0.12	0.14	0.16	0.18	0.08	0.11	0.14	0.16	0.18
40	TC	411	441	462	477	488	434	464	485	501	513
	SHC	101	139	177	215	253	36	63	91	120	150
	kW	55.3	56.0	56.6	57.1	57.5	57.5	58.1	58.7	59.2	59.6
	BF	0.09	0.12	0.14	0.17	0.18	0.08	0.11	0.14	0.16	0.18

48/50P2,P3,P4,P5090 (90 TON) STANDARD CAPACITY COIL — HOT GAS REHEAT MODE (cont)

Temp (F) Air Ent Condenser (Edb)		Air Entering Evaporator — Ewb (F)									
		75 Dry Bulb 68 Wet Bulb (70% RH)					75 Dry Bulb 70.5 Wet Bulb (80% RH)				
		Air Entering Evaporator — Cfm									
		18,000	22,500	27,000	31,500	36,000	18,000	22,500	27,000	31,500	36,000
80	TC	409	440	461	477	490	432	463	485	502	514
	SHC	-76	-64	-51	-35	-15	-139	-134	-129	-121	-112
	kW	66.7	66.2	66.2	66.2	66.3	68.2	67.8	67.8	67.9	68.0
	BF	0.06	0.10	0.13	0.15	0.17	0.00	0.04	0.09	0.12	0.15
75	TC	418	450	472	488	501	441	473	496	513	526
	SHC	-68	-55	-40	-23	-5	-130	-125	-118	-110	-101
	kW	64.5	64.3	64.4	64.6	64.7	66.3	66.1	66.2	66.4	66.5
	BF	0.06	0.10	0.13	0.15	0.17	0.00	0.04	0.09	0.12	0.15
70	TC	423	453	475	490	502	444	476	498	514	527
	SHC	-63	-49	-34	-16	2	-124	-119	-111	-102	-94
	kW	64.8	64.9	65.1	65.4	65.6	66.8	66.9	67.1	67.3	67.4
	BF	0.06	0.10	0.13	0.15	0.17	0.00	0.04	0.09	0.12	0.15
60	TC	434	464	486	501	513	455	487	508	524	536
	SHC	-50	-35	-17	2	23	-109	-100	-91	-80	-70
	kW	63.4	63.8	64.2	64.5	64.8	65.6	65.9	66.2	66.5	66.7
	BF	0.06	0.10	0.13	0.15	0.17	0.00	0.05	0.09	0.13	0.15
50	TC	440	470	491	505	516	461	491	512	527	538
	SHC	-38	-20	0	21	43	-93	-82	-70	-57	-47
	kW	63.1	63.6	64.2	64.6	65.0	65.4	65.9	66.4	66.8	67.1
	BF	0.06	0.10	0.13	0.15	0.17	0.01	0.05	0.10	0.13	0.15
40	TC	456	487	509	525	537	477	509	531	547	559
	SHC	-26	-9	11	31	52	-84	-74	-62	-50	-38
	kW	59.7	60.3	60.8	61.3	61.7	61.9	62.4	62.9	63.3	63.6
	BF	0.05	0.10	0.13	0.15	0.17	0.00	0.04	0.09	0.12	0.15

LEGEND

- | | |
|--|--|
| BF — Bypass Factor | RH — Relative Humidity |
| Edb — Entering Dry Bulb | SHC — Sensible Heat Cap. (1000 Btu/h) |
| Ewb — Entering Wet Bulb | TC — Total Cap. (1000 Btu/h) Gross |
| kW — Compressor Motor Power Input | |

6. SHC values provided reflect maximum reheat values with 100% gas bypass. Negative SHC value indicates that the air entering the coil is being heated at 100% gas bypass. The P Series innovative modulating valve system will reduce the gas bypass as required to meet the supply air setpoint with minimal change in latent capacity. The space will NOT be overheated and the unit will provide variable SHC to meet the space load.

NOTES:

- The SHC is based on 75 F edb temperature of air entering evaporator coil. For edb temperatures other than 75 F, adjust SHC by multiplying the correction factor and the cfm and then adding or subtracting the value from the SHC.
- Interpolation is permissible.
- Correction Factor = 1.10 x (1 - BF) x (edb - 75).
- Cooling capacities are gross and do not include deduction for indoor fan motor heat.
- Capacity table includes impact of outdoor fan staging at temperatures below 75 F.

Performance data (cont)



COOLING CAPACITIES (cont)

48/50P2,P3,P4,P5090 (90 TON) HIGH-CAPACITY COIL — STANDARD MODE

Temp (F) Air Entering Condenser (Edb)		Evaporator Air Quantity — Cfm																			
		18,000					22,500					27,000					31,500				
		Evaporator Air — Ewb (F)																			
		75	72	67	62	57	75	72	67	62	57	75	72	67	62	57	75	72	67	62	57
75	TC	1177	1117	1025	946	870	1238	1176	1081	999	929	1279	1214	1119	1036	984	1309	1246	1147	1061	1031
	SHC	486	546	648	750	843	512	591	717	843	921	542	633	781	927	984	569	672	842	1004	1031
	KW	63.2	62.0	60.0	58.4	57.0	64.6	63.2	61.2	59.5	58.1	65.4	64.1	62.0	60.2	59.2	66.1	64.7	62.6	60.8	60.2
	BF	0.00	0.13	0.04	0.03	0.04	0.00	0.08	0.04	0.04	0.13	0.13	0.06	0.05	0.05	0.22	0.10	0.07	0.06	0.07	0.30
85	TC	1138	1081	1000	922	846	1191	1133	1051	971	908	1228	1167	1087	1005	962	1255	1198	1113	1028	1006
	SHC	465	531	636	738	828	496	575	704	830	908	525	616	768	912	962	551	655	829	986	1006
	KW	69.7	68.4	66.6	65.1	63.8	70.9	69.6	67.8	66.2	64.9	71.7	70.4	68.6	66.9	65.9	72.3	71.0	69.2	67.4	66.9
	BF	0.00	0.10	0.04	0.03	0.04	0.00	0.07	0.04	0.03	0.13	0.11	0.06	0.05	0.05	0.24	0.09	0.07	0.06	0.07	0.31
95	TC	1100	1050	971	894	819	1151	1092	1018	940	883	1185	1134	1051	971	936	1208	1153	1075	994	979
	SHC	450	518	623	723	810	483	560	690	814	883	510	602	754	895	936	535	640	813	968	979
	KW	77.1	76.0	74.4	73.1	71.5	78.3	77.0	75.5	74.1	72.7	79.2	78.0	76.3	74.8	73.8	79.8	78.5	76.9	75.2	74.8
	BF	0.00	0.08	0.04	0.03	0.05	0.17	0.06	0.04	0.03	0.16	0.10	0.06	0.05	0.05	0.26	0.09	0.06	0.05	0.08	0.33
105	TC	1064	1014	936	858	792	1110	1060	980	900	854	1140	1091	1009	930	905	1161	1104	1031	952	946
	SHC	434	504	607	706	780	469	547	674	794	854	495	586	736	875	905	520	623	797	941	946
	KW	85.9	84.9	83.5	82.3	80.5	87.2	86.1	84.6	83.3	82.0	88.0	86.9	85.4	83.9	83.1	88.5	87.1	86.0	84.2	83.9
	BF	0.00	0.07	0.04	0.02	0.09	0.13	0.06	0.04	0.04	0.19	0.09	0.06	0.05	0.05	0.28	0.08	0.06	0.05	0.09	0.36
115	TC	1019	967	893	816	756	1061	1012	932	855	820	1087	1039	960	882	868	1108	1059	979	910	906
	SHC	422	486	588	685	756	452	528	654	773	820	477	568	716	852	868	502	605	776	899	906
	KW	96.1	94.7	94.2	94.4	92.7	97.4	96.4	95.3	95.2	93.4	98.2	97.2	96.1	94.4	94.2	98.8	97.8	96.7	95.0	94.8
	BF	0.00	0.05	0.03	0.03	0.10	0.10	0.06	0.04	0.04	0.22	0.08	0.06	0.05	0.06	0.31	0.08	0.06	0.05	0.13	0.38

48/50P2,P3,P4,P5090 (90 TON) HIGH-CAPACITY COIL — STANDARD MODE (cont)

Temp (F) Air Entering Condenser (Edb)		Evaporator Air Quantity — Cfm				
		36,000				
		Evaporator Air — Ewb (F)				
		75	72	67	62	57
75	TC	1331	1267	1169	1081	1069
	SHC	593	711	903	1066	1069
	KW	66.6	65.2	63.0	61.2	61.1
	BF	0.10	0.07	0.06	0.10	0.36
85	TC	1276	1218	1133	1048	1043
	SHC	575	692	889	1042	1043
	KW	72.8	71.5	69.6	67.8	67.7
	BF	0.09	0.07	0.06	0.11	0.38
95	TC	1231	1177	1093	1017	1014
	SHC	560	678	873	1007	1014
	KW	80.3	79.1	77.4	75.6	75.6
	BF	0.09	0.07	0.06	0.15	0.40
105	TC	1182	1129	1047	983	979
	SHC	544	661	855	968	979
	KW	89.1	88.0	86.4	84.8	84.7
	BF	0.09	0.07	0.06	0.18	0.42
115	TC	1126	1073	993	938	937
	SHC	526	642	832	938	937
	KW	99.5	98.3	97.4	95.3	95.3
	BF	0.08	0.07	0.06	0.20	0.44

LEGEND

48/50P3,P5 units only.

BF — Bypass Factor kW — Compressor Motor Power Input
 Edb — Entering Dry Bulb SHC — Sensible Heat Cap. (1000 Btuh)
 Ewb — Entering Wet Bulb TC — Total Cap. (1000 Btuh) Gross

NOTES:

- Direct interpolation is permissible. Do not extrapolate.
- The following formulas may be used:

$$t_{ldb} = t_{edb} - \frac{\text{sensible capacity (Btuh)}}{1.10 \times \text{cfm}}$$

$$t_{lwb} = \text{Wet-bulb temperature corresponding to enthalpy of air leaving evaporator coil (} h_{lwb} \text{).}$$

$$h_{lwb} = h_{ewb} - \frac{\text{total capacity (Btuh)}}{4.5 \times \text{cfm}}$$

Where: h_{ewb} = Enthalpy of air entering evaporator coil.

- SHC is based on 80 F edb temperature of air entering evaporator coil. Below 80 F edb, subtract (corr factor x cfm) from SHC. Above 80 F edb, add (corr factor x cfm) to SHC.

BF	ENTERING AIR DRY-BULB TEMP (F)					
	79	78	77	76	75	under 75
	81	82	83	84	85	over 85
Correction Factor						
.05	1.04	2.09	3.14	4.18	5.22	Use formula shown below
.10	0.99	1.98	2.97	3.96	4.95	
.20	0.88	1.76	2.64	3.52	4.40	

Interpolation is permissible.

$$\text{Correction Factor} = 1.10 \times (1 - \text{BF}) \times (\text{edb} - 80).$$

- Cooling capacities are gross and do not include deduction for indoor fan motor heat.

COOLING CAPACITIES (cont)

48/50P2,P3,P4,P5090 (90 TON) HIGH-CAPACITY COIL — SUBCOOL MODE

Temp (F) Air Entering Condenser (Edb)		Evaporator Air Quantity — Cfm																			
		18,000					22,500					27,000					31,500				
		Evaporator Air — Ewb (F)																			
		75	72	67	62	57	75	72	67	62	57	75	72	67	62	57	75	72	67	62	57
75	TC	1134	1074	981	894	822	1191	1131	1036	948	878	1230	1170	1075	985	932	1259	1198	1103	1014	974
	SHC	398	462	566	668	773	425	503	630	755	859	450	540	690	837	932	474	577	748	911	974
	kW BF	62.5 0.00	61.4 0.01	59.7 0.02	58.3 0.03	57.4 0.04	63.6 0.00	62.5 0.03	60.7 0.04	59.2 0.04	57.9 0.10	64.5 0.03	63.3 0.05	61.5 0.05	59.9 0.06	58.9 0.18	65.1 0.05	63.9 0.06	62.0 0.06	60.4 0.08	59.7 0.26
85	TC	1080	1023	935	853	781	1133	1076	985	902	843	1169	1111	1021	937	886	1196	1138	1046	964	930
	SHC	358	424	531	636	736	383	462	592	721	826	406	498	650	800	886	429	533	706	872	930
	kW BF	68.8 0.00	67.2 0.01	66.2 0.02	65.3 0.03	64.5 0.04	69.9 0.01	68.8 0.03	67.1 0.04	65.8 0.11	64.9 0.11	70.7 0.03	69.5 0.05	67.8 0.05	66.2 0.06	65.6 0.19	71.3 0.05	70.1 0.06	68.3 0.06	66.7 0.08	66.1 0.27
95	TC	1025	970	887	810	743	1072	1018	933	855	801	1105	1050	965	887	843	1129	1074	988	912	885
	SHC	318	386	495	603	702	340	420	554	685	785	361	454	610	762	843	382	487	664	831	885
	kW BF	76.1 0.00	75.2 0.01	74.2 0.02	73.6 0.03	73.0 0.06	77.1 0.01	76.0 0.03	74.7 0.04	73.2 0.12	73.2 0.14	77.9 0.04	76.7 0.05	75.2 0.05	74.2 0.06	73.8 0.20	78.4 0.06	77.3 0.06	75.5 0.06	74.5 0.09	74.1 0.29
105	TC	965	914	835	762	710	1008	957	877	804	758	1036	986	905	834	798	1058	1006	926	858	836
	SHC	277	345	458	568	672	295	377	513	648	744	313	409	567	722	798	332	440	620	793	836
	kW BF	84.9 0.00	84.4 0.01	83.8 0.02	83.7 0.03	83.4 0.08	85.5 0.01	84.8 0.03	84.1 0.04	83.2 0.14	83.2 0.14	86.0 0.04	85.2 0.05	84.3 0.05	83.7 0.06	83.5 0.22	86.5 0.06	85.5 0.06	84.5 0.06	83.8 0.10	83.6 0.30
115	TC	903	855	780	714	664	940	892	817	748	712	965	917	842	777	748	984	935	860	803	783
	SHC	233	304	418	536	626	248	332	471	608	700	264	361	523	680	748	282	391	575	735	783
	kW BF	95.3 0.00	95.0 0.01	95.0 0.02	95.6 0.03	95.6 0.10	95.7 0.01	95.2 0.03	94.9 0.04	95.1 0.05	94.9 0.16	96.0 0.04	95.4 0.05	94.9 0.05	94.8 0.07	94.9 0.24	96.3 0.06	95.6 0.06	95.0 0.07	94.6 0.12	94.7 0.32

48/50P2,P3,P4,P5090 (90 TON) HIGH-CAPACITY COIL — SUBCOOL MODE (cont)

Temp (F) Air Entering Condenser (Edb)		Evaporator Air Quantity — Cfm				
		36,000				
		Evaporator Air — Ewb (F)				
		75	72	67	62	57
75	TC	1281	1220	1124	1038	1014
	SHC	497	611	803	978	1014
	kW BF	65.6 0.07	64.4 0.07	62.5 0.08	60.9 0.11	60.4 0.33
85	TC	1216	1157	1066	986	967
	SHC	450	566	760	935	967
	kW BF	71.8 0.07	70.5 0.08	68.7 0.08	67.2 0.11	66.8 0.34
95	TC	1148	1092	1005	934	919
	SHC	402	520	717	888	919
	kW BF	78.8 0.07	77.7 0.08	75.9 0.08	74.7 0.13	74.5 0.35
105	TC	1074	1022	942	881	867
	SHC	352	471	672	837	867
	kW BF	86.9 0.07	85.8 0.08	84.7 0.08	83.9 0.14	83.8 0.37
115	TC	998	949	874	824	812
	SHC	300	421	624	783	812
	kW BF	96.5 0.07	95.8 0.08	95.0 0.08	94.6 0.16	94.6 0.38

LEGEND

48/50P3,P5 units only.

BF — Bypass Factor **kW** — Compressor Motor Power Input
Edb — Entering Dry Bulb **SHC** — Sensible Heat Cap. (1000 Btuh)
Ewb — Entering Wet Bulb **TC** — Total Cap. (1000 Btuh) Gross

NOTES:

- The SHC is based on 80 F edb temperature of air entering evaporator coil. For edb temperatures other than 80 F, adjust SHC by multiplying the correction factor and the cfm and then adding or subtracting the value from the SHC.

- Interpolation is permissible.
- Correction Factor = $1.10 \times (1 - BF) \times (edb - 80)$.
- Cooling capacities are gross and do not include deduction for indoor fan motor heat.
- SHC values provided are in subcooling mode with the gas bypass valve closed and reflect the maximum SHC in subcooling mode. The P Series innovative modulating valve system can reduce SHC as needed to meet the supply air set point requirement with minimal change in latent capacity. This will provide variable SHC to meet the space load.

Performance data (cont)



COOLING CAPACITIES (cont)

48/50P2,P3,P4,P5090 (90 TON) HIGH-CAPACITY COIL — HOT GAS REHEAT MODE

Temp (F) Air Ent Condenser (Edb)		Air Entering Evaporator — Ewb (F)									
		75 Dry Bulb 62.5 Wet Bulb (50% RH)					75 Dry Bulb 65.3 Wet Bulb (60% RH)				
		Air Entering Evaporator — Cfm									
		18,000	22,500	27,000	31,500	36,000	18,000	22,500	27,000	31,500	36,000
80	TC	386	417	437	452	464	410	442	463	478	490
	SHC	61	100	141	184	227	-16	11	39	68	102
	kW	65.8	65.2	65.0	64.9	64.9	67.2	66.6	66.5	66.5	66.5
	BF	0.03	0.04	0.05	0.07	0.08	0.02	0.04	0.05	0.06	0.08
75	TC	396	427	448	463	475	420	452	474	490	502
	SHC	67	107	148	191	235	-9	18	47	78	111
	kW	63.3	62.8	62.7	62.8	62.9	64.8	64.4	64.5	64.7	64.9
	BF	0.03	0.04	0.05	0.06	0.08	0.02	0.04	0.05	0.06	0.08
70	TC	401	431	452	467	478	425	456	477	492	503
	SHC	71	111	152	196	239	-5	22	52	83	115
	kW	63.3	63.1	63.1	63.4	63.7	65.0	64.9	65.2	65.5	65.7
	BF	0.03	0.04	0.05	0.06	0.08	0.02	0.04	0.05	0.06	0.08
60	TC	413	443	463	478	488	436	467	487	502	513
	SHC	81	121	163	207	250	5	33	63	94	128
	kW	61.1	61.4	61.9	62.3	62.6	63.3	63.7	64.1	64.4	64.7
	BF	0.03	0.04	0.05	0.06	0.08	0.02	0.04	0.05	0.06	0.08
50	TC	421	449	469	482	492	442	472	491	505	516
	SHC	89	129	171	215	260	13	41	71	104	138
	kW	60.3	61.0	61.6	62.1	62.5	62.8	63.4	64.0	64.4	64.8
	BF	0.03	0.04	0.05	0.07	0.08	0.02	0.04	0.05	0.06	0.08
40	TC	434	464	484	498	508	456	487	507	522	533
	SHC	100	142	186	231	276	25	55	87	121	155
	kW	57.3	58.1	58.7	59.2	59.6	59.7	60.4	61.0	61.5	61.8
	BF	0.03	0.04	0.05	0.07	0.08	0.02	0.04	0.05	0.06	0.08

48/50P2,P3,P4,P5090 (90 TON) HIGH-CAPACITY COIL — HOT GAS REHEAT MODE (cont)

Temp (F) Air Ent Condenser (Edb)		Air Entering Evaporator — Ewb (F)									
		75 Dry Bulb 68 Wet Bulb (70% RH)					75 Dry Bulb 70.5 Wet Bulb (80% RH)				
		Air Entering Evaporator — Cfm									
		18,000	22,500	27,000	31,500	36,000	18,000	22,500	27,000	31,500	36,000
80	TC	435	467	489	505	517	458	491	513	530	542
	SHC	-89	-76	-61	-42	-19	-159	-156	-150	-141	-131
	kW	68.8	68.3	68.3	68.3	68.4	70.5	70.1	70.1	70.2	70.3
	BF	0.01	0.03	0.05	0.06	0.08	0.00	0.01	0.04	0.06	0.07
75	TC	445	478	500	516	529	468	502	525	542	554
	SHC	-82	-68	-50	-31	-10	-151	-147	-141	-132	-123
	kW	66.6	66.4	66.5	66.7	66.8	68.5	68.3	68.4	68.5	68.6
	BF	0.01	0.03	0.05	0.06	0.08	0.00	0.01	0.04	0.06	0.07
70	TC	448	480	501	517	528	471	503	525	541	552
	SHC	-78	-64	-46	-27	-5	-147	-143	-137	-128	-118
	kW	66.9	67.1	67.3	67.5	67.7	69.1	69.2	69.3	69.5	69.6
	BF	0.01	0.03	0.05	0.06	0.08	0.00	0.01	0.04	0.06	0.07
60	TC	459	490	511	526	537	481	512	534	549	560
	SHC	-67	-53	-35	-14	8	-137	-132	-125	-115	-105
	kW	65.6	65.9	66.3	66.6	66.8	67.9	68.1	68.4	68.6	68.8
	BF	0.01	0.03	0.05	0.06	0.08	0.00	0.01	0.04	0.06	0.08
50	TC	464	494	514	528	539	485	515	536	550	562
	SHC	-60	-44	-25	-4	19	-129	-123	-114	-104	-93
	kW	65.3	65.8	66.3	66.7	67.0	67.7	68.1	68.5	68.9	69.1
	BF	0.01	0.03	0.05	0.06	0.08	0.00	0.01	0.04	0.06	0.08
40	TC	479	510	531	546	557	500	532	553	568	580
	SHC	-47	-29	-8	14	38	-114	-107	-97	-85	-73
	kW	62.2	62.8	63.3	63.8	64.1	64.6	65.1	65.5	65.9	66.2
	BF	0.01	0.03	0.05	0.06	0.08	0.00	0.01	0.04	0.06	0.08

LEGEND

- BF** — Bypass Factor
- Edb** — Entering Dry Bulb
- Ewb** — Entering Wet Bulb
- kW** — Compressor Motor Power Input
- RH** — Relative Humidity
- SHC** — Sensible Heat Cap. (1000 Btu/h)
- TC** — Total Cap. (1000 Btu/h) Gross

6. SHC values provided reflect maximum reheat values with 100% gas bypass. Negative SHC value indicates that the air entering the coil is being heated at 100% gas bypass. The P Series innovative modulating valve system will reduce the gas bypass as required to meet the supply air setpoint with minimal change in latent capacity. The space will NOT be overheated and the unit will provide variable SHC to meet the space load.

NOTES:

1. The SHC is based on 75 F edb temperature of air entering evaporator coil. For edb temperatures other than 75 F, adjust SHC by multiplying the correction factor and the cfm and then adding or subtracting the value from the SHC.
2. Interpolation is permissible.
3. Correction Factor = $1.10 \times (1 - BF) \times (edb - 75)$.
4. Cooling capacities are gross and do not include deduction for indoor fan motor heat.
5. Capacity table includes impact of outdoor fan staging at temperatures below 75 F.

COOLING CAPACITIES (cont)

48/50P2,P3,P4,P5100 (100 TON) STANDARD CAPACITY COIL — STANDARD MODE

Temp (F) Air Entering Condenser (Edb)		Evaporator Air Quantity — Cfm														
		20,000					25,000					30,000				
		Evaporator Air — Ewb (F)														
		75	72	67	62	57	75	72	67	62	57	75	72	67	62	57
75	TC	1198	1147	1057	970	883	1251	1194	1104	1017	944	1285	1228	1138	1050	991
	SHC	489	549	663	768	854	509	593	727	856	928	535	632	786	935	991
	kW	68.6	67.4	65.6	64.1	62.7	69.9	68.5	66.6	65.0	63.7	70.8	69.3	67.4	65.7	64.7
	BF	0.00	0.00	0.14	0.11	0.13	0.00	0.23	0.14	0.12	0.22	0.12	0.19	0.15	0.14	0.28
85	TC	1161	1111	1023	938	855	1209	1155	1068	982	923	1238	1186	1099	1012	975
	SHC	475	536	648	752	833	490	579	711	840	892	521	617	771	917	947
	kW	75.7	74.6	72.9	71.5	70.2	77.0	75.7	73.9	72.4	71.2	77.8	76.5	74.6	73.0	72.2
	BF	0.00	0.10	0.14	0.10	0.14	0.00	0.20	0.14	0.12	0.27	0.10	0.18	0.15	0.14	0.35
95	TC	1121	1071	985	902	825	1164	1113	1027	942	893	1191	1141	1056	970	933
	SHC	457	522	632	735	811	480	564	695	821	870	506	602	754	896	933
	kW	84.1	83.0	81.4	80.0	79.3	85.2	84.1	82.4	80.8	79.7	86.0	84.8	83.1	81.5	80.8
	BF	0.00	0.08	0.13	0.10	0.15	0.14	0.18	0.13	0.12	0.28	0.28	0.17	0.14	0.14	0.33
105	TC	1077	1026	942	861	796	1113	1064	981	899	849	1139	1090	1007	924	897
	SHC	436	506	613	716	775	464	547	676	800	848	490	585	735	872	897
	kW	93.7	92.7	91.4	90.5	89.8	94.7	93.7	92.1	91.3	90.9	95.4	94.3	92.7	91.9	91.4
	BF	0.00	0.07	0.12	0.10	0.20	0.10	0.17	0.13	0.12	0.27	0.23	0.16	0.14	0.15	0.36
115	TC	1025	976	895	817	759	1057	1010	930	851	812	1080	1034	954	875	858
	SHC	417	487	593	695	747	447	528	656	778	812	471	565	715	841	858
	kW	104.6	103.9	103.4	103.4	103.1	105.4	104.6	103.9	103.9	103.8	106.1	105.3	104.3	104.1	104.0
	BF	0.00	0.18	0.11	0.09	0.21	0.08	0.15	0.12	0.12	0.30	0.20	0.16	0.14	0.17	0.39

48/50P2,P3,P4,P5100 (100 TON) STANDARD CAPACITY COIL — STANDARD MODE (cont)

Temp (F) Air Entering Condenser (Edb)		Evaporator Air Quantity — Cfm									
		35,000					40,000				
		Evaporator Air — Ewb (F)									
		75	72	67	62	57	75	72	67	62	57
75	TC	1310	1252	1162	1073	1038	1329	1273	1181	1092	1074
	SHC	561	669	843	1005	1038	584	705	898	1059	1074
	kW	71.4	70.0	68.0	66.2	65.5	71.9	70.5	68.4	66.6	66.2
	BF	0.27	0.19	0.16	0.17	0.36	0.24	0.19	0.17	0.21	0.42
85	TC	1260	1206	1121	1034	1007	1278	1224	1139	1054	1044
	SHC	545	654	828	980	1007	568	688	882	1032	1044
	kW	78.4	77.1	75.2	73.5	72.9	78.9	77.5	75.6	73.9	73.6
	BF	0.25	0.18	0.16	0.18	0.38	0.23	0.18	0.17	0.22	0.44
95	TC	1212	1160	1077	992	973	1228	1177	1093	1014	1006
	SHC	530	638	810	951	973	553	671	865	992	1006
	kW	86.6	85.3	83.6	81.9	81.5	87.0	85.8	84.0	82.3	82.2
	BF	0.23	0.17	0.16	0.19	0.40	0.22	0.18	0.17	0.25	0.46
105	TC	1158	1108	1026	947	937	1173	1123	1041	970	967
	SHC	513	620	791	926	937	536	653	845	960	967
	kW	95.9	94.8	93.2	92.2	91.7	96.4	95.3	93.6	92.5	92.4
	BF	0.21	0.17	0.15	0.20	0.43	0.21	0.18	0.17	0.27	0.48
115	TC	1098	1050	972	901	894	1110	1063	985	923	922
	SHC	495	600	770	882	894	517	633	824	923	922
	kW	106.6	105.7	104.7	104.0	104.2	107.0	106.1	104.9	104.4	104.5
	BF	0.19	0.16	0.15	0.24	0.45	0.20	0.17	0.17	0.29	0.51

LEGEND

48/50P3,P5 units only.

BF — Bypass Factor **kW** — Compressor Motor Power Input
Edb — Entering Dry Bulb **SHC** — Sensible Heat Cap. (1000 Btuh)
Ewb — Entering Wet Bulb **TC** — Total Cap. (1000 Btuh) Gross

NOTES:

- Direct interpolation is permissible. Do not extrapolate.
- The following formulas may be used:

$$t_{db} = t_{edb} - \frac{\text{sensible capacity (Btuh)}}{1.10 \times \text{cfm}}$$

t_{wb} = Wet-bulb temperature corresponding to enthalpy of air leaving evaporator coil (h_{wb}).

$$h_{wb} = h_{ewb} - \frac{\text{total capacity (Btuh)}}{4.5 \times \text{cfm}}$$

Where: h_{ewb} = Enthalpy of air entering evaporator coil.

- SHC is based on 80 F edb temperature of air entering evaporator coil.
Below 80 F edb, subtract (corr factor x cfm) from SHC.
Above 80 F edb, add (corr factor x cfm) to SHC.

BF	ENTERING AIR DRY-BULB TEMP (F)					
	79	78	77	76	75	under 75
	81	82	83	84	85	over 85
Correction Factor						
.05	1.04	2.09	3.14	4.18	5.22	Use formula shown below
.10	0.99	1.98	2.97	3.96	4.95	
.20	0.88	1.76	2.64	3.52	4.40	

Interpolation is permissible.
Correction Factor = $1.10 \times (1 - BF) \times (edb - 80)$.

- Cooling capacities are gross and do not include deduction for indoor fan motor heat.

Performance data (cont)



COOLING CAPACITIES (cont)

48/50P2,P3,P4,P5100 (100 TON) STANDARD CAPACITY COIL — SUBCOOL MODE

Temp (F) Air Entering Condenser (Edb)		Evaporator Air Quantity — Cfm														
		20,000					25,000					30,000				
		Evaporator Air — Ewb (F)														
		75	72	67	62	57	75	72	67	62	57	75	72	67	62	57
75	TC	1146	1084	987	897	815	1203	1165	1042	949	873	1261	1167	1071	986	932
	SHC	418	481	581	680	773	450	548	645	764	850	494	547	693	841	932
	kW	67.9	66.6	64.7	63.1	61.7	69.1	68.7	65.9	64.1	62.5	70.6	68.5	66.5	64.8	63.9
	BF	0.00	0.07	0.10	0.11	0.12	0.05	0.11	0.13	0.13	0.21	0.10	0.14	0.15	0.16	0.27
85	TC	1064	1005	946	856	779	1111	1053	991	913	836	1141	1089	1003	939	892
	SHC	351	414	551	648	735	373	450	607	739	814	390	484	638	805	892
	kW	74.1	72.8	71.6	70.1	68.7	75.2	73.9	72.5	71.1	69.5	76.0	74.8	73.0	71.5	70.8
	BF	0.00	0.07	0.10	0.11	0.15	0.05	0.11	0.13	0.13	0.22	0.10	0.14	0.15	0.16	0.29
95	TC	1004	941	894	813	762	1042	995	906	857	814	1073	1024	945	889	850
	SHC	306	365	511	614	719	321	408	535	695	793	340	437	596	767	850
	kW	81.6	80.2	79.5	78.3	77.8	82.6	81.5	79.6	78.9	78.4	83.4	82.3	80.5	79.5	79.0
	BF	0.00	0.07	0.10	0.11	0.16	0.06	0.11	0.13	0.14	0.23	0.10	0.14	0.15	0.17	0.30
105	TC	931	898	843	766	724	976	926	846	807	771	1003	955	866	836	805
	SHC	251	337	474	579	683	274	356	490	658	753	291	387	533	727	805
	kW	90.0	89.4	88.9	87.8	87.5	91.1	90.0	88.7	88.3	88.0	91.8	90.7	89.0	88.8	88.5
	BF	0.01	0.07	0.10	0.11	0.18	0.06	0.11	0.13	0.14	0.25	0.11	0.14	0.15	0.17	0.32
115	TC	867	835	792	715	683	905	859	797	762	726	927	882	823	779	756
	SHC	206	292	439	543	644	225	309	460	628	710	238	335	508	686	756
	kW	100.2	99.7	99.9	98.8	98.7	100.9	100.1	99.5	99.5	99.0	101.4	100.6	99.7	99.5	99.4
	BF	0.01	0.07	0.10	0.11	0.19	0.06	0.11	0.13	0.14	0.26	0.11	0.14	0.15	0.18	0.34

48/50P2,P3,P4,P5100 (100 TON) STANDARD CAPACITY COIL — SUBCOOL MODE (cont)

Temp (F) Air Entering Condenser (Edb)		Evaporator Air Quantity — Cfm									
		35,000					40,000				
		Evaporator Air — Ewb (F)									
		75	72	67	62	57	75	72	67	62	57
75	TC	1273	1210	1133	1020	973	1296	1233	1157	1036	998
	SHC	499	597	781	915	973	522	630	834	968	998
	kW	70.8	69.4	68.1	65.5	64.6	71.4	70.0	68.7	65.9	65.0
	BF	0.13	0.16	0.17	0.19	0.35	0.16	0.18	0.19	0.22	0.41
85	TC	1164	1107	1024	969	917	1186	1130	1043	967	964
	SHC	408	510	685	875	917	429	543	734	906	964
	kW	76.6	75.3	73.4	72.2	71.0	77.2	75.8	74.0	72.3	72.1
	BF	0.14	0.16	0.17	0.19	0.36	0.16	0.18	0.19	0.23	0.42
95	TC	1096	1044	961	914	886	1114	1059	979	935	876
	SHC	359	465	638	829	886	377	490	687	875	876
	kW	84.0	82.8	80.9	79.9	79.5	84.5	83.2	81.4	80.3	79.0
	BF	0.14	0.16	0.17	0.20	0.38	0.16	0.18	0.19	0.25	0.43
105	TC	1021	974	900	860	838	1037	990	918	886	825
	SHC	306	415	595	782	838	322	442	644	828	825
	kW	92.4	91.2	89.7	89.1	88.9	92.8	91.7	90.1	89.6	88.2
	BF	0.14	0.16	0.17	0.22	0.39	0.16	0.18	0.19	0.27	0.45
115	TC	944	901	833	806	787	824	955	913	841	813
	SHC	252	363	547	729	787	765	265	388	586	813
	kW	101.8	100.9	99.9	99.8	99.7	100.0	102.1	101.2	100.0	99.9
	BF	0.14	0.16	0.17	0.24	0.41	0.27	0.16	0.18	0.20	0.46

LEGEND

48/50P3,P5 units only.

BF — Bypass Factor **kW** — Compressor Motor Power Input
Edb — Entering Dry Bulb **SHC** — Sensible Heat Cap. (1000 Btu/h)
Ewb — Entering Wet Bulb **TC** — Total Cap. (1000 Btu/h) Gross

NOTES:

- The SHC is based on 80 F edb temperature of air entering evaporator coil. For edb temperatures other than 80 F, adjust SHC by multiplying the correction factor and the cfm and then adding or subtracting the value from the SHC.

- Interpolation is permissible.
- Correction Factor = $1.10 \times (1 - BF) \times (edb - 80)$.
- Cooling capacities are gross and do not include deduction for indoor fan motor heat.
- SHC values provided are in subcooling mode with the gas bypass valve closed and reflect the maximum SHC in subcooling mode. The P Series innovative modulating valve system can reduce SHC as needed to meet the supply air set point requirement with minimal change in latent capacity. This will provide variable SHC to meet the space load.

COOLING CAPACITIES (cont)

48/50P2,P3,P4,P5100 (100 TON) STANDARD CAPACITY COIL — HOT GAS REHEAT MODE

Temp (F) Air Ent Condenser (Edb)		Air Entering Evaporator — Ewb (F)									
		75 Dry Bulb 62.5 Wet Bulb (50% RH)					75 Dry Bulb 65.3 Wet Bulb (60% RH)				
		Air Entering Evaporator — Cfm									
		20,000	25,000	30,000	35,000	40,000	20,000	25,000	30,000	35,000	40,000
80	TC	348	374	393	406	417	370	398	417	431	453
	SHC	27	62	99	136	173	-51	-28	-3	21	60
	kW	71.6	71.3	71.1	71.1	71.1	73.3	72.8	72.7	72.8	71.9
	BF	0.10	0.13	0.15	0.17	0.19	0.09	0.12	0.15	0.17	0.19
75	TC	366	394	413	427	438	390	418	438	453	465
	SHC	42	78	115	153	190	-35	-11	15	42	70
	kW	68.5	68.2	68.2	68.2	68.2	70.2	69.9	69.9	70.1	70.2
	BF	0.10	0.13	0.15	0.17	0.19	0.09	0.12	0.15	0.17	0.19
70	TC	372	399	418	432	442	395	423	442	456	467
	SHC	47	82	120	157	195	-30	-7	20	47	75
	kW	68.5	68.4	68.4	68.6	68.8	70.3	70.2	70.5	70.8	71.0
	BF	0.10	0.13	0.15	0.17	0.19	0.09	0.12	0.15	0.17	0.19
60	TC	385	412	430	444	457	407	435	454	468	482
	SHC	57	94	132	170	200	-19	6	34	63	79
	kW	66.3	66.6	67.1	67.5	67.1	68.6	69.0	69.5	69.9	69.0
	BF	0.10	0.13	0.15	0.18	0.20	0.09	0.12	0.15	0.17	0.20
50	TC	434	460	478	491	501	458	484	503	516	526
	SHC	155	197	239	279	319	84	115	145	175	204
	kW	50.1	50.7	51.3	51.7	52.0	51.6	52.2	52.7	53.2	53.4
	BF	0.11	0.14	0.17	0.19	0.21	0.11	0.14	0.17	0.19	0.21
40	TC	449	478	495	509	519	473	502	520	534	545
	SHC	166	199	251	292	332	97	117	159	189	219
	kW	47.0	46.9	48.3	48.7	49.1	48.6	48.4	49.8	50.2	50.5
	BF	0.11	0.14	0.17	0.19	0.21	0.11	0.14	0.17	0.19	0.21

48/50P2,P3,P4,P5100 (100 TON) STANDARD CAPACITY COIL — HOT GAS REHEAT MODE (cont)

Temp (F) Air Ent Condenser (Edb)		Air Entering Evaporator — Ewb (F)									
		75 Dry Bulb 68 Wet Bulb (70% RH)					75 Dry Bulb 70.5 Wet Bulb (80% RH)				
		Air Entering Evaporator — Cfm									
		20,000	25,000	30,000	35,000	40,000	20,000	25,000	30,000	35,000	40,000
80	TC	393	422	442	456	479	415	445	477	492	504
	SHC	-127	-116	-104	-88	-56	-198	-195	-179	-172	-164
	kW	75.0	74.6	74.6	74.7	73.8	77.0	76.5	75.7	75.9	75.9
	BF	0.07	0.11	0.14	0.16	0.18	0.00	0.05	0.10	0.14	0.16
75	TC	413	443	464	479	491	436	466	488	503	516
	SHC	-109	-96	-81	-64	-46	-178	-174	-169	-161	-152
	kW	72.0	71.8	72.1	72.2	72.3	74.1	74.1	74.2	74.4	74.4
	BF	0.07	0.11	0.14	0.16	0.18	0.00	0.05	0.10	0.14	0.16
70	TC	417	446	466	481	492	439	469	489	504	515
	SHC	-103	-91	-75	-58	-40	-172	-169	-162	-155	-144
	kW	72.4	72.5	72.8	73.1	73.2	74.8	74.9	75.1	75.3	75.4
	BF	0.07	0.11	0.14	0.16	0.18	0.00	0.05	0.10	0.14	0.16
60	TC	429	457	477	495	507	450	479	503	518	530
	SHC	-91	-76	-58	-53	-37	-158	-152	-158	-151	-143
	kW	71.2	71.6	72.0	70.9	71.0	73.7	74.0	72.6	72.8	72.9
	BF	0.07	0.11	0.14	0.16	0.19	0.00	0.06	0.08	0.12	0.15
50	TC	481	508	527	540	551	504	530	550	564	574
	SHC	17	35	55	75	95	-47	-37	-28	-17	-5
	kW	53.1	53.7	54.2	54.6	54.8	54.6	55.2	55.6	56.0	56.2
	BF	0.08	0.13	0.16	0.19	0.21	0.03	0.08	0.13	0.16	0.19
40	TC	496	527	544	559	570	519	550	568	583	594
	SHC	30	37	69	90	110	-34	-37	-13	-1	10
	kW	50.1	49.9	51.3	51.7	51.9	51.6	51.3	52.6	53.0	53.2
	BF	0.08	0.12	0.16	0.19	0.21	0.03	0.07	0.13	0.16	0.19

LEGEND

- | | |
|--|--|
| BF — Bypass Factor | RH — Relative Humidity |
| Edb — Entering Dry Bulb | SHC — Sensible Heat Cap. (1000 Btu/h) |
| Ewb — Entering Wet Bulb | TC — Total Cap. (1000 Btu/h) Gross |
| kW — Compressor Motor Power Input | |

NOTES:

1. The SHC is based on 75 F edb temperature of air entering evaporator coil. For edb temperatures other than 75 F, adjust SHC by multiplying the correction factor and the cfm and then adding or subtracting the value from the SHC.
2. Interpolation is permissible.

3. Correction Factor = 1.10 x (1 - BF) x (edb - 75).
4. Cooling capacities are gross and do not include deduction for indoor fan motor heat.
5. Capacity table includes impact of outdoor fan staging at temperatures below 75 F.
6. SHC values provided reflect maximum reheat values with 100% gas bypass. Negative SHC value indicates that the air entering the coil is being heated at 100% gas bypass. The P Series innovative modulating valve system will reduce the gas bypass as required to meet the supply air setpoint with minimal change in latent capacity. The space will NOT be overheated and the unit will provide variable SHC to meet the space load.

Performance data (cont)



COOLING CAPACITIES (cont)

48/50P2,P3,P4,P5100 (100 TON) HIGH-CAPACITY COIL — STANDARD MODE

Temp (F) Air Entering Condenser (Edb)		Evaporator Air Quantity — Cfm														
		20,000					25,000					30,000				
		Evaporator Air — Ewb (F)														
		75	72	67	62	57	75	72	67	62	57	75	72	67	62	57
75	TC	1269	1208	1114	1026	941	1332	1267	1171	1081	1010	1373	1308	1210	1118	1069
	SHC	524	591	707	820	910	552	640	782	920	1002	585	685	852	1010	1069
	kW	71.2	69.7	67.3	65.4	63.7	72.9	71.1	68.7	66.6	65.0	73.9	72.2	69.7	67.5	66.4
	BF	0.00	0.05	0.05	0.03	0.06	0.10	0.08	0.05	0.04	0.15	0.14	0.08	0.06	0.06	0.24
85	TC	1231	1172	1084	998	916	1285	1227	1136	1048	987	1324	1265	1173	1083	1043
	SHC	505	577	694	805	891	537	626	767	904	977	568	670	836	993	1043
	kW	78.3	76.7	74.6	72.8	71.1	79.7	78.3	75.9	74.1	72.5	80.8	79.2	76.9	74.9	73.8
	BF	0.00	0.11	0.05	0.03	0.07	0.07	0.07	0.05	0.04	0.17	0.12	0.07	0.05	0.06	0.25
95	TC	1189	1136	1049	963	887	1241	1183	1097	1010	955	1275	1221	1131	1041	1012
	SHC	488	563	678	788	871	522	609	751	885	955	552	653	819	971	1012
	kW	86.5	85.1	83.2	81.5	80.1	88.0	86.5	84.5	82.7	81.3	89.0	87.6	85.5	83.4	82.5
	BF	0.00	0.10	0.04	0.03	0.08	0.06	0.07	0.05	0.04	0.18	0.10	0.07	0.05	0.06	0.28
105	TC	1147	1090	1007	923	853	1193	1139	1051	965	921	1224	1170	1082	995	975
	SHC	473	545	659	768	849	506	592	731	863	921	535	635	800	945	975
	kW	96.1	94.7	93.3	92.4	90.6	97.6	96.3	94.6	93.4	92.2	98.6	97.3	95.5	94.0	93.0
	BF	0.00	0.07	0.04	0.03	0.09	0.13	0.07	0.04	0.04	0.21	0.09	0.07	0.05	0.07	0.30
115	TC	1095	1043	959	877	817	1137	1085	999	915	883	1166	1113	1027	945	933
	SHC	455	526	638	746	816	487	572	710	839	883	516	614	778	912	933
	kW	107.2	106.4	105.6	105.4	104.0	108.8	107.9	106.7	106.4	104.6	109.9	108.8	107.6	106.5	105.5
	BF	0.08	0.07	0.04	0.03	0.12	0.10	0.06	0.04	0.05	0.24	0.08	0.06	0.05	0.09	0.33

48/50P2,P3,P4,P5100 (100 TON) HIGH-CAPACITY COIL — STANDARD MODE (cont)

Temp (F) Air Entering Condenser (Edb)		Evaporator Air Quantity — Cfm									
		35,000					40,000				
		Evaporator Air — Ewb (F)									
		75	72	67	62	57	75	72	67	62	57
75	TC	1402	1337	1239	1144	1118	1426	1360	1260	1170	1159
	SHC	613	729	919	1086	1118	640	769	984	1149	1159
	kW	74.7	73.0	70.4	68.2	67.6	75.3	73.6	71.0	68.8	68.6
	BF	0.11	0.07	0.06	0.09	0.31	0.10	0.08	0.07	0.13	0.38
85	TC	1351	1292	1199	1107	1090	1373	1313	1219	1135	1128
	SHC	596	712	903	1064	1090	623	753	967	1121	1128
	kW	81.6	80.0	77.6	75.5	74.9	82.2	80.6	78.2	76.1	75.9
	BF	0.10	0.08	0.06	0.09	0.33	0.10	0.08	0.07	0.15	0.40
95	TC	1302	1246	1155	1069	1057	1322	1264	1173	1097	1093
	SHC	580	695	886	1038	1057	606	736	949	1083	1093
	kW	89.8	88.3	86.2	84.1	83.7	90.4	88.9	86.8	84.7	84.6
	BF	0.09	0.07	0.06	0.11	0.35	0.09	0.08	0.07	0.18	0.41
105	TC	1249	1192	1104	1026	1018	1266	1209	1120	1054	1052
	SHC	562	677	865	1004	1018	588	717	928	1048	1052
	kW	99.4	98.0	96.2	94.4	94.0	100.0	98.6	96.8	94.6	94.7
	BF	0.09	0.07	0.06	0.13	0.38	0.09	0.08	0.07	0.20	0.44
115	TC	1187	1133	1046	976	973	1204	1149	1061	1009	1006
	SHC	542	656	842	971	973	568	696	904	999	1006
	kW	110.6	109.5	108.3	105.9	106.2	111.5	110.2	108.6	106.8	106.9
	BF	0.08	0.07	0.06	0.15	0.40	0.09	0.07	0.07	0.24	0.46

LEGEND

48/50P3,P5 units only.

BF — Bypass Factor **kW** — Compressor Motor Power Input
Edb — Entering Dry Bulb **SHC** — Sensible Heat Cap. (1000 Btuh)
Ewb — Entering Wet Bulb **TC** — Total Cap. (1000 Btuh) Gross

NOTES:

- Direct interpolation is permissible. Do not extrapolate.
- The following formulas may be used:

$$t_{db} = t_{edb} - \frac{\text{sensible capacity (Btuh)}}{1.10 \times \text{cfm}}$$

t_{wb} = Wet-bulb temperature corresponding to enthalpy of air leaving evaporator coil (h_{wb}).

$$h_{wb} = h_{ewb} - \frac{\text{total capacity (Btuh)}}{4.5 \times \text{cfm}}$$

Where: h_{ewb} = Enthalpy of air entering evaporator coil.

- SHC is based on 80 F edb temperature of air entering evaporator coil.
 Below 80 F edb, subtract (corr factor x cfm) from SHC.
 Above 80 F edb, add (corr factor x cfm) to SHC.

BF	ENTERING AIR DRY-BULB TEMP (F)					
	79	78	77	76	75	under 75
	81	82	83	84	85	over 85
Correction Factor						
.05	1.04	2.09	3.14	4.18	5.22	Use formula shown below
.10	0.99	1.98	2.97	3.96	4.95	
.20	0.88	1.76	2.64	3.52	4.40	

Interpolation is permissible.
 Correction Factor = $1.10 \times (1 - \text{BF}) \times (\text{edb} - 80)$.

- Cooling capacities are gross and do not include deduction for indoor fan motor heat.

COOLING CAPACITIES (cont)

48/50P2,P3,P4,P5100 (100 TON) HIGH-CAPACITY COIL — SUBCOOL MODE

Temp (F) Air Entering Condenser (Edb)		Evaporator Air Quantity — Cfm														
		20,000					25,000					30,000				
		Evaporator Air — Ewb (F)														
		75	72	67	62	57	75	72	67	62	57	75	72	67	62	57
75	TC	1210	1148	1077	994	900	1255	1205	1119	1042	951	1306	1243	1145	1080	1025
	SHC	417	489	633	756	848	433	531	687	843	924	470	571	738	929	1025
	kW	69.7	68.3	66.8	65.4	64.1	70.8	69.6	67.7	66.2	64.1	72.1	70.6	68.4	67.0	66.0
	BF	0.00	0.01	0.03	0.03	0.06	0.01	0.04	0.04	0.05	0.13	0.04	0.05	0.06	0.07	0.19
85	TC	1152	1116	1016	942	863	1204	1140	1077	993	933	1274	1213	1136	1029	981
	SHC	374	471	584	714	811	398	482	658	806	907	461	560	745	889	981
	kW	76.4	75.5	73.3	72.6	71.7	77.7	76.2	74.8	73.2	72.4	79.0	77.6	76.2	73.8	73.1
	BF	0.00	0.01	0.03	0.03	0.08	0.01	0.04	0.04	0.05	0.14	0.04	0.06	0.06	0.07	0.21
95	TC	1091	1035	965	876	825	1139	1083	1017	926	890	1171	1110	1026	975	935
	SHC	329	405	546	659	774	350	441	614	752	866	370	471	650	848	935
	kW	84.2	82.9	81.9	80.7	80.9	85.4	84.1	82.8	81.3	81.3	86.3	84.8	82.9	82.3	81.8
	BF	0.00	0.01	0.03	0.03	0.09	0.01	0.04	0.04	0.05	0.15	0.04	0.05	0.06	0.07	0.22
105	TC	1027	1000	909	824	758	1068	1013	957	888	844	1097	1041	924	919	885
	SHC	283	387	505	621	709	300	390	571	728	823	318	422	567	805	885
	kW	93.4	93.2	92.0	91.3	90.3	94.3	93.2	92.7	92.2	91.8	95.0	93.8	91.7	92.4	92.2
	BF	0.00	0.01	0.03	0.03	0.11	0.02	0.04	0.04	0.05	0.17	0.05	0.05	0.06	0.08	0.24
115	TC	960	935	849	789	715	987	929	892	811	794	1010	971	893	844	810
	SHC	237	342	476	602	669	242	327	541	668	775	255	374	556	736	810
	kW	104.3	104.5	103.8	104.7	102.8	104.7	103.8	104.2	103.5	104.2	105.2	104.6	103.7	103.3	103.1
	BF	0.01	0.02	0.03	0.03	0.13	0.02	0.04	0.05	0.06	0.19	0.05	0.05	0.06	0.10	0.26

48/50P2,P3,P4,P5100 (100 TON) HIGH-CAPACITY COIL — SUBCOOL MODE (cont)

Temp (F) Air Entering Condenser (Edb)		Evaporator Air Quantity — Cfm									
		35,000					40,000				
		Evaporator Air — Ewb (F)									
		75	72	67	62	57	75	72	67	62	57
75	TC	1334	1272	1173	1099	1046	1356	1293	1220	1135	1114
	SHC	494	609	800	996	1046	517	646	885	1072	1114
	kW	72.9	71.4	69.1	67.3	66.2	73.6	72.0	69.8	68.2	67.7
	BF	0.06	0.07	0.07	0.09	0.28	0.08	0.08	0.09	0.13	0.35
85	TC	1302	1263	1111	1056	1018	1323	1262	1129	1078	1051
	SHC	487	621	753	962	1018	510	636	809	1010	1051
	kW	79.7	79.1	75.7	74.4	73.5	80.3	78.9	76.2	74.9	74.2
	BF	0.06	0.07	0.07	0.10	0.29	0.08	0.09	0.09	0.14	0.36
95	TC	1194	1138	1049	991	978	1208	1147	1067	1014	1012
	SHC	391	510	708	904	978	407	535	765	949	1012
	kW	87.0	85.6	83.5	82.3	82.3	87.5	85.9	83.9	82.6	82.8
	BF	0.06	0.07	0.07	0.11	0.30	0.08	0.09	0.09	0.15	0.37
105	TC	1117	1058	976	935	925	1133	1080	995	972	957
	SHC	337	451	654	850	925	355	490	711	915	957
	kW	95.6	94.2	92.7	92.2	92.4	96.1	94.7	93.0	92.9	92.7
	BF	0.07	0.07	0.07	0.13	0.32	0.08	0.09	0.09	0.18	0.38
115	TC	1037	980	902	889	869	1050	994	911	896	898
	SHC	281	396	602	808	869	298	428	649	837	898
	kW	105.8	104.7	103.6	104.2	104.1	106.2	105.0	103.7	103.8	104.1
	BF	0.07	0.07	0.08	0.15	0.34	0.08	0.09	0.09	0.19	0.40

LEGEND

48/50P3,P5 units only.

BF — Bypass Factor **kW** — Compressor Motor Power Input
Edb — Entering Dry Bulb **SHC** — Sensible Heat Cap. (1000 Btu/h)
Ewb — Entering Wet Bulb **TC** — Total Cap. (1000 Btu/h) Gross

NOTES:

- The SHC is based on 80 F edb temperature of air entering evaporator coil. For edb temperatures other than 80 F, adjust SHC by multiplying the correction factor and the cfm and then adding or subtracting the value from the SHC.

- Interpolation is permissible.
- Correction Factor = $1.10 \times (1 - BF) \times (edb - 80)$.
- Cooling capacities are gross and do not include deduction for indoor fan motor heat.
- SHC values provided are in subcooling mode with the gas bypass valve closed and reflect the maximum SHC in subcooling mode. The P Series innovative modulating valve system can reduce SHC as needed to meet the supply air set point requirement with minimal change in latent capacity. This will provide variable SHC to meet the space load.

Performance data (cont)



COOLING CAPACITIES (cont)

48/50P2,P3,P4,P5100 (100 TON) HIGH-CAPACITY COIL — HOT GAS REHEAT MODE

Temp (F) Air Ent Condenser (Edb)		Air Entering Evaporator — Ewb (F)									
		75 Dry Bulb 62.5 Wet Bulb (50% RH)					75 Dry Bulb 65.3 Wet Bulb (60% RH)				
		Air Entering Evaporator — Cfm									
		20,000	25,000	30,000	35,000	40,000	20,000	25,000	30,000	35,000	40,000
80	TC	384	412	432	446	457	408	437	457	472	483
	SHC	36	76	120	166	210	-49	-23	7	37	73
	kW	73.1	72.5	72.4	72.3	72.3	74.9	74.4	74.2	74.4	74.4
	BF	0.03	0.05	0.06	0.08	0.09	0.03	0.04	0.06	0.07	0.09
75	TC	394	423	443	457	469	418	448	469	483	494
	SHC	43	84	128	173	219	-42	-15	15	48	82
	kW	70.6	70.2	70.2	70.4	70.5	72.5	72.2	72.4	72.7	72.8
	BF	0.03	0.05	0.06	0.07	0.09	0.03	0.04	0.06	0.07	0.09
70	TC	399	427	446	460	471	422	451	471	485	495
	SHC	46	87	131	177	222	-39	-12	16	51	84
	kW	70.7	70.5	70.7	71.0	71.2	72.8	72.8	73.1	73.5	73.7
	BF	0.03	0.05	0.06	0.07	0.09	0.03	0.04	0.06	0.07	0.09
60	TC	412	439	458	471	481	434	462	481	494	505
	SHC	57	97	142	188	234	-29	-2	29	62	99
	kW	68.6	69.0	69.5	70.0	70.2	71.2	71.6	72.1	72.5	72.8
	BF	0.03	0.05	0.06	0.07	0.09	0.03	0.04	0.06	0.07	0.09
50	TC	419	445	463	475	485	440	467	485	498	507
	SHC	63	105	149	197	244	-22	5	38	72	110
	kW	68.0	68.7	69.4	69.9	70.2	70.8	71.5	72.1	72.6	72.9
	BF	0.03	0.05	0.06	0.07	0.09	0.03	0.04	0.06	0.07	0.09
40	TC	433	460	478	491	501	455	482	501	514	525
	SHC	75	118	164	213	261	-9	21	55	91	129
	kW	64.9	65.8	66.5	67.1	67.4	67.8	68.6	69.2	69.8	70.1
	BF	0.03	0.05	0.06	0.07	0.09	0.03	0.04	0.06	0.07	0.09

48/50P2,P3,P4,P5100 (100 TON) HIGH-CAPACITY COIL — HOT GAS REHEAT MODE (cont)

Temp (F) Air Ent Condenser (Edb)		Air Entering Evaporator — Ewb (F)									
		75 Dry Bulb 68 Wet Bulb (70% RH)					75 Dry Bulb 70.5 Wet Bulb (80% RH)				
		Air Entering Evaporator — Cfm									
		20,000	25,000	30,000	35,000	40,000	20,000	25,000	30,000	35,000	40,000
80	TC	432	462	483	498	509	455	486	507	522	534
	SHC	-132	-120	-105	-86	-61	-211	-210	-208	-201	-185
	kW	76.9	76.4	76.5	76.7	76.7	79.1	78.7	78.8	78.9	79.0
	BF	0.01	0.04	0.06	0.07	0.09	0.00	0.01	0.04	0.07	0.09
75	TC	442	473	494	509	521	465	497	519	534	546
	SHC	-126	-111	-93	-73	-51	-202	-201	-196	-188	-174
	kW	74.7	74.6	74.8	75.0	75.1	77.1	77.0	77.1	77.3	77.4
	BF	0.01	0.04	0.06	0.07	0.09	0.00	0.02	0.05	0.07	0.09
70	TC	446	475	495	509	520	467	497	518	532	544
	SHC	-122	-108	-93	-71	-49	-199	-200	-196	-183	-172
	kW	75.3	75.4	75.6	76.0	76.1	77.8	77.8	78.0	78.3	78.3
	BF	0.01	0.04	0.06	0.07	0.09	0.00	0.02	0.05	0.07	0.09
60	TC	456	485	504	518	528	477	507	526	540	551
	SHC	-110	-98	-80	-58	-35	-189	-187	-180	-169	-157
	kW	74.0	74.3	74.7	75.1	75.3	76.7	76.9	77.3	77.6	77.7
	BF	0.02	0.04	0.06	0.07	0.09	0.00	0.02	0.05	0.07	0.09
50	TC	461	488	507	520	530	481	509	528	541	552
	SHC	-104	-89	-69	-47	-23	-181	-177	-169	-158	-145
	kW	73.7	74.3	74.9	75.3	75.6	76.6	77.1	77.5	77.9	78.1
	BF	0.02	0.04	0.06	0.07	0.09	0.00	0.02	0.05	0.07	0.09
40	TC	476	504	524	537	548	497	526	545	559	570
	SHC	-90	-72	-51	-27	-2	-165	-158	-148	-136	-122
	kW	70.7	71.4	72.0	72.5	72.8	73.6	74.2	74.7	75.1	75.3
	BF	0.02	0.04	0.06	0.07	0.09	0.00	0.02	0.05	0.07	0.09

LEGEND

BF — Bypass Factor
Edb — Entering Dry Bulb
Ewb — Entering Wet Bulb
kW — Compressor Motor Power Input
RH — Relative Humidity
SHC — Sensible Heat Cap. (1000 Btu/h)
TC — Total Cap. (1000 Btu/h) Gross

6. SHC values provided reflect maximum reheat values with 100% gas bypass. Negative SHC value indicates that the air entering the coil is being heated at 100% gas bypass. The P Series innovative modulating valve system will reduce the gas bypass as required to meet the supply air setpoint with minimal change in latent capacity. The space will NOT be overheated and the unit will provide variable SHC to meet the space load.

NOTES:

- The SHC is based on 75 F edb temperature of air entering evaporator coil. For edb temperatures other than 75 F, adjust SHC by multiplying the correction factor and the cfm and then adding or subtracting the value from the SHC.
- Interpolation is permissible.
- Correction Factor = $1.10 \times (1 - BF) \times (edb - 75)$.
- Cooling capacities are gross and do not include deduction for indoor fan motor heat.
- Capacity table includes impact of outdoor fan staging at temperatures below 75 F.



FAN PERFORMANCE — 48P2,P3,P4,P5030 AND 50P2,P3030 UNITS WITHOUT DISCHARGE PLENUM*

AIRFLOW (cfm)	AVAILABLE EXTERNAL STATIC PRESSURE (in. wg)															
	0.2		0.4		0.6		0.8		1.0		1.2		1.4		1.6	
	Rpm	Bhp	Rpm	Bhp	Rpm	Bhp	Rpm	Bhp	Rpm	Bhp	Rpm	Bhp	Rpm	Bhp	Rpm	Bhp
6,000	222	0.59	284	0.91	339	1.27	388	1.66	430	2.07	469	2.50	504	2.93	536	3.38
7,500	248	0.94	300	1.28	350	1.68	395	2.11	437	2.57	475	3.05	511	3.54	544	4.05
9,000	278	1.46	323	1.80	366	2.22	407	2.69	446	3.19	483	3.71	517	4.25	550	4.81
10,500	311	2.16	349	2.52	387	2.95	424	3.43	459	3.96	493	4.51	526	5.10	558	5.70
12,000	344	3.08	378	3.44	412	3.89	445	4.39	477	4.93	508	5.51	539	6.12	569	6.75
13,500	379	4.25	410	4.62	440	5.07	469	5.58	498	6.13	527	6.73	555	7.36	583	8.02
15,000	415	5.69	442	6.06	470	6.52	496	7.04	523	7.61	549	8.22	575	8.87	601	9.55

AIRFLOW (cfm)	AVAILABLE EXTERNAL STATIC PRESSURE (in. wg)															
	1.8		2.0		2.2		2.4		2.6		2.8		3.0		3.2	
	Rpm	Bhp	Rpm	Bhp	Rpm	Bhp	Rpm	Bhp	Rpm	Bhp	Rpm	Bhp	Rpm	Bhp	Rpm	Bhp
6,000	567	3.84	595	4.30	622	4.78	647	5.26	671	5.75	695	6.25	717	6.76	738	7.27
7,500	575	4.57	604	5.10	632	5.63	658	6.18	683	6.73	707	7.29	730	7.86	752	8.43
9,000	581	5.38	611	5.97	639	6.56	665	7.16	691	7.78	715	8.40	739	9.03	761	9.66
10,500	588	6.31	617	6.95	645	7.59	672	8.25	697	8.92	722	9.59	746	10.28	769	10.97
12,000	598	7.41	625	8.08	652	8.77	679	9.47	704	10.19	728	10.91	752	11.65	775	12.39
13,500	610	8.71	637	9.41	662	10.14	687	10.88	712	11.63	736	12.40	759	13.18	782	13.98
15,000	626	10.25	651	10.98	675	11.74	699	12.51	723	13.30	746	14.10	768	14.92	790	15.75

AIRFLOW (cfm)	AVAILABLE EXTERNAL STATIC PRESSURE (in. wg)							
	3.4		3.6		3.8		4.0	
	Rpm	Bhp	Rpm	Bhp	Rpm	Bhp	Rpm	Bhp
6,000	759	7.79	779	8.32	799	8.85	817	9.39
7,500	773	9.01	794	9.60	814	10.20	833	10.80
9,000	783	10.30	805	10.95	825	11.60	845	12.26
10,500	791	11.67	812	12.38	833	13.09	854	13.81
12,000	797	13.15	819	13.91	840	14.68	860	15.45
13,500	804	14.77	825	15.59	846	16.41	867	17.23
15,000	812	16.59	833	17.45	853	18.31	874	19.19

LEGEND

48/50P3,P5 units only.

Bhp — Brake Horsepower

*If calculating static pressure for a 48 Series unit, be sure to add gas heat pressure drop from Component Pressure Drop table.

NOTES:

1. Fan performance is based on wet coils and clean 2-in. filters.

2. See Component Pressure Drop data table before using Fan Performance tables.

3. Conversion — Bhp to kW:

$$\text{Kilowatts} = \frac{\text{Bhp} \times .746}{\text{Motor efficiency}}$$

See Physical Data table for motor efficiency.

Performance data (cont)



FAN PERFORMANCE — 48P2,P3,P4,P5035 AND 50P2,P3035 UNITS WITHOUT DISCHARGE PLENUM*

AIRFLOW (cfm)	AVAILABLE EXTERNAL STATIC PRESSURE (in. wg)															
	0.2		0.4		0.6		0.8		1.0		1.2		1.4		1.6	
	Rpm	Bhp	Rpm	Bhp	Rpm	Bhp	Rpm	Bhp	Rpm	Bhp	Rpm	Bhp	Rpm	Bhp	Rpm	Bhp
7,000	246	0.84	301	1.19	352	1.58	398	2.01	440	2.46	479	2.93	514	3.40	547	3.90
8,000	266	1.14	315	1.50	362	1.92	406	2.37	447	2.85	484	3.35	519	3.87	552	4.39
10,000	310	1.98	350	2.36	389	2.80	427	3.30	464	3.83	499	4.38	532	4.96	564	5.55
12,000	357	3.20	390	3.60	424	4.06	457	4.58	489	5.15	520	5.74	551	6.36	580	7.01
14,000	406	4.87	435	5.28	463	5.76	492	6.30	520	6.89	548	7.52	576	8.18	603	8.86
15,000	430	5.89	458	6.31	485	6.80	511	7.35	538	7.95	564	8.59	590	9.26	616	9.96

AIRFLOW (cfm)	AVAILABLE EXTERNAL STATIC PRESSURE (in. wg)															
	1.8		2.0		2.2		2.4		2.6		2.8		3.0		3.2	
	Rpm	Bhp	Rpm	Bhp	Rpm	Bhp	Rpm	Bhp	Rpm	Bhp	Rpm	Bhp	Rpm	Bhp	Rpm	Bhp
7,000	577	4.40	606	4.91	633	5.43	659	5.95	684	6.49	707	7.03	730	7.58	752	8.14
8,000	583	4.94	612	5.49	640	6.05	666	6.62	691	7.19	715	7.78	738	8.37	760	8.97
10,000	594	6.16	623	6.79	651	7.42	677	8.07	703	8.73	727	9.39	751	10.06	774	10.74
12,000	609	7.67	636	8.36	663	9.05	689	9.77	714	10.49	738	11.22	762	11.97	785	12.72
14,000	629	9.57	655	10.30	680	11.04	704	11.81	728	12.59	751	13.38	774	14.18	796	14.99
15,000	641	10.69	666	11.44	690	12.20	714	12.99	737	13.79	760	14.61	782	15.44	804	16.28

AIRFLOW (cfm)	AVAILABLE EXTERNAL STATIC PRESSURE (in. wg)							
	3.4		3.6		3.8		4.0	
	Rpm	Bhp	Rpm	Bhp	Rpm	Bhp	Rpm	Bhp
7,000	773	8.70	793	9.27	813	9.85	832	10.43
8,000	782	9.57	802	10.18	823	10.80	842	11.43
10,000	796	11.42	817	12.11	838	12.81	858	13.52
12,000	807	13.48	828	14.25	849	15.02	869	15.80
14,000	818	15.82	840	16.66	860	17.50	880	18.35
15,000	825	17.13	846	18.00	866	18.87	886	19.76

LEGEND

48/50P3,P5 units only.

Bhp — Brake Horsepower

*If calculating static pressure for a 48 Series unit, be sure to add gas heat pressure drop from Component Pressure Drop table.

NOTES:

1. Fan performance is based on wet coils and clean 2-in. filters.

2. See Component Pressure Drop data table before using Fan Performance tables.
3. Conversion — Bhp to kW:

$$\text{Kilowatts} = \frac{\text{Bhp} \times .746}{\text{Motor efficiency}}$$

See Physical Data table for motor efficiency.

FAN PERFORMANCE — 48P2,P3,P4,P5040 AND 50P2,P3040 UNITS WITHOUT DISCHARGE PLENUM*

AIRFLOW (cfm)	AVAILABLE EXTERNAL STATIC PRESSURE (in. wg)															
	0.2		0.4		0.6		0.8		1.0		1.2		1.4		1.6	
	Rpm	Bhp	Rpm	Bhp	Rpm	Bhp	Rpm	Bhp	Rpm	Bhp	Rpm	Bhp	Rpm	Bhp	Rpm	Bhp
8,000	252	0.98	303	1.33	350	1.72	394	2.14	434	2.58	472	3.06	507	3.55	540	4.07
10,000	290	1.67	333	2.11	373	2.55	412	3.01	448	3.51	483	4.03	517	4.58	549	5.16
12,000	330	2.65	369	3.18	404	3.70	438	4.23	470	4.78	501	5.35	532	5.94	562	6.56
14,000	372	3.96	407	4.61	439	5.22	469	5.83	498	6.44	526	7.07	554	7.72	581	8.38
16,000	415	5.67	447	6.44	476	7.15	504	7.85	530	8.54	556	9.24	581	9.95	605	10.67
18,000	459	7.84	488	8.72	515	9.55	541	10.34	565	11.12	589	11.91	612	12.69	634	13.47
20,000	503	10.51	530	11.51	555	12.46	579	13.36	602	14.24	624	15.11	645	15.98	666	16.84

AIRFLOW (cfm)	AVAILABLE EXTERNAL STATIC PRESSURE (in. wg)															
	1.8		2.0		2.2		2.4		2.6		2.8		3.0		3.2	
	Rpm	Bhp	Rpm	Bhp	Rpm	Bhp	Rpm	Bhp	Rpm	Bhp	Rpm	Bhp	Rpm	Bhp	Rpm	Bhp
8,000	571	4.60	600	5.14	628	5.70	654	6.27	679	6.85	703	7.44	726	8.04	748	8.65
10,000	579	5.75	608	6.36	636	6.98	662	7.62	688	8.28	712	8.94	736	9.62	758	10.30
12,000	590	7.21	618	7.87	645	8.55	671	9.25	696	9.96	720	10.69	744	11.43	766	12.19
14,000	607	9.07	633	9.78	658	10.51	683	11.25	707	12.02	730	12.80	753	13.60	775	14.41
16,000	629	11.41	653	12.16	676	12.94	699	13.73	722	14.54	744	15.37	766	16.22	787	17.08
18,000	656	14.28	678	15.09	700	15.91	721	16.76	742	17.62	762	18.49	783	19.39	803	20.29
20,000	687	17.71	707	18.60	727	19.48	747	20.38	766	21.30	785	22.22	804	23.17	—	—

AIRFLOW (cfm)	AVAILABLE EXTERNAL STATIC PRESSURE (in. wg)							
	3.4		3.6		3.8		4.0	
	Rpm	Bhp	Rpm	Bhp	Rpm	Bhp	Rpm	Bhp
8,000	770	9.27	791	9.90	811	10.54	830	11.18
10,000	780	11.00	802	11.71	822	12.43	842	13.15
12,000	789	12.96	810	13.73	831	14.52	851	15.32
14,000	797	15.24	818	16.07	839	16.93	859	17.79
16,000	808	17.95	828	18.85	849	19.75	868	20.67
18,000	823	21.21	842	22.15	862	23.11	—	—
20,000	—	—	—	—	—	—	—	—

LEGEND

 48/50P3,P5 units only.

Bhp — Brake Horsepower

*If calculating static pressure for a 48 Series unit, be sure to add gas heat pressure drop from Component Pressure Drop table.

NOTES:

1. Fan performance is based on wet coils and clean 2-in. filters.

2. See Component Pressure Drop data table before using Fan Performance tables.

3. Conversion — Bhp to kW:

$$\text{Kilowatts} = \frac{\text{Bhp} \times .746}{\text{Motor efficiency}}$$

See Physical Data table for motor efficiency.

Performance data (cont)



FAN PERFORMANCE — 48P2,P3,P4,P5050 AND 50P2,P3050 UNITS WITHOUT DISCHARGE PLENUM*

AIRFLOW (cfm)	AVAILABLE EXTERNAL STATIC PRESSURE (in. wg)															
	0.2		0.4		0.6		0.8		1.0		1.2		1.4		1.6	
	Rpm	Bhp	Rpm	Bhp	Rpm	Bhp	Rpm	Bhp	Rpm	Bhp	Rpm	Bhp	Rpm	Bhp	Rpm	Bhp
9,000	276	1.34	323	1.73	366	2.15	407	2.60	445	3.08	482	3.58	516	4.11	549	4.66
10,000	296	1.74	339	2.17	379	2.62	418	3.09	454	3.59	489	4.12	522	4.68	554	5.26
12,000	339	2.76	376	3.29	411	3.81	445	4.35	477	4.91	509	5.49	539	6.09	568	6.71
14,000	382	4.15	416	4.79	448	5.40	478	6.01	506	6.63	535	7.26	562	7.92	589	8.60
16,000	427	5.96	458	6.71	487	7.42	514	8.11	540	8.81	565	9.52	590	10.23	615	10.97
18,000	473	8.26	501	9.12	527	9.93	552	10.72	576	11.50	600	12.29	623	13.08	645	13.88
20,000	519	11.10	545	12.06	570	12.99	593	13.88	615	14.76	637	15.63	658	16.50	679	17.38

AIRFLOW (cfm)	AVAILABLE EXTERNAL STATIC PRESSURE (in. wg)															
	1.8		2.0		2.2		2.4		2.6		2.8		3.0		3.2	
	Rpm	Bhp	Rpm	Bhp	Rpm	Bhp	Rpm	Bhp	Rpm	Bhp	Rpm	Bhp	Rpm	Bhp	Rpm	Bhp
9,000	579	5.23	608	5.81	636	6.41	662	7.02	687	7.64	712	8.27	735	8.91	757	9.57
10,000	584	5.85	613	6.47	641	7.10	667	7.74	692	8.40	717	9.07	740	9.75	763	10.44
12,000	597	7.36	625	8.03	651	8.72	677	9.42	702	10.14	726	10.88	750	11.63	772	12.39
14,000	615	9.29	641	10.01	666	10.74	690	11.50	714	12.27	738	13.06	760	13.87	783	14.69
16,000	639	11.71	663	12.48	686	13.27	709	14.07	731	14.89	753	15.73	775	16.58	796	17.45
18,000	667	14.69	689	15.51	711	16.35	732	17.20	753	18.07	773	18.96	793	19.86	813	20.78
20,000	699	18.25	719	19.14	739	20.04	759	20.95	778	21.88	797	22.82	816	23.77	—	—

AIRFLOW (cfm)	AVAILABLE EXTERNAL STATIC PRESSURE (in. wg)							
	3.4		3.6		3.8		4.0	
	Rpm	Bhp	Rpm	Bhp	Rpm	Bhp	Rpm	Bhp
9,000	779	10.23	800	10.90	821	11.58	840	12.27
10,000	785	11.14	806	11.85	826	12.57	846	13.30
12,000	794	13.16	816	13.94	836	14.73	857	15.54
14,000	804	15.52	825	16.37	846	17.22	866	18.10
16,000	817	18.34	837	19.24	857	20.15	877	21.08
18,000	833	21.71	853	22.66	872	23.62	—	—
20,000	—	—	—	—	—	—	—	—

LEGEND

48/50P3,P5 units only.

Bhp — Brake Horsepower

*If calculating static pressure for a 48 Series unit, be sure to add gas heat pressure drop from Component Pressure Drop table.

NOTES:

1. Fan performance is based on wet coils and clean 2-in. filters.

2. See Component Pressure Drop data table before using Fan Performance tables.

3. Conversion — Bhp to kW:

$$\text{Kilowatts} = \frac{\text{Bhp} \times .746}{\text{Motor efficiency}}$$

See Physical Data table for motor efficiency.

FAN PERFORMANCE — 48P2,P3,P4,P5055 AND 50P2,P3055 UNITS WITHOUT DISCHARGE PLENUM*

AIRFLOW (cfm)	AVAILABLE EXTERNAL STATIC PRESSURE (in. wg)															
	0.2		0.4		0.6		0.8		1.0		1.2		1.4		1.6	
	Rpm	Bhp	Rpm	Bhp	Rpm	Bhp	Rpm	Bhp	Rpm	Bhp	Rpm	Bhp	Rpm	Bhp	Rpm	Bhp
10,000	207	1.04	253	1.50	295	2.03	334	2.66	371	3.41	405	4.26	438	5.20	468	6.20
12,500	235	1.69	276	2.23	312	2.78	346	3.40	379	4.10	410	4.88	440	5.75	469	6.70
15,000	265	2.59	302	3.23	335	3.85	365	4.51	394	5.20	422	5.96	449	6.78	476	7.67
17,500	295	3.78	331	4.52	361	5.24	389	5.97	415	6.71	440	7.48	465	8.30	489	9.17
20,000	327	5.31	360	6.15	388	6.98	414	7.79	439	8.60	462	9.43	485	10.28	507	11.17
22,500	359	7.23	390	8.16	417	9.09	442	10.00	465	10.90	487	11.81	508	12.72	528	13.65
25,000	392	9.59	421	10.60	447	11.62	470	12.64	492	13.64	513	14.63	533	15.62	552	16.62

AIRFLOW (cfm)	AVAILABLE EXTERNAL STATIC PRESSURE (in. wg)															
	1.8		2.0		2.2		2.4		2.6		2.8		3.0		3.2	
	Rpm	Bhp	Rpm	Bhp	Rpm	Bhp	Rpm	Bhp	Rpm	Bhp	Rpm	Bhp	Rpm	Bhp	Rpm	Bhp
10,000	497	7.27	523	8.39	549	9.55	573	10.75	596	11.98	618	13.23	639	14.51	659	15.81
12,500	497	7.73	523	8.83	549	10.00	573	11.22	597	12.49	619	13.81	641	15.16	662	16.55
15,000	501	8.63	526	9.67	550	10.77	574	11.94	597	13.17	619	14.46	641	15.80	662	17.19
17,500	512	10.09	535	11.07	557	12.11	579	13.21	601	14.38	622	15.60	643	16.88	663	18.21
20,000	528	12.09	549	13.06	570	14.07	590	15.12	610	16.24	630	17.40	649	18.62	668	19.89
22,500	548	14.60	567	15.59	587	16.61	605	17.66	624	18.75	642	19.88	660	21.06	678	22.28
25,000	571	17.63	589	18.66	607	19.71	624	20.78	642	21.89	659	23.02	676	24.19	692	25.39

AIRFLOW (cfm)	AVAILABLE EXTERNAL STATIC PRESSURE (in. wg)							
	3.4		3.6		3.8		4.0	
	Rpm	Bhp	Rpm	Bhp	Rpm	Bhp	Rpm	Bhp
10,000	679	17.13	697	18.46	715	19.81	733	21.17
12,500	682	17.98	702	19.43	721	20.90	739	22.40
15,000	682	18.63	702	20.10	721	21.62	740	23.17
17,500	683	19.60	702	21.04	721	22.53	740	24.06
20,000	687	21.20	706	22.57	724	24.00	742	25.46
22,500	696	23.55	713	24.86	731	26.22	748	27.62
25,000	709	26.62	725	27.91	741	29.22	—	—

LEGEND

48/50P3,P5 units only.

Bhp — Brake Horsepower

*If calculating static pressure for a 48 Series unit, be sure to add gas heat pressure drop from Component Pressure Drop table.

NOTES:

1. Fan performance is based on wet coils and clean 2-in. filters.

2. See Component Pressure Drop data table before using Fan Performance tables.

3. Conversion — Bhp to kW:

$$\text{Kilowatts} = \frac{\text{Bhp} \times .746}{\text{Motor efficiency}}$$

See Physical Data table for motor efficiency.

Performance data (cont)



FAN PERFORMANCE — 48P2,P3,P4,P5060 AND 50P2,P3060 UNITS WITHOUT DISCHARGE PLENUM*

AIRFLOW (cfm)	AVAILABLE EXTERNAL STATIC PRESSURE (in. wg)															
	0.2		0.4		0.6		0.8		1.0		1.2		1.4		1.6	
	Rpm	Bhp	Rpm	Bhp	Rpm	Bhp	Rpm	Bhp	Rpm	Bhp	Rpm	Bhp	Rpm	Bhp	Rpm	Bhp
12,000	234	1.54	276	2.03	312	2.57	348	3.20	382	3.93	415	4.74	446	5.63	476	6.58
15,000	271	2.65	309	3.27	341	3.88	370	4.53	399	5.24	428	6.04	455	6.91	482	7.85
18,000	308	4.22	344	5.00	374	5.73	400	6.46	426	7.22	450	8.02	474	8.88	498	9.81
21,000	348	6.36	380	7.29	408	8.18	434	9.04	457	9.88	479	10.74	501	11.64	522	12.58
24,000	390	9.19	417	10.24	444	11.29	469	12.29	491	13.27	512	14.23	532	15.21	551	16.20
27,000	433	12.80	456	13.93	481	15.14	504	16.30	526	17.44	546	18.53	565	19.62	583	20.71
30,000	476	17.29	497	18.50	519	19.82	541	21.15	562	22.45	581	23.70	599	24.93	617	26.14

AIRFLOW (cfm)	AVAILABLE EXTERNAL STATIC PRESSURE (in. wg)															
	1.8		2.0		2.2		2.4		2.6		2.8		3.0		3.2	
	Rpm	Bhp	Rpm	Bhp	Rpm	Bhp	Rpm	Bhp	Rpm	Bhp	Rpm	Bhp	Rpm	Bhp	Rpm	Bhp
12,000	504	7.56	530	8.57	555	9.61	578	10.66	600	11.73	621	12.81	641	13.91	660	15.01
15,000	509	8.87	535	9.95	559	11.07	583	12.25	606	13.45	628	14.68	650	15.95	670	17.23
18,000	521	10.79	544	11.85	567	12.97	590	14.14	612	15.38	633	16.66	654	17.99	675	19.36
21,000	543	13.56	563	14.60	583	15.69	603	16.84	623	18.05	643	19.31	662	20.63	682	21.99
24,000	570	17.22	588	18.28	607	19.39	625	20.53	642	21.72	660	22.95	678	24.24	695	25.58
27,000	601	21.81	618	22.93	635	24.07	651	25.25	667	26.46	684	27.70	700	28.98	715	30.31
30,000	634	27.34	650	28.56	666	29.78	681	31.02	696	32.28	711	33.56	726	34.88	—	—

AIRFLOW (cfm)	AVAILABLE EXTERNAL STATIC PRESSURE (in. wg)							
	3.4		3.6		3.8		4.0	
	Rpm	Bhp	Rpm	Bhp	Rpm	Bhp	Rpm	Bhp
12,000	679	16.11	697	17.23	714	18.35	730	19.49
15,000	690	18.52	709	19.84	727	21.15	745	22.49
18,000	695	20.76	714	22.20	733	23.66	—	—
21,000	701	23.41	719	24.87	738	26.38	—	—
24,000	713	26.97	730	28.40	747	29.89	—	—
27,000	731	31.67	747	33.08	—	—	—	—
30,000	—	—	—	—	—	—	—	—

LEGEND

48/50P3,P5 units only.

Bhp — Brake Horsepower

*If calculating static pressure for a 48 Series unit, be sure to add gas heat pressure drop from Component Pressure Drop table.

NOTES:

1. Fan performance is based on wet coils and clean 2-in. filters.

2. See Component Pressure Drop data table before using Fan Performance tables.

3. Conversion — Bhp to kW:

$$\text{Kilowatts} = \frac{\text{Bhp} \times .746}{\text{Motor efficiency}}$$

See Physical Data table for motor efficiency.

FAN PERFORMANCE — 48P2,P3,P4,P5070 AND 50P2,P3070 UNITS WITHOUT DISCHARGE PLENUM*

AIRFLOW (cfm)	AVAILABLE EXTERNAL STATIC PRESSURE (in. wg)															
	0.2		0.4		0.6		0.8		1.0		1.2		1.4		1.6	
	Rpm	Bhp	Rpm	Bhp	Rpm	Bhp	Rpm	Bhp	Rpm	Bhp	Rpm	Bhp	Rpm	Bhp	Rpm	Bhp
14,000	258	2.23	297	2.80	330	3.38	362	4.02	392	4.73	422	5.53	451	6.42	480	7.37
17,500	302	3.92	338	4.67	368	5.39	395	6.10	421	6.84	446	7.64	471	8.50	495	9.42
21,000	348	6.36	380	7.29	408	8.18	434	9.04	457	9.88	479	10.74	501	11.64	522	12.57
24,500	397	9.74	424	10.80	450	11.88	475	12.91	497	13.91	517	14.89	537	15.88	556	16.89
28,000	447	14.18	470	15.35	494	16.60	516	17.82	538	19.01	558	20.16	576	21.29	594	22.41
30,000	476	17.29	497	18.50	519	19.82	541	21.15	562	22.45	581	23.70	599	24.93	617	26.14

AIRFLOW (cfm)	AVAILABLE EXTERNAL STATIC PRESSURE (in. wg)															
	1.8		2.0		2.2		2.4		2.6		2.8		3.0		3.2	
	Rpm	Bhp	Rpm	Bhp	Rpm	Bhp	Rpm	Bhp	Rpm	Bhp	Rpm	Bhp	Rpm	Bhp	Rpm	Bhp
14,000	507	8.39	533	9.46	558	10.57	582	11.71	605	12.89	627	14.08	648	15.29	668	16.52
17,500	519	10.42	542	11.48	565	12.60	588	13.78	610	15.02	632	16.30	653	17.62	674	18.99
21,000	543	13.56	563	14.60	583	15.69	603	16.84	623	18.05	643	19.31	662	20.63	682	21.99
24,500	575	17.93	593	18.99	611	20.10	629	21.24	646	22.43	664	23.67	681	24.96	698	26.29
28,000	612	23.55	628	24.69	645	25.86	661	27.05	677	28.27	692	29.53	708	30.82	723	32.15
30,000	634	27.34	650	28.56	666	29.78	681	31.02	696	32.28	711	33.56	726	34.88	—	—

AIRFLOW (cfm)	AVAILABLE EXTERNAL STATIC PRESSURE (in. wg)							
	3.4		3.6		3.8		4.0	
	Rpm	Bhp	Rpm	Bhp	Rpm	Bhp	Rpm	Bhp
14,000	687	17.76	706	19.01	724	20.27	741	21.54
17,500	694	20.38	713	21.79	732	23.24	—	—
21,000	701	23.41	719	24.87	738	26.38	—	—
24,500	715	27.67	732	29.10	749	30.58	—	—
28,000	739	33.51	—	—	—	—	—	—
30,000	—	—	—	—	—	—	—	—

LEGEND

48/50P3,P5 units only.

Bhp — Brake Horsepower

*If calculating static pressure for a 48 Series unit, be sure to add gas heat pressure drop from Component Pressure Drop table.

NOTES:

1. Fan performance is based on wet coils and clean 2-in. filters.

2. See Component Pressure Drop data table before using Fan Performance tables.

3. Conversion — Bhp to kW:

$$\text{Kilowatts} = \frac{\text{Bhp} \times .746}{\text{Motor efficiency}}$$

See Physical Data table for motor efficiency.

Performance data (cont)



FAN PERFORMANCE — 50P2,P3030 UNITS WITH DISCHARGE PLENUM AND 50P4,P5030 UNITS

AIRFLOW (cfm)	AVAILABLE EXTERNAL STATIC PRESSURE (in. wg)															
	0.2		0.4		0.6		0.8		1.0		1.2		1.4		1.6	
	Rpm	Bhp	Rpm	Bhp	Rpm	Bhp	Rpm	Bhp	Rpm	Bhp	Rpm	Bhp	Rpm	Bhp	Rpm	Bhp
6,000	255	0.95	313	1.35	364	1.82	411	2.35	454	2.92	494	3.52	530	4.14	563	4.78
7,500	291	1.51	340	1.93	386	2.41	428	2.94	468	3.51	505	4.13	541	4.78	574	5.46
9,000	330	2.28	372	2.73	413	3.22	451	3.76	487	4.34	522	4.96	555	5.61	587	6.30
10,500	371	3.28	408	3.76	444	4.28	479	4.84	512	5.43	544	6.06	574	6.71	604	7.40
12,000	413	4.56	447	5.07	479	5.61	510	6.19	540	6.80	570	7.44	598	8.11	626	8.80
13,500	456	6.12	487	6.66	516	7.23	544	7.83	572	8.46	599	9.12	626	9.81	651	10.51
15,000	500	7.99	528	8.58	555	9.18	581	9.80	606	10.45	631	11.13	656	11.83	680	12.56

AIRFLOW (cfm)	AVAILABLE EXTERNAL STATIC PRESSURE (in. wg)															
	1.8		2.0		2.2		2.4		2.6		2.8		3.0		3.2	
	Rpm	Bhp	Rpm	Bhp	Rpm	Bhp	Rpm	Bhp	Rpm	Bhp	Rpm	Bhp	Rpm	Bhp	Rpm	Bhp
6,000	594	5.43	623	6.09	651	6.75	676	7.41	701	8.08	725	8.75	747	9.42	769	10.10
7,500	605	6.16	635	6.88	664	7.62	691	8.36	716	9.11	741	9.88	765	10.64	787	11.41
9,000	617	7.02	646	7.76	674	8.52	702	9.31	728	10.11	753	10.93	777	11.76	800	12.60
10,500	633	8.12	660	8.86	687	9.64	713	10.43	739	11.25	764	12.09	788	12.95	811	13.82
12,000	652	9.52	679	10.27	704	11.04	729	11.84	753	12.66	777	13.50	800	14.37	823	15.26
13,500	676	11.25	701	12.00	725	12.78	748	13.58	771	14.40	794	15.24	816	16.11	838	16.99
15,000	703	13.30	726	14.07	749	14.86	771	15.66	793	16.49	814	17.34	835	18.20	856	19.09

AIRFLOW (cfm)	AVAILABLE EXTERNAL STATIC PRESSURE (in. wg)							
	3.4		3.6		3.8		4.0	
	Rpm	Bhp	Rpm	Bhp	Rpm	Bhp	Rpm	Bhp
6,000	789	10.77	809	11.45	829	12.13	848	12.81
7,500	809	12.18	830	12.96	851	13.73	870	14.51
9,000	823	13.44	844	14.29	866	15.15	886	16.01
10,500	833	14.71	856	15.61	877	16.52	898	17.44
12,000	845	16.16	867	17.08	888	18.01	—	—
13,500	859	17.90	880	18.82	—	—	—	—
15,000	876	20.00	896	20.92	—	—	—	—

LEGEND

50P3,P5 units only.
Bhp — Brake Horsepower

NOTES:

1. Fan performance is based on wet coils and clean 2-in. filters.

2. See Component Pressure Drop data table before using Fan Performance tables.
3. Conversion — Bhp to kW:

$$\text{Kilowatts} = \frac{\text{Bhp} \times .746}{\text{Motor efficiency}}$$

See Physical Data Table for motor efficiency.

FAN PERFORMANCE — 50P2,P3035 UNITS WITH DISCHARGE PLENUM AND 50P4,P5035 UNITS

AIRFLOW (cfm)	AVAILABLE EXTERNAL STATIC PRESSURE (in. wg)															
	0.2		0.4		0.6		0.8		1.0		1.2		1.4		1.6	
	Rpm	Bhp	Rpm	Bhp	Rpm	Bhp	Rpm	Bhp	Rpm	Bhp	Rpm	Bhp	Rpm	Bhp	Rpm	Bhp
7,000	285	1.35	337	1.78	384	2.26	428	2.80	469	3.38	507	4.00	542	4.66	576	5.34
8,000	311	1.81	358	2.25	402	2.75	442	3.29	481	3.87	517	4.50	551	5.16	584	5.86
10,000	367	3.04	406	3.52	443	4.05	479	4.61	512	5.21	545	5.84	576	6.51	606	7.21
12,000	426	4.74	459	5.26	491	5.82	522	6.42	552	7.05	581	7.70	609	8.38	637	9.09
14,000	486	6.98	515	7.55	543	8.15	570	8.78	597	9.44	623	10.12	649	10.83	674	11.55
15,000	517	8.33	544	8.92	570	9.54	596	10.18	621	10.85	646	11.55	671	12.27	694	13.01

AIRFLOW (cfm)	AVAILABLE EXTERNAL STATIC PRESSURE (in. wg)															
	1.8		2.0		2.2		2.4		2.6		2.8		3.0		3.2	
	Rpm	Bhp	Rpm	Bhp	Rpm	Bhp	Rpm	Bhp	Rpm	Bhp	Rpm	Bhp	Rpm	Bhp	Rpm	Bhp
7,000	607	6.03	637	6.74	665	7.46	691	8.18	717	8.91	741	9.65	764	10.39	786	11.13
8,000	615	6.58	645	7.32	673	8.07	700	8.84	726	9.62	751	10.41	775	11.20	797	12.00
10,000	636	7.94	664	8.70	691	9.48	717	10.29	743	11.11	768	11.96	792	12.82	815	13.69
12,000	663	9.83	689	10.59	715	11.38	739	12.19	764	13.03	787	13.88	810	14.76	833	15.66
14,000	698	12.31	722	13.08	745	13.88	768	14.69	791	15.53	813	16.39	834	17.27	856	18.17
15,000	718	13.78	741	14.56	763	15.36	785	16.19	807	17.03	828	17.90	849	18.78	869	19.69

AIRFLOW (cfm)	AVAILABLE EXTERNAL STATIC PRESSURE (in. wg)							
	3.4		3.6		3.8		4.0	
	Rpm	Bhp	Rpm	Bhp	Rpm	Bhp	Rpm	Bhp
7,000	807	11.88	828	12.62	848	13.37	867	14.12
8,000	819	12.80	841	13.61	861	14.42	881	15.23
10,000	837	14.57	859	15.47	881	16.37	—	—
12,000	855	16.57	876	17.51	897	18.45	—	—
14,000	876	19.10	897	20.04	—	—	—	—
15,000	890	20.61	—	—	—	—	—	—

LEGEND

50P3,P5 units only.
Bhp — Brake Horsepower

NOTES:

1. Fan performance is based on wet coils and clean 2-in. filters.

2. See Component Pressure Drop data table before using Fan Performance tables.
3. Conversion — Bhp to kW:

$$\text{Kilowatts} = \frac{\text{Bhp} \times .746}{\text{Motor efficiency}}$$

See Physical Data table for motor efficiency.

Performance data (cont)



FAN PERFORMANCE — 50P2,P3040 UNITS WITH DISCHARGE PLENUM AND 50P4,P5040 UNITS

AIRFLOW (cfm)	AVAILABLE EXTERNAL STATIC PRESSURE (in. wg)															
	0.2		0.4		0.6		0.8		1.0		1.2		1.4		1.6	
	Rpm	Bhp	Rpm	Bhp	Rpm	Bhp	Rpm	Bhp	Rpm	Bhp	Rpm	Bhp	Rpm	Bhp	Rpm	Bhp
8,000	293	1.62	344	2.10	390	2.62	432	3.18	470	3.76	507	4.36	541	4.97	573	5.60
10,000	343	2.66	385	3.19	425	3.76	463	4.36	498	4.99	532	5.64	563	6.31	594	7.00
12,000	395	4.09	431	4.68	466	5.29	500	5.93	532	6.60	562	7.30	592	8.01	620	8.75
14,000	449	5.97	481	6.62	512	7.28	541	7.96	570	8.67	598	9.40	626	10.16	652	10.93
16,000	504	8.32	533	9.06	560	9.77	587	10.50	613	11.25	638	12.02	663	12.81	688	13.62
18,000	559	11.20	586	12.04	611	12.82	635	13.59	659	14.38	682	15.19	705	16.01	727	16.86
20,000	615	14.66	640	15.59	663	16.44	685	17.28	707	18.11	728	18.96	749	19.83	770	20.71

AIRFLOW (cfm)	AVAILABLE EXTERNAL STATIC PRESSURE (in. wg)															
	1.8		2.0		2.2		2.4		2.6		2.8		3.0		3.2	
	Rpm	Bhp	Rpm	Bhp	Rpm	Bhp	Rpm	Bhp	Rpm	Bhp	Rpm	Bhp	Rpm	Bhp	Rpm	Bhp
8,000	603	6.23	632	6.87	659	7.50	685	8.14	710	8.78	734	9.43	757	10.07	779	10.71
10,000	623	7.70	651	8.41	678	9.13	703	9.86	728	10.60	752	11.33	776	12.08	798	12.82
12,000	648	9.50	674	10.26	699	11.04	724	11.83	748	12.63	772	13.44	794	14.25	817	15.07
14,000	677	11.73	702	12.54	726	13.35	750	14.19	772	15.04	795	15.89	817	16.76	838	17.64
16,000	712	14.45	735	15.30	757	16.16	779	17.03	801	17.92	822	18.82	843	19.73	863	20.65
18,000	749	17.73	771	18.61	792	19.50	813	20.42	833	21.34	853	22.27	873	23.23	—	—
20,000	790	21.61	811	22.52	830	23.45	—	—	—	—	—	—	—	—	—	—

AIRFLOW (cfm)	AVAILABLE EXTERNAL STATIC PRESSURE (in. wg)							
	3.4		3.6		3.8		4.0	
	Rpm	Bhp	Rpm	Bhp	Rpm	Bhp	Rpm	Bhp
8,000	800	11.35	821	12.00	841	12.64	860	13.28
10,000	820	13.57	841	14.31	862	15.06	882	15.81
12,000	838	15.90	859	16.73	880	17.57	900	18.40
14,000	859	18.53	879	19.42	899	20.32	—	—
16,000	883	21.58	—	—	—	—	—	—
18,000	—	—	—	—	—	—	—	—
20,000	—	—	—	—	—	—	—	—

LEGEND

50P3,P5 units only.

Bhp — Brake Horsepower

NOTES:

1. Fan performance is based on wet coils and clean 2-in. filters.

2. See Component Pressure Drop data table before using Fan Performance tables.

3. Conversion — Bhp to kW:

$$\text{Kilowatts} = \frac{\text{Bhp} \times .746}{\text{Motor efficiency}}$$

See Physical Data table for motor efficiency.

FAN PERFORMANCE — 50P2,P3050 UNITS WITH DISCHARGE PLENUM AND 50P4,P5050 UNITS

AIRFLOW (cfm)	AVAILABLE EXTERNAL STATIC PRESSURE (in. wg)															
	0.2		0.4		0.6		0.8		1.0		1.2		1.4		1.6	
	Rpm	Bhp	Rpm	Bhp	Rpm	Bhp	Rpm	Bhp	Rpm	Bhp	Rpm	Bhp	Rpm	Bhp	Rpm	Bhp
9,000	324	2.15	369	2.67	412	3.23	452	3.83	488	4.44	523	5.08	556	5.73	587	6.40
10,000	349	2.74	392	3.28	431	3.87	469	4.48	504	5.12	537	5.78	569	6.46	599	7.16
12,000	403	4.23	439	4.82	474	5.45	507	6.11	539	6.80	570	7.51	599	8.23	627	8.98
14,000	459	6.17	490	6.83	521	7.50	550	8.20	579	8.93	607	9.69	634	10.46	660	11.25
16,000	515	8.63	544	9.34	571	10.07	597	10.82	623	11.59	649	12.38	674	13.20	698	14.03
18,000	573	11.65	599	12.44	623	13.21	647	14.00	671	14.82	694	15.65	716	16.50	739	17.37
20,000	630	15.28	654	16.14	677	16.97	699	17.81	720	18.66	741	19.53	762	20.43	783	21.34

AIRFLOW (cfm)	AVAILABLE EXTERNAL STATIC PRESSURE (in. wg)															
	1.8		2.0		2.2		2.4		2.6		2.8		3.0		3.2	
	Rpm	Bhp	Rpm	Bhp	Rpm	Bhp	Rpm	Bhp	Rpm	Bhp	Rpm	Bhp	Rpm	Bhp	Rpm	Bhp
9,000	617	7.08	645	7.77	672	8.47	698	9.18	723	9.90	747	10.62	770	11.34	793	12.07
10,000	628	7.87	656	8.59	682	9.33	708	10.07	733	10.82	757	11.58	780	12.35	802	13.12
12,000	654	9.74	680	10.51	706	11.30	730	12.10	754	12.90	778	13.73	800	14.56	822	15.39
14,000	686	12.06	710	12.88	734	13.71	757	14.55	780	15.41	802	16.27	824	17.15	845	18.04
16,000	721	14.88	744	15.74	767	16.62	789	17.51	810	18.41	831	19.32	852	20.24	872	21.17
18,000	761	18.27	782	19.17	803	20.09	824	21.02	844	21.96	864	22.92	884	23.88	—	—
20,000	803	22.27	823	23.21	—	—	—	—	—	—	—	—	—	—	—	—

AIRFLOW (cfm)	AVAILABLE EXTERNAL STATIC PRESSURE (in. wg)							
	3.4		3.6		3.8		4.0	
	Rpm	Bhp	Rpm	Bhp	Rpm	Bhp	Rpm	Bhp
9,000	814	12.79	835	13.52	855	14.25	875	14.99
10,000	824	13.89	845	14.67	866	15.45	886	16.23
12,000	844	16.24	865	17.09	885	17.95	—	—
14,000	866	18.94	886	19.85	—	—	—	—
16,000	892	22.12	—	—	—	—	—	—
18,000	—	—	—	—	—	—	—	—
20,000	—	—	—	—	—	—	—	—

LEGEND

 50P3,P5 units only.

Bhp — Brake Horsepower

NOTES:

1. Fan performance is based on wet coils and clean 2-in. filters.

2. See Component Pressure Drop data table before using Fan Performance tables.

3. Conversion — Bhp to kW:

$$\text{Kilowatts} = \frac{\text{Bhp} \times .746}{\text{Motor efficiency}}$$

See Physical Data table for motor efficiency.

Performance data (cont)



FAN PERFORMANCE — 50P2,P3055 UNITS WITH DISCHARGE PLENUM AND 50P4,P5055 UNITS

AIRFLOW (cfm)	AVAILABLE EXTERNAL STATIC PRESSURE (in. wg)															
	0.2		0.4		0.6		0.8		1.0		1.2		1.4		1.6	
	Rpm	Bhp	Rpm	Bhp	Rpm	Bhp	Rpm	Bhp	Rpm	Bhp	Rpm	Bhp	Rpm	Bhp	Rpm	Bhp
10,000	217	1.21	258	1.71	296	2.29	334	2.97	371	3.76	407	4.63	440	5.56	471	6.51
12,500	248	2.01	286	2.63	319	3.26	349	3.95	380	4.71	410	5.58	440	6.52	469	7.54
15,000	281	3.13	317	3.90	347	4.64	374	5.38	400	6.18	425	7.03	450	7.95	476	8.95
17,500	315	4.64	348	5.55	378	6.43	403	7.29	426	8.16	449	9.05	471	10.00	493	10.99
20,000	351	6.64	381	7.64	409	8.68	433	9.68	456	10.66	477	11.64	497	12.65	516	13.68
22,500	389	9.20	414	10.25	440	11.43	464	12.59	486	13.71	506	14.81	525	15.91	543	17.03
25,000	427	12.39	449	13.48	473	14.75	496	16.06	517	17.34	537	18.59	555	19.82	573	21.04

AIRFLOW (cfm)	AVAILABLE EXTERNAL STATIC PRESSURE (in. wg)															
	1.8		2.0		2.2		2.4		2.6		2.8		3.0		3.2	
	Rpm	Bhp	Rpm	Bhp	Rpm	Bhp	Rpm	Bhp	Rpm	Bhp	Rpm	Bhp	Rpm	Bhp	Rpm	Bhp
10,000	500	7.48	527	8.46	552	9.45	576	10.44	598	11.42	619	12.41	639	13.41	659	14.41
12,500	498	8.63	525	9.76	552	10.93	577	12.12	601	13.32	624	14.54	646	15.76	667	16.99
15,000	501	10.03	526	11.17	550	12.38	575	13.65	598	14.97	621	16.32	644	17.71	666	19.11
17,500	514	12.05	536	13.17	557	14.35	579	15.60	600	16.91	621	18.28	643	19.70	663	21.18
20,000	535	14.76	554	15.88	573	17.06	592	18.29	611	19.58	630	20.91	649	22.31	668	23.77
22,500	561	18.17	579	19.34	596	20.54	613	21.78	629	23.06	646	24.40	663	25.78	680	27.20
25,000	590	22.27	606	23.51	622	24.78	637	26.07	653	27.39	668	28.75	683	30.13	699	31.56

AIRFLOW (cfm)	AVAILABLE EXTERNAL STATIC PRESSURE (in. wg)							
	3.4		3.6		3.8		4.0	
	Rpm	Bhp	Rpm	Bhp	Rpm	Bhp	Rpm	Bhp
10,000	677	15.40	695	16.40	712	17.40	728	18.41
12,500	687	18.22	706	19.45	725	20.69	742	21.92
15,000	687	20.54	707	21.98	727	23.43	746	24.89
17,500	684	22.69	704	24.24	724	25.83	743	27.43
20,000	686	25.27	705	26.84	723	28.44	742	30.09
22,500	697	28.68	713	30.21	730	31.79	747	33.42
25,000	714	33.04	729	34.55	—	—	—	—

LEGEND

50P3,P5 units only.
Bhp — Brake Horsepower

NOTES:

1. Fan performance is based on wet coils and clean 2-in. filters.

2. See Component Pressure Drop data table before using Fan Performance tables.
3. Conversion — Bhp to kW:

$$\text{Kilowatts} = \frac{\text{Bhp} \times .746}{\text{Motor efficiency}}$$

See Physical Data table for motor efficiency.

FAN PERFORMANCE — 50P2,P3060 UNITS WITH DISCHARGE PLENUM AND 50P4,P5060 UNITS

AIRFLOW (cfm)	AVAILABLE EXTERNAL STATIC PRESSURE (in. wg)															
	0.2		0.4		0.6		0.8		1.0		1.2		1.4		1.6	
	Rpm	Bhp	Rpm	Bhp	Rpm	Bhp	Rpm	Bhp	Rpm	Bhp	Rpm	Bhp	Rpm	Bhp	Rpm	Bhp
12,000	241	1.82	280	2.41	314	3.04	346	3.72	376	4.47	405	5.26	433	6.11	460	7.01
15,000	281	3.14	316	3.87	346	4.61	374	5.38	400	6.19	426	7.05	450	7.95	474	8.90
18,000	323	5.03	355	5.92	382	6.80	408	7.68	431	8.58	454	9.53	476	10.50	498	11.52
21,000	366	7.61	395	8.66	421	9.69	444	10.71	466	11.73	487	12.78	507	13.85	527	14.94
24,000	410	10.97	437	12.20	460	13.39	482	14.55	503	15.71	523	16.88	541	18.07	560	19.27
27,000	455	15.23	479	16.65	501	18.00	522	19.33	542	20.64	560	21.95	578	23.26	595	24.58
30,000	500	20.52	522	22.11	543	23.64	563	25.14	581	26.61	599	28.06	616	29.52	632	30.97

AIRFLOW (cfm)	AVAILABLE EXTERNAL STATIC PRESSURE (in. wg)															
	1.8		2.0		2.2		2.4		2.6		2.8		3.0		3.2	
	Rpm	Bhp	Rpm	Bhp	Rpm	Bhp	Rpm	Bhp	Rpm	Bhp	Rpm	Bhp	Rpm	Bhp	Rpm	Bhp
12,000	486	7.94	511	8.91	535	9.91	559	10.94	581	11.99	603	13.07	624	14.16	645	15.28
15,000	498	9.90	520	10.93	543	12.01	564	13.11	586	14.26	606	15.43	627	16.63	646	17.86
18,000	518	12.57	539	13.66	559	14.78	579	15.95	598	17.15	617	18.39	636	19.65	654	20.95
21,000	546	16.07	564	17.23	583	18.42	600	19.64	618	20.90	635	22.19	653	23.51	669	24.86
24,000	577	20.49	594	21.74	611	23.00	628	24.31	644	25.63	660	26.99	676	28.38	691	29.77
27,000	611	25.91	628	27.26	643	28.63	659	30.03	674	31.44	689	32.87	703	34.33	718	35.82
30,000	648	32.43	663	33.90	678	35.38	—	—	—	—	—	—	—	—	—	—

AIRFLOW (cfm)	AVAILABLE EXTERNAL STATIC PRESSURE (in. wg)							
	3.4		3.6		3.8		4.0	
	Rpm	Bhp	Rpm	Bhp	Rpm	Bhp	Rpm	Bhp
12,000	664	16.40	683	17.55	702	18.70	720	19.87
15,000	666	19.12	685	20.39	703	21.69	721	23.01
18,000	672	22.28	690	23.64	708	25.02	725	26.44
21,000	686	26.25	703	27.67	719	29.11	735	30.59
24,000	707	31.23	722	32.71	737	34.20	—	—
27,000	—	—	—	—	—	—	—	—
30,000	—	—	—	—	—	—	—	—

LEGEND

 50P3,P5 units only.

Bhp — Brake Horsepower

NOTES:

1. Fan performance is based on wet coils and clean 2-in. filters.

2. See Component Pressure Drop data table before using Fan Performance tables.

3. Conversion — Bhp to kW:

$$\text{Kilowatts} = \frac{\text{Bhp} \times .746}{\text{Motor efficiency}}$$

See Physical Data table for motor efficiency.

Performance data (cont)



FAN PERFORMANCE — 50P2,P3070 UNITS WITH DISCHARGE PLENUM AND 50P4,P5070 UNITS

AIRFLOW (cfm)	AVAILABLE EXTERNAL STATIC PRESSURE (in. wg)															
	0.2		0.4		0.6		0.8		1.0		1.2		1.4		1.6	
	Rpm	Bhp	Rpm	Bhp	Rpm	Bhp	Rpm	Bhp	Rpm	Bhp	Rpm	Bhp	Rpm	Bhp	Rpm	Bhp
14,000	268	2.64	304	3.32	335	4.02	364	4.76	391	5.55	418	6.39	444	7.27	468	8.20
17,500	316	4.67	348	5.54	376	6.39	402	7.25	426	8.14	449	9.06	472	10.03	493	11.03
21,000	366	7.61	395	8.66	421	9.69	444	10.71	466	11.73	487	12.78	507	13.85	527	14.94
24,500	417	11.61	444	12.87	467	14.09	489	15.28	509	16.47	529	17.66	547	18.86	565	20.08
28,000	470	16.88	493	18.35	515	19.77	536	21.15	555	22.51	573	23.87	590	25.22	607	26.59
30,000	500	20.52	522	22.11	543	23.64	563	25.14	581	26.61	599	28.06	616	29.52	632	30.97

AIRFLOW (cfm)	AVAILABLE EXTERNAL STATIC PRESSURE (in. wg)															
	1.8		2.0		2.2		2.4		2.6		2.8		3.0		3.2	
	Rpm	Bhp	Rpm	Bhp	Rpm	Bhp	Rpm	Bhp	Rpm	Bhp	Rpm	Bhp	Rpm	Bhp	Rpm	Bhp
14,000	493	9.17	516	10.19	539	11.24	562	12.33	583	13.45	605	14.60	625	15.77	645	16.96
17,500	515	12.07	535	13.14	556	14.26	576	15.42	595	16.61	615	17.84	634	19.09	652	20.39
21,000	546	16.07	564	17.23	583	18.42	600	19.64	618	20.90	635	22.19	653	23.51	669	24.86
24,500	583	21.32	600	22.59	616	23.87	633	25.18	649	26.53	664	27.89	680	29.29	695	30.71
28,000	623	27.96	639	29.35	655	30.75	670	32.18	685	33.63	699	35.09	—	—	—	—
30,000	648	32.43	663	33.90	678	35.38	—	—	—	—	—	—	—	—	—	—

AIRFLOW (cfm)	AVAILABLE EXTERNAL STATIC PRESSURE (in. wg)							
	3.4		3.6		3.8		4.0	
	Rpm	Bhp	Rpm	Bhp	Rpm	Bhp	Rpm	Bhp
14,000	665	18.18	684	19.42	703	20.68	721	21.95
17,500	671	21.70	689	23.05	706	24.42	724	25.82
21,000	686	26.24	703	27.67	719	29.11	735	30.59
24,500	711	32.17	726	33.65	741	35.16	—	—
28,000	—	—	—	—	—	—	—	—
30,000	—	—	—	—	—	—	—	—

LEGEND

50P3,P5 units only.

Bhp — Brake Horsepower

NOTES:

1. Fan performance is based on wet coils and clean 2-in. filters.

2. See Component Pressure Drop data table before using Fan Performance tables.

3. Conversion — Bhp to kW:

$$\text{Kilowatts} = \frac{\text{Bhp} \times .746}{\text{Motor efficiency}}$$

See Physical Data table for motor efficiency.

FAN PERFORMANCE — 48/50P2,P3,P4,P5075 UNITS WITH FORWARD-CURVED FAN*

AIRFLOW (Cfm)	AVAILABLE EXTERNAL STATIC PRESSURE (in. wg)															
	0.2		0.4		0.6		0.8		1.0		1.2		1.4		1.6	
	Rpm	Bhp	Rpm	Bhp	Rpm	Bhp	Rpm	Bhp	Rpm	Bhp	Rpm	Bhp	Rpm	Bhp	Rpm	Bhp
14,000	211	2.35	243	3.06	272	3.80	299	4.59	325	5.43	349	6.30	372	7.21	395	8.15
16,000	232	3.27	261	4.06	288	4.88	313	5.74	337	6.65	360	7.59	381	8.57	402	9.58
18,000	253	4.42	281	5.31	305	6.21	329	7.14	351	8.11	372	9.12	393	10.17	413	11.25
20,000	275	5.83	301	6.82	324	7.81	346	8.82	366	9.86	386	10.94	406	12.05	425	13.20
22,000	298	7.53	321	8.62	343	9.70	364	10.80	383	11.92	402	13.07	420	14.25	438	15.46
24,000	320	9.55	342	10.75	363	11.93	383	13.11	401	14.31	419	15.54	436	16.79	453	18.07
26,000	343	11.91	364	13.22	384	14.50	402	15.78	420	17.07	437	18.37	453	19.70	469	21.05
28,000	367	14.65	386	16.06	405	17.45	422	18.83	439	20.20	455	21.59	471	23.00	486	24.43
30,000	390	17.78	408	19.31	426	20.80	443	22.28	459	23.75	474	25.24	489	26.73	504	28.24

AIRFLOW (Cfm)	AVAILABLE EXTERNAL STATIC PRESSURE (in. wg)															
	1.8		2.0		2.2		2.4		2.6		2.8		3.0		3.2	
	Rpm	Bhp	Rpm	Bhp	Rpm	Bhp	Rpm	Bhp	Rpm	Bhp	Rpm	Bhp	Rpm	Bhp	Rpm	Bhp
14,000	416	9.12	437	10.10	457	11.10	476	12.13	495	13.17	513	14.22	531	15.29	548	16.38
16,000	423	10.62	442	11.68	462	12.77	480	13.88	498	15.00	516	16.15	533	17.31	550	18.48
18,000	432	12.36	450	13.50	469	14.66	486	15.84	504	17.05	521	18.27	537	19.53	553	20.78
20,000	443	14.38	460	15.58	478	16.82	495	18.07	511	19.35	527	20.65	543	21.98	559	23.32
22,000	455	16.70	472	17.98	489	19.28	505	20.60	521	21.96	536	23.33	551	24.72	566	26.14
24,000	470	19.38	486	20.72	501	22.08	517	23.48	532	24.89	547	26.34	561	27.80	576	29.29
26,000	485	22.43	500	23.83	515	25.27	530	26.73	544	28.22	559	29.72	573	31.26	586	32.81
28,000	501	25.89	516	27.36	530	28.86	544	30.38	558	31.94	572	33.51	585	35.11	599	36.74
30,000	518	29.76	533	31.32	546	32.89	560	34.48	573	36.10	586	37.74	599	39.41	612	41.11

AIRFLOW (Cfm)	AVAILABLE EXTERNAL STATIC PRESSURE (in. wg)							
	3.4		3.6		3.8		4.0	
	Rpm	Bhp	Rpm	Bhp	Rpm	Bhp	Rpm	Bhp
14,000	564	17.47	581	18.58	596	19.71	612	20.84
16,000	566	19.68	582	20.88	597	22.10	613	23.33
18,000	569	22.06	585	23.36	600	24.66	615	25.99
20,000	574	24.68	589	26.06	604	27.45	618	28.85
22,000	581	27.57	596	29.04	610	30.51	624	31.99
24,000	590	30.80	604	32.33	617	33.88	631	35.44
26,000	600	34.39	613	35.99	627	37.61	640	39.24
28,000	612	38.38	624	40.05	637	41.74	650	43.44
30,000	624	42.81	637	44.54	649	46.29	661	48.06

LEGEND

48/50P3,P5 units only.

Bhp — Brake Horsepower

*If calculating static pressure for a 48 Series unit, be sure to add gas heat pressure drop from Component Pressure Drop table.

NOTES:

1. Fan performance is based on wet coils and clean 2-in. filters.
2. For return fan and high-capacity power exhaust units, add component pressure drop for economizer. Do not add component pressure drop for power exhaust.

3. See Component Pressure Drop data table before using Fan Performance tables.

4. Conversion — Bhp to kW:

$$\text{Kilowatts} = \frac{\text{Bhp} \times .746}{\text{Motor efficiency}}$$

See Physical Data table for motor efficiency.

Performance data (cont)



FAN PERFORMANCE — 48/50P2,P3,P4,P5075 UNITS WITH AIRFOIL FAN*

AIRFLOW (Cfm)	AVAILABLE EXTERNAL STATIC PRESSURE (in. wg)															
	0.30		0.60		0.90		1.20		1.50		1.80		2.10		2.40	
	Rpm	Bhp	Rpm	Bhp	Rpm	Bhp	Rpm	Bhp	Rpm	Bhp	Rpm	Bhp	Rpm	Bhp	Rpm	Bhp
15,000	620	3.02	671	3.91	720	4.83	767	5.80	813	6.81	858	7.87	902	8.97	944	10.10
16,000	655	3.52	703	4.45	749	5.41	794	6.42	838	7.47	881	8.56	922	9.69	963	10.86
18,000	725	4.68	769	5.71	810	6.76	851	7.84	891	8.96	930	10.12	968	11.32	1006	12.55
20,000	795	6.08	836	7.22	874	8.36	911	9.52	947	10.71	983	11.94	1019	13.20	1054	14.51
22,000	867	7.75	904	9.00	940	10.24	974	11.49	1008	12.76	1041	14.06	1073	15.39	1105	16.76
24,000	939	9.71	974	11.07	1007	12.41	1039	13.75	1070	15.11	1101	16.49	1131	17.90	1161	19.33
26,000	1012	11.99	1044	13.46	1075	14.90	1105	16.34	1134	17.79	1163	19.25	1191	20.74	1219	22.25
28,000	1084	14.61	1115	16.18	1144	17.73	1172	19.28	1200	20.82	1227	22.37	1253	23.94	1280	25.52
30,000	1157	17.60	1186	19.28	1214	20.93	1240	22.57	1267	24.22	1292	25.86	1317	27.51	1342	29.18

AIRFLOW (Cfm)	AVAILABLE EXTERNAL STATIC PRESSURE (in. wg)															
	2.70		3.00		3.30		3.60		3.90		4.20		4.50		4.80	
	Rpm	Bhp	Rpm	Bhp	Rpm	Bhp	Rpm	Bhp	Rpm	Bhp	Rpm	Bhp	Rpm	Bhp	Rpm	Bhp
15,000	984	11.25	1023	12.42	1061	13.60	1097	14.80	1131	16.00	1165	17.22	1198	18.44	1229	19.67
16,000	1003	12.06	1041	13.27	1078	14.51	1113	15.76	1148	17.02	1181	18.29	1214	19.56	1245	20.85
18,000	1043	13.82	1079	15.12	1114	16.44	1149	17.79	1182	19.15	1215	20.52	1247	21.91	1278	23.31
20,000	1088	15.84	1122	17.21	1155	18.60	1188	20.02	1220	21.47	1251	22.93	1282	24.42	1312	25.91
22,000	1137	18.15	1169	19.58	1200	21.05	1231	22.54	1261	24.05	1291	25.59	1321	27.15	1350	28.74
24,000	1191	20.79	1220	22.28	1249	23.81	1278	25.36	1307	26.94	1335	28.55	1363	30.18	1390	31.83
26,000	1247	23.78	1274	25.33	1302	26.92	1329	28.53	1356	30.18	1382	31.85	1409	33.54	1435	35.26
28,000	1306	27.12	1332	28.75	1357	30.41	1383	32.08	1408	33.79	1433	35.52	1458	37.28	1483	39.05
30,000	1367	30.86	1391	32.57	1415	34.29	1439	36.03	1463	37.81	1487	39.60	1510	41.42	1534	43.25

AIRFLOW (Cfm)	AVAILABLE EXTERNAL STATIC PRESSURE (in. wg)							
	5.10		5.40		5.70		6.00	
	Rpm	Bhp	Rpm	Bhp	Rpm	Bhp	Rpm	Bhp
15,000	1260	20.91	1290	22.15	1319	23.41	1347	24.66
16,000	1276	22.15	1305	23.45	1334	24.76	1362	26.08
18,000	1308	24.71	1337	26.13	1366	27.56	1394	28.99
20,000	1342	27.42	1370	28.95	1399	30.48	1426	32.02
22,000	1378	30.33	1406	31.95	1434	33.57	1461	35.21
24,000	1418	33.51	1445	35.20	1471	36.91	1497	38.64
26,000	1461	37.00	1487	38.76	1512	40.54	1537	42.35
28,000	1507	40.86	1532	42.69	1556	44.54	1580	46.40
30,000	1557	45.12	1580	47.01	1603	48.92	1626	50.85

LEGEND

48/50P3,P5 units only.

Bhp — Brake Horsepower

*If calculating static pressure for a 48 Series unit, be sure to add gas heat pressure drop from Component Pressure Drop table.

NOTES:

1. Fan performance is based on wet coils and clean 2-in. filters.
2. For return fan high-capacity power exhaust units, add component pressure drop for economizer. Do not add component pressure drop for power exhaust.

3. See Component Pressure Drop data table before using Fan Performance tables.

4. Conversion — Bhp to kW:

$$\text{Kilowatts} = \frac{\text{Bhp} \times .746}{\text{Motor efficiency}}$$

See Physical Data table for motor efficiency.

FAN PERFORMANCE — 48/50P2,P3,P4,P5090 UNITS WITH FORWARD-CURVED FAN*

AIRFLOW (Cfm)	AVAILABLE EXTERNAL STATIC PRESSURE (in. wg)															
	0.2		0.4		0.6		0.8		1.0		1.2		1.4		1.6	
	Rpm	Bhp	Rpm	Bhp	Rpm	Bhp	Rpm	Bhp	Rpm	Bhp	Rpm	Bhp	Rpm	Bhp	Rpm	Bhp
16,000	232	3.27	261	4.06	288	4.88	313	5.74	337	6.65	360	7.59	381	8.57	402	9.58
18,000	253	4.42	281	5.31	305	6.21	329	7.14	351	8.11	372	9.12	393	10.17	413	11.25
20,000	275	5.83	301	6.82	324	7.81	346	8.82	366	9.86	386	10.94	406	12.05	425	13.20
22,000	298	7.53	321	8.62	343	9.70	364	10.80	383	11.92	402	13.07	420	14.25	438	15.46
24,000	320	9.55	342	10.75	363	11.93	383	13.11	401	14.31	419	15.54	436	16.79	453	18.07
26,000	343	11.91	364	13.22	384	14.50	402	15.78	420	17.07	437	18.37	453	19.70	469	21.05
28,000	367	14.65	386	16.06	405	17.45	422	18.83	439	20.20	455	21.59	471	23.00	486	24.43
30,000	390	17.78	408	19.31	426	20.80	443	22.28	459	23.75	474	25.24	489	26.73	504	28.24
32,000	414	21.36	431	22.99	448	24.59	464	26.17	479	27.75	494	29.32	508	30.90	523	32.49
34,000	437	25.39	454	27.13	470	28.84	485	30.53	500	32.20	514	33.87	528	35.55	542	37.23

AIRFLOW (Cfm)	AVAILABLE EXTERNAL STATIC PRESSURE (in. wg)															
	1.8		2.0		2.2		2.4		2.6		2.8		3.0		3.2	
	Rpm	Bhp	Rpm	Bhp	Rpm	Bhp	Rpm	Bhp	Rpm	Bhp	Rpm	Bhp	Rpm	Bhp	Rpm	Bhp
16,000	423	10.62	442	11.68	462	12.77	480	13.88	498	15.00	516	16.15	533	17.31	550	18.48
18,000	432	12.36	450	13.50	469	14.66	486	15.84	504	17.05	521	18.27	537	19.53	553	20.78
20,000	443	14.38	460	15.58	478	16.82	495	18.07	511	19.35	527	20.65	543	21.98	559	23.32
22,000	455	16.70	472	17.98	489	19.28	505	20.60	521	21.96	536	23.33	551	24.72	566	26.14
24,000	470	19.38	486	20.72	501	22.08	517	23.48	532	24.89	547	26.34	561	27.80	576	29.29
26,000	485	22.43	500	23.83	515	25.27	530	26.73	544	28.22	559	29.72	573	31.26	586	32.81
28,000	501	25.89	516	27.36	530	28.86	544	30.38	558	31.94	572	33.51	585	35.11	599	36.74
30,000	518	29.76	533	31.32	546	32.89	560	34.48	573	36.10	586	37.74	599	39.41	612	41.11
32,000	536	34.11	550	35.73	563	37.38	576	39.04	589	40.73	601	42.45	614	44.18	626	45.94
34,000	555	38.92	568	40.63	581	42.36	593	44.10	605	45.87	618	47.64	630	49.45	641	51.27

AIRFLOW (Cfm)	AVAILABLE EXTERNAL STATIC PRESSURE (in. wg)							
	3.4		3.6		3.8		4.0	
	Rpm	Bhp	Rpm	Bhp	Rpm	Bhp	Rpm	Bhp
16,000	566	19.68	582	20.88	597	22.10	613	23.33
18,000	569	22.06	585	23.36	600	24.66	615	25.99
20,000	574	24.68	589	26.06	604	27.45	618	28.85
22,000	581	27.57	596	29.04	610	30.51	624	31.99
24,000	590	30.80	604	32.33	617	33.88	631	35.44
26,000	600	34.39	613	35.99	627	37.61	640	39.24
28,000	612	38.38	624	40.05	637	41.74	650	43.44
30,000	624	42.81	637	44.54	649	46.29	661	48.06
32,000	638	47.72	650	49.51	662	51.33	674	53.17
34,000	653	53.12	665	54.98	676	56.87	—	—

LEGEND

48/50P3,P5 units only.

Bhp — Brake Horsepower

*If calculating static pressure for a 48 Series unit, be sure to add gas heat pressure drop from Component Pressure Drop table.

NOTES:

1. Fan performance is based on wet coils and clean 2-in. filters.
2. For return fan and high-capacity power exhaust units, add component pressure drop for economizer. Do not add component pressure drop for power exhaust.

3. See Component Pressure Drop data table before using Fan Performance tables.
4. Conversion — Bhp to kW:

$$\text{Kilowatts} = \frac{\text{Bhp} \times .746}{\text{Motor efficiency}}$$

See Physical Data table for motor efficiency.

Performance data (cont)



FAN PERFORMANCE — 48/50P2,P3,P4,P5090 UNITS WITH AIRFOIL FAN*

AIRFLOW (Cfm)	AVAILABLE EXTERNAL STATIC PRESSURE (in. wg)															
	0.30		0.60		0.90		1.20		1.50		1.80		2.10		2.40	
	Rpm	Bhp	Rpm	Bhp	Rpm	Bhp	Rpm	Bhp	Rpm	Bhp	Rpm	Bhp	Rpm	Bhp	Rpm	Bhp
17,000	690	4.07	735	5.05	779	6.06	822	7.10	863	8.18	904	9.31	945	10.47	984	11.68
18,000	725	4.68	769	5.71	810	6.76	851	7.84	891	8.96	930	10.12	968	11.32	1006	12.55
20,000	795	6.08	836	7.22	874	8.36	911	9.52	947	10.71	983	11.94	1019	13.20	1054	14.51
22,000	867	7.75	904	9.00	940	10.24	974	11.49	1008	12.76	1041	14.06	1073	15.39	1105	16.76
24,000	939	9.71	974	11.07	1007	12.41	1039	13.75	1070	15.11	1101	16.49	1131	17.90	1161	19.33
26,000	1012	11.99	1044	13.46	1075	14.90	1105	16.34	1134	17.79	1163	19.25	1191	20.74	1219	22.25
28,000	1084	14.61	1115	16.18	1144	17.73	1172	19.28	1200	20.82	1227	22.37	1253	23.94	1280	25.52
30,000	1157	17.60	1186	19.28	1214	20.93	1240	22.57	1267	24.22	1292	25.86	1317	27.51	1342	29.18
32,000	1231	20.97	1258	22.76	1284	24.52	1309	26.26	1334	28.00	1358	29.74	1382	31.48	1406	33.23
34,000	1304	24.75	1330	26.65	1355	28.52	1379	30.36	1403	32.20	1426	34.04	1448	35.87	1471	37.71

AIRFLOW (Cfm)	AVAILABLE EXTERNAL STATIC PRESSURE (in. wg)															
	2.70		3.00		3.30		3.60		3.90		4.20		4.50		4.80	
	Rpm	Bhp	Rpm	Bhp	Rpm	Bhp	Rpm	Bhp	Rpm	Bhp	Rpm	Bhp	Rpm	Bhp	Rpm	Bhp
17,000	1022	12.91	1059	14.17	1096	15.45	1131	16.75	1165	18.06	1198	19.38	1230	20.72	1261	22.06
18,000	1043	13.82	1079	15.12	1114	16.44	1149	17.79	1182	19.15	1215	20.52	1247	21.91	1278	23.31
20,000	1088	15.84	1122	17.21	1155	18.60	1188	20.02	1220	21.47	1251	22.93	1282	24.42	1312	25.91
22,000	1137	18.15	1169	19.58	1200	21.05	1231	22.54	1261	24.05	1291	25.59	1321	27.15	1350	28.74
24,000	1191	20.79	1220	22.28	1249	23.81	1278	25.36	1307	26.94	1335	28.55	1363	30.18	1390	31.83
26,000	1247	23.78	1274	25.33	1302	26.92	1329	28.53	1356	30.18	1382	31.85	1409	33.54	1435	35.26
28,000	1306	27.12	1332	28.75	1357	30.41	1383	32.08	1408	33.79	1433	35.52	1458	37.28	1483	39.05
30,000	1367	30.86	1391	32.57	1415	34.29	1439	36.03	1463	37.81	1487	39.60	1510	41.42	1534	43.25
32,000	1429	35.00	1452	36.78	1475	38.58	1498	40.40	1520	42.24	1543	44.10	1565	45.98	1587	47.88
34,000	1493	39.57	1515	41.43	1537	43.31	1558	45.20	1580	47.11	1601	49.05	1622	50.99	1643	52.96

AIRFLOW (Cfm)	AVAILABLE EXTERNAL STATIC PRESSURE (in. wg)							
	5.10		5.40		5.70		6.00	
	Rpm	Bhp	Rpm	Bhp	Rpm	Bhp	Rpm	Bhp
17,000	1291	23.42	1321	24.77	1350	26.14	1378	27.52
18,000	1308	24.71	1337	26.13	1366	27.56	1394	28.99
20,000	1342	27.42	1370	28.95	1399	30.48	1426	32.02
22,000	1378	30.33	1406	31.95	1434	33.57	1461	35.21
24,000	1418	33.51	1445	35.20	1471	36.91	1497	38.64
26,000	1461	37.00	1487	38.76	1512	40.54	1537	42.35
28,000	1507	40.86	1532	42.69	1556	44.54	1580	46.40
30,000	1557	45.12	1580	47.01	1603	48.92	1626	50.85
32,000	1609	49.81	1631	51.76	1653	53.72	1675	55.72
34,000	1664	54.95	1685	56.96	1706	58.99	1727	61.04

LEGEND

48/50P3,P5 units only.
Bhp — Brake Horsepower

*If calculating static pressure for a 48 Series unit, be sure to add gas heat pressure drop from Component Pressure Drop table.

NOTES:

1. Fan performance is based on wet coils and clean 2-in. filters.
2. For return fan and high-capacity power exhaust units, add component pressure drop for economizer. Do not add component pressure drop for power exhaust.

3. See Component Pressure Drop data table before using Fan Performance tables.
4. Conversion — Bhp to kW:

$$\text{Kilowatts} = \frac{\text{Bhp} \times .746}{\text{Motor efficiency}}$$

See Physical Data table for motor efficiency.

FAN PERFORMANCE — 48/50P2,P3,P4,P5 100 UNITS WITH FORWARD-CURVED FAN*

AIRFLOW (Cfm)	AVAILABLE EXTERNAL STATIC PRESSURE (in. wg)															
	0.2		0.4		0.6		0.8		1.0		1.2		1.4		1.6	
	Rpm	Bhp	Rpm	Bhp	Rpm	Bhp	Rpm	Bhp	Rpm	Bhp	Rpm	Bhp	Rpm	Bhp	Rpm	Bhp
20,000	275	5.83	301	6.82	324	7.81	346	8.82	366	9.86	386	10.94	406	12.05	425	13.20
22,000	298	7.53	321	8.62	343	9.70	364	10.80	383	11.92	402	13.07	420	14.25	438	15.46
24,000	320	9.55	342	10.75	363	11.93	383	13.11	401	14.31	419	15.54	436	16.79	453	18.07
26,000	343	11.91	364	13.22	384	14.50	402	15.78	420	17.07	437	18.37	453	19.70	469	21.05
28,000	367	14.65	386	16.06	405	17.45	422	18.83	439	20.20	455	21.59	471	23.00	486	24.43
30,000	390	17.78	408	19.31	426	20.80	443	22.28	459	23.75	474	25.24	489	26.73	504	28.24
32,000	414	21.36	431	22.99	448	24.59	464	26.17	479	27.75	494	29.32	508	30.90	523	32.49
34,000	437	25.39	454	27.13	470	28.84	485	30.53	500	32.20	514	33.87	528	35.55	542	37.23
36,000	461	29.92	477	31.77	492	33.58	506	35.38	521	37.16	534	38.93	548	40.69	561	42.47
38,000	485	34.96	500	36.91	514	38.85	528	40.74	542	42.63	555	44.50	568	46.36	581	48.23
40,000	509	40.54	523	42.61	537	44.65	550	46.66	563	48.64	576	50.62	589	52.59	601	54.56

AIRFLOW (Cfm)	AVAILABLE EXTERNAL STATIC PRESSURE (in. wg)															
	1.8		2.0		2.2		2.4		2.6		2.8		3.0		3.2	
	Rpm	Bhp	Rpm	Bhp	Rpm	Bhp	Rpm	Bhp	Rpm	Bhp	Rpm	Bhp	Rpm	Bhp	Rpm	Bhp
20,000	443	14.38	460	15.58	478	16.82	495	18.07	511	19.35	527	20.65	543	21.98	559	23.32
22,000	455	16.70	472	17.98	489	19.28	505	20.60	521	21.96	536	23.33	551	24.72	566	26.14
24,000	470	19.38	486	20.72	501	22.08	517	23.48	532	24.89	547	26.34	561	27.80	576	29.29
26,000	485	22.43	500	23.83	515	25.27	530	26.73	544	28.22	559	29.72	573	31.26	586	32.81
28,000	501	25.89	516	27.36	530	28.86	544	30.38	558	31.94	572	33.51	585	35.11	599	36.74
30,000	518	29.76	533	31.32	546	32.89	560	34.48	573	36.10	586	37.74	599	39.41	612	41.11
32,000	536	34.11	550	35.73	563	37.38	576	39.04	589	40.73	601	42.45	614	44.18	626	45.94
34,000	555	38.92	568	40.63	581	42.36	593	44.10	605	45.87	618	47.64	630	49.45	641	51.27
36,000	574	44.25	586	46.03	599	47.85	611	49.67	623	51.51	634	53.37	646	55.25	657	57.14
38,000	593	50.10	605	51.98	617	53.87	629	55.77	640	57.71	652	59.63	663	61.59	674	63.54
40,000	613	56.52	625	58.49	636	60.48	648	62.46	659	64.47	—	—	—	—	—	—

AIRFLOW (Cfm)	AVAILABLE EXTERNAL STATIC PRESSURE (in. wg)							
	3.4		3.6		3.8		4.0	
	Rpm	Bhp	Rpm	Bhp	Rpm	Bhp	Rpm	Bhp
20,000	574	24.68	589	26.06	604	27.45	618	28.86
22,000	581	27.57	596	29.04	610	30.51	624	31.99
24,000	590	30.80	604	32.33	617	33.88	631	35.44
26,000	600	34.39	613	35.99	627	37.61	640	39.24
28,000	612	38.38	624	40.05	637	41.74	650	43.44
30,000	624	42.81	637	44.54	649	46.29	661	48.06
32,000	638	47.72	650	49.51	662	51.33	674	53.17
34,000	653	53.12	665	54.98	676	56.87	—	—
36,000	669	59.06	680	60.98	—	—	—	—
38,000	—	—	—	—	—	—	—	—
40,000	—	—	—	—	—	—	—	—

LEGEND

 48/50P3,P5 units only.

Bhp — Brake Horsepower

*If calculating static pressure for a 48 Series unit, be sure to add gas heat pressure drop from Component Pressure Drop table.

NOTES:

1. Fan performance is based on wet coils and clean 2-in. filters.
2. For return fan and high-capacity power exhaust units, add component pressure drop for economizer. Do not add component pressure drop for power exhaust.

3. See Component Pressure Drop data table before using Fan Performance tables.

4. Conversion — Bhp to kW:

$$\text{Kilowatts} = \frac{\text{Bhp} \times .746}{\text{Motor efficiency}}$$

See Physical Data table for motor efficiency.

Performance data (cont)



FAN PERFORMANCE — 48/50P2,P3,P4,P5100 UNITS WITH AIRFOIL FAN*

AIRFLOW (Cfm)	AVAILABLE EXTERNAL STATIC PRESSURE (in. wg)															
	0.30		0.60		0.90		1.20		1.50		1.80		2.10		2.40	
	Rpm	Bhp	Rpm	Bhp	Rpm	Bhp	Rpm	Bhp	Rpm	Bhp	Rpm	Bhp	Rpm	Bhp	Rpm	Bhp
20,000	795	6.08	836	7.22	874	8.36	911	9.52	947	10.71	983	11.94	1019	13.20	1054	14.51
22,000	867	7.75	904	9.00	940	10.24	974	11.49	1008	12.76	1041	14.06	1073	15.39	1105	16.76
24,000	939	9.71	974	11.07	1007	12.41	1039	13.75	1070	15.11	1101	16.49	1131	17.90	1161	19.33
26,000	1012	11.99	1044	13.46	1075	14.90	1105	16.34	1134	17.79	1163	19.25	1191	20.74	1219	22.25
28,000	1084	14.61	1115	16.18	1144	17.73	1172	19.28	1200	20.82	1227	22.37	1253	23.94	1280	25.52
30,000	1157	17.60	1186	19.28	1214	20.93	1240	22.57	1267	24.22	1292	25.86	1317	27.51	1342	29.18
32,000	1231	20.97	1258	22.76	1284	24.52	1309	26.26	1334	28.00	1358	29.74	1382	31.48	1406	33.23
34,000	1304	24.75	1330	26.65	1355	28.52	1379	30.36	1403	32.20	1426	34.04	1448	35.87	1471	37.71
36,000	1378	28.97	1402	30.97	1426	32.94	1449	34.89	1472	36.84	1494	38.76	1515	40.70	1537	42.64
38,000	1452	33.65	1475	35.75	1498	37.82	1520	39.89	1541	41.92	1562	43.95	1583	45.98	1604	48.01
40,000	1526	38.81	1548	41.02	1570	43.20	1591	45.35	1611	47.49	1632	49.63	1652	51.76	1671	53.88

AIRFLOW (Cfm)	AVAILABLE EXTERNAL STATIC PRESSURE (in. wg)															
	2.70		3.00		3.30		3.60		3.90		4.20		4.50		4.80	
	Rpm	Bhp	Rpm	Bhp	Rpm	Bhp	Rpm	Bhp	Rpm	Bhp	Rpm	Bhp	Rpm	Bhp	Rpm	Bhp
20,000	1088	15.84	1122	17.21	1155	18.60	1188	20.02	1220	21.47	1251	22.93	1282	24.42	1312	25.91
22,000	1137	18.15	1169	19.58	1200	21.05	1231	22.54	1261	24.05	1291	25.59	1321	27.15	1350	28.74
24,000	1191	20.79	1220	22.28	1249	23.81	1278	25.36	1307	26.94	1335	28.55	1363	30.18	1390	31.83
26,000	1247	23.78	1274	25.33	1302	26.92	1329	28.53	1356	30.18	1382	31.85	1409	33.54	1435	35.26
28,000	1306	27.12	1332	28.75	1357	30.41	1383	32.08	1408	33.79	1433	35.52	1458	37.28	1483	39.05
30,000	1367	30.86	1391	32.57	1415	34.29	1439	36.03	1463	37.81	1487	39.60	1510	41.42	1534	43.25
32,000	1429	35.00	1452	36.78	1475	38.58	1498	40.40	1520	42.24	1543	44.10	1565	45.98	1587	47.88
34,000	1493	39.57	1515	41.43	1537	43.31	1558	45.20	1580	47.11	1601	49.05	1622	50.99	1643	52.96
36,000	1558	44.57	1579	46.53	1600	48.48	1620	50.46	1641	52.44	1661	54.44	1681	56.46	1701	58.50
38,000	1624	50.05	1644	52.08	1664	54.13	1684	56.19	1703	58.25	1722	60.33	1742	62.43	1761	64.54
40,000	1691	56.01	1710	58.13	1729	60.26	1748	62.41	1767	64.55	1785	66.71	—	—	—	—

AIRFLOW (Cfm)	AVAILABLE EXTERNAL STATIC PRESSURE (in. wg)							
	5.10		5.40		5.70		6.00	
	Rpm	Bhp	Rpm	Bhp	Rpm	Bhp	Rpm	Bhp
20,000	1342	27.42	1370	28.95	1399	30.48	1426	32.02
22,000	1378	30.33	1406	31.95	1434	33.57	1461	35.21
24,000	1418	33.51	1445	35.20	1471	36.91	1497	38.64
26,000	1461	37.00	1487	38.76	1512	40.54	1537	42.35
28,000	1507	40.86	1532	42.69	1556	44.54	1580	46.40
30,000	1557	45.12	1580	47.01	1603	48.92	1626	50.85
32,000	1609	49.81	1631	51.76	1653	53.72	1675	55.72
34,000	1664	54.95	1685	56.96	1706	58.99	1727	61.04
36,000	1721	60.57	1741	62.64	1761	64.73	1781	66.85
38,000	1780	66.66	—	—	—	—	—	—
40,000	—	—	—	—	—	—	—	—

LEGEND

48/50P3,P5 units only.

Bhp — Brake Horsepower

*If calculating static pressure for a 48 Series unit, be sure to add gas heat pressure drop from Component Pressure Drop table.

NOTES:

1. Fan performance is based on wet coils and clean 2-in. filters.
2. For return fan and high-capacity power exhaust units, add component pressure drop for economizer. Do not add component pressure drop for power exhaust.

3. See Component Pressure Drop data table before using Fan Performance tables.

4. Conversion — Bhp to kW:

$$\text{Kilowatts} = \frac{\text{Bhp} \times .746}{\text{Motor efficiency}}$$

See Physical Data table for motor efficiency.

FAN PERFORMANCE — STANDARD CAPACITY POWER EXHAUST

48/50P2,P3,P4,P5030-050 UNITS

AIRFLOW (Cfm)	AVAILABLE EXTERNAL STATIC PRESSURE (in. wg)																			
	0.20		0.40		0.60		0.80		1.00		1.20		1.40		1.60		1.80		2.00	
	Rpm	Bhp	Rpm	Bhp	Rpm	Bhp	Rpm	Bhp	Rpm	Bhp	Rpm	Bhp	Rpm	Bhp	Rpm	Bhp	Rpm	Bhp	Rpm	Bhp
6,000	380	0.95	468	1.47	543	2.01	612	2.60	676	3.24	738	3.92	796	4.64	852	5.39	905	6.17	956	6.98
8,000	440	1.69	523	2.40	591	3.08	651	3.77	706	4.49	759	5.23	810	6.01	859	6.82	907	7.66	953	8.53
10,000	504	2.73	582	3.68	647	4.55	703	5.38	754	6.22	802	7.06	847	7.92	891	8.80	933	9.70	975	10.52
12,000	575	4.17	643	5.33	705	6.42	760	7.45	809	8.44	854	9.41	896	10.38	937	11.27	976	12.29	—	—
14,000	650	6.09	708	7.42	766	8.73	819	9.97	867	11.05	910	12.22	951	13.38	990	14.53	—	—	—	—
16,000	729	8.57	778	10.02	829	11.43	879	12.93	926	14.37	969	15.76	—	—	—	—	—	—	—	—
18,000	809	11.57	851	13.19	896	14.90	942	16.61	987	18.29	—	—	—	—	—	—	—	—	—	—
20,000	891	15.47	927	17.22	967	19.08	—	—	—	—	—	—	—	—	—	—	—	—	—	—

48/50P2,P3,P4,P5055-100 UNITS

AIRFLOW (Cfm)	AVAILABLE EXTERNAL STATIC PRESSURE (in. wg)																			
	0.2		0.4		0.6		0.8		1.0		1.2		1.4		1.6		1.8		2.0	
	Rpm	Bhp	Rpm	Bhp	Rpm	Bhp	Rpm	Bhp	Rpm	Bhp	Rpm	Bhp	Rpm	Bhp	Rpm	Bhp	Rpm	Bhp	Rpm	Bhp
10,000	416	1.65	469	2.03	522	2.47	574	2.97	624	3.51	673	4.08	720	4.66	765	5.26	808	5.86	850	6.47
12,000	480	2.67	524	3.09	568	3.56	612	4.09	656	4.67	699	5.29	741	5.94	782	6.61	822	7.30	861	8.00
14,000	546	4.09	584	4.55	621	5.05	659	5.61	697	6.21	735	6.87	772	7.56	809	8.28	845	9.03	881	9.80
16,000	613	5.95	647	6.46	680	7.00	713	7.59	746	8.22	779	8.90	812	9.62	845	10.37	878	11.16	910	11.98
18,000	682	8.32	712	8.88	741	9.47	771	10.10	800	10.76	830	11.47	859	12.21	889	13.00	918	13.81	—	—
20,000	752	11.27	779	11.89	805	12.53	832	13.19	858	13.90	885	14.63	911	15.41	—	—	—	—	—	—
22,000	821	14.86	846	15.53	871	16.23	895	16.94	919	17.69	—	—	—	—	—	—	—	—	—	—
24,000	892	19.16	915	19.89	—	—	—	—	—	—	—	—	—	—	—	—	—	—	—	—

Bhp — Brake Horsepower

FAN PERFORMANCE — OPTIONAL RETURN/EXHAUST FAN (48/50P2,P3,P4,P5075-100 Units)

AIRFLOW (Cfm)	AVAILABLE EXTERNAL STATIC PRESSURE (in. wg)																			
	0.2		0.4		0.6		0.8		1.0		1.2		1.4		1.6		1.8		2.0	
	Rpm	Bhp	Rpm	Bhp	Rpm	Bhp	Rpm	Bhp	Rpm	Bhp	Rpm	Bhp	Rpm	Bhp	Rpm	Bhp	Rpm	Bhp	Rpm	Bhp
14,000	594	3.61	594	3.61	617	4.02	646	4.58	674	5.16	700	5.75	725	6.36	749	6.99	772	7.62	795	8.25
16,000	619	4.09	652	4.76	681	5.40	708	6.02	733	6.65	757	7.29	781	7.94	803	8.61	825	9.30	847	9.99
18,000	687	5.57	718	6.35	746	7.07	771	7.76	795	8.45	817	9.14	839	9.85	860	10.56	881	11.20	901	11.96
20,000	756	7.37	786	8.25	812	9.06	836	9.84	858	10.59	879	11.25	900	12.03	920	12.82	939	13.62	958	14.43
22,000	825	9.50	853	10.50	878	11.31	901	12.20	923	13.06	943	13.90	962	14.75	981	15.60	1000	16.46	1018	17.33
24,000	895	11.94	922	13.08	945	14.12	967	15.10	988	16.05	1007	16.99	1026	17.91	1044	18.83	1061	19.76	1079	20.69
26,000	965	14.94	990	16.21	1013	17.36	1034	18.46	1054	19.51	1073	20.53	1091	21.54	1108	22.54	1125	23.54	1141	24.54
28,000	1035	18.43	1059	19.81	1081	21.09	1101	22.29	1120	23.45	1138	24.57	1156	25.67	1172	26.76	1189	27.83	1204	28.91
30,000	1105	22.42	1128	23.93	1149	25.33	1169	26.65	1187	27.92	1205	29.14	1222	30.34	1238	31.51	1253	32.67	1269	33.83
32,000	1176	26.96	1198	28.59	1218	30.11	1237	31.55	1255	32.93	1272	34.26	1288	35.56	1304	36.83	1319	38.08	1333	39.32
34,000	1246	32.09	1267	33.83	1287	35.47	1305	37.03	1322	38.53	1339	39.97	1355	41.38	1370	42.75	1385	44.10	1399	45.43
36,000	1317	37.83	1337	39.69	1356	41.46	1374	43.14	1391	44.75	1407	46.31	—	—	—	—	—	—	—	—
38,000	1388	44.22	1407	46.21	—	—	—	—	—	—	—	—	—	—	—	—	—	—	—	—
40,000	—	—	—	—	—	—	—	—	—	—	—	—	—	—	—	—	—	—	—	—

AIRFLOW (Cfm)	AVAILABLE EXTERNAL STATIC PRESSURE (in. wg)																			
	2.2		2.4		2.6		2.8		3.0		3.2		3.4		3.6		3.8		4.0	
	Rpm	Bhp	Rpm	Bhp	Rpm	Bhp	Rpm	Bhp	Rpm	Bhp	Rpm	Bhp	Rpm	Bhp	Rpm	Bhp	Rpm	Bhp	Rpm	Bhp
14,000	816	8.89	836	9.52	856	10.15	874	10.67	892	11.31	910	11.94	926	12.57	942	13.19	958	13.80	973	14.42
16,000	867	10.59	887	11.31	907	12.05	926	12.78	944	13.52	961	14.25	978	14.98	995	15.71	1011	16.44	1026	17.16
18,000	921	12.74	940	13.52	959	14.33	977	15.13	995	15.95	1012	16.77	1029	17.59	1046	18.42	1062	19.24	1078	20.07
20,000	977	15.25	995	16.10	1013	16.96	1031	17.82	1048	18.70	1065	19.59	1081	20.49	1097	21.39	1113	22.30	1129	23.21
22,000	1035	18.21	1052	19.10	1069	20.01	1086	20.93	1103	21.86	1119	22.81	1135	23.76	1150	24.73	1166	25.71	1181	26.69
24,000	1095	21.62	1112	22.58	1128	23.54	1144	24.51	1159	25.49	1175	26.49	1190	27.50	1205	28.52	1220	29.55	1234	30.58
26,000	1157	25.54	1173	26.55	1188	27.57	1203	28.59	1218	29.64	1233	30.68	1247	31.74	1262	32.81	1276	33.89	1290	34.98
28,000	1220	29.98	1235	31.06	1249	32.14	1264	33.23	1278	34.32	1292	35.42	1306	36.53	1320	37.65	1334	38.78	1347	39.93
30,000	1283	34.98	1298	36.13	1312	37.28	1326	38.42	1340	39.58	1353	40.74	1367	41.92	1380	43.09	1393	44.27	1406	45.46
32,000	1348	40.55	1362	41.78	1375	43.00	1389	44.22	1402	45.45	1415	46.67	—	—	—	—	—	—	—	—
34,000	1413	46.75	—	—	—	—	—	—	—	—	—	—	—	—	—	—	—	—	—	—
36,000	—	—	—	—	—	—	—	—	—	—	—	—	—	—	—	—	—	—	—	—
38,000	—	—	—	—	—	—	—	—	—	—	—	—	—	—	—	—	—	—	—	—
40,000	—	—	—	—	—	—	—	—	—	—	—	—	—	—	—	—	—	—	—	—

Bhp — Brake Horsepower

Performance data (cont)



FAN PERFORMANCE — OPTIONAL HIGH-CAPACITY POWER EXHAUST (48/50P2,P3,P4,P5075-100)

AIRFLOW (cfm)	AVAILABLE EXTERNAL STATIC PRESSURE (in. wg)									
	0.2		0.4		0.6		0.8		1.0	
	Rpm	Bhp	Rpm	Bhp	Rpm	Bhp	Rpm	Bhp	Rpm	Bhp
14,000	436	3.79	480	4.28	520	4.86	557	5.48	592	6.11
16,000	486	5.37	526	5.86	563	6.47	597	7.12	629	7.80
18,000	536	7.37	574	7.84	608	8.45	639	9.14	670	9.86
20,000	588	9.81	622	10.26	654	10.87	684	11.57	712	12.32
22,000	639	12.75	671	13.16	701	13.76	730	14.46	757	15.23
24,000	692	16.21	722	16.59	750	17.16	777	17.86	802	18.65
26,000	745	20.24	772	20.58	799	21.13	824	21.82	849	22.60
28,000	798	24.87	824	25.18	849	25.70	873	26.37	896	27.14
30,000	851	30.15	875	30.43	899	30.91	922	31.55	944	32.31
32,000	905	36.10	928	36.35	950	36.80	972	37.41	993	38.14
34,000	959	42.76	980	42.98	1001	43.40	1022	43.98	1042	44.69
36,000	1013	50.17	1033	50.37	1053	50.75	1072	51.30	1092	51.98
38,000	1067	58.36	1086	58.53	1105	58.89	1124	59.40	1142	60.05
40,000	1121	67.37	1139	67.52	1157	67.84	—	—	—	—

AIRFLOW (cfm)	AVAILABLE EXTERNAL STATIC PRESSURE (in. wg)									
	1.2		1.4		1.6		1.8		2.0	
	Rpm	Bhp	Rpm	Bhp	Rpm	Bhp	Rpm	Bhp	Rpm	Bhp
14,000	626	6.76	659	7.42	691	8.09	722	8.77	752	9.45
16,000	660	8.50	690	9.22	720	9.94	749	10.68	777	11.42
18,000	698	10.60	726	11.36	754	12.14	780	12.93	806	13.73
20,000	739	13.10	765	13.91	791	14.73	816	15.57	840	16.41
22,000	782	16.05	807	16.89	831	17.75	854	18.63	877	19.52
24,000	827	19.48	850	20.35	873	21.25	895	22.16	917	23.10
26,000	872	23.44	894	24.33	916	25.26	937	26.21	958	27.17
28,000	918	27.99	940	28.89	961	29.83	981	30.81	1001	31.81
30,000	965	33.15	986	34.06	1006	35.01	1026	36.00	1045	37.02
32,000	1013	38.98	1033	39.88	1053	40.84	1071	41.84	1090	42.88
34,000	1062	45.50	1081	46.39	1100	47.35	1118	48.36	1136	49.41
36,000	1111	52.77	1129	53.65	1147	54.59	1165	55.60	—	—
38,000	1160	60.81	—	—	—	—	—	—	—	—
40,000	—	—	—	—	—	—	—	—	—	—

AIRFLOW (cfm)	AVAILABLE EXTERNAL STATIC PRESSURE (in. wg)									
	2.2		2.4		2.6		2.8		3.0	
	Rpm	Bhp	Rpm	Bhp	Rpm	Bhp	Rpm	Bhp	Rpm	Bhp
14,000	782	10.14	811	10.83	839	11.53	866	12.23	892	12.93
16,000	805	12.18	832	12.93	858	13.69	884	14.46	910	15.23
18,000	832	14.53	858	15.35	882	16.17	907	16.99	931	17.82
20,000	864	17.27	888	18.14	911	19.01	934	19.89	957	20.78
22,000	900	20.43	922	21.34	944	22.26	966	23.20	987	24.14
24,000	938	24.04	959	25.00	980	25.98	1000	26.95	1020	27.94
26,000	979	28.17	998	29.16	1018	30.17	1037	31.20	1057	32.23
28,000	1020	32.83	1040	33.86	1058	34.91	1077	35.98	1095	37.05
30,000	1064	38.07	1082	39.14	1100	40.23	1118	41.33	1135	42.44
32,000	1108	43.95	1126	45.05	1143	46.16	1160	47.29	—	—
34,000	1153	50.49	1170	51.61	—	—	—	—	—	—
36,000	—	—	—	—	—	—	—	—	—	—
38,000	—	—	—	—	—	—	—	—	—	—
40,000	—	—	—	—	—	—	—	—	—	—

AIRFLOW (cfm)	AVAILABLE EXTERNAL STATIC PRESSURE (in. wg)									
	3.2		3.4		3.6		3.8		4.0	
	Rpm	Bhp	Rpm	Bhp	Rpm	Bhp	Rpm	Bhp	Rpm	Bhp
14,000	918	13.64	943	14.34	967	15.05	990	15.75	1013	16.46
16,000	934	16.00	959	16.77	983	17.55	1006	18.33	1029	19.11
18,000	955	18.66	978	19.50	1001	20.34	1024	21.19	1046	22.04
20,000	979	21.67	1001	22.57	1023	23.47	1045	24.38	1066	25.29
22,000	1008	25.08	1029	26.03	1050	26.99	1070	27.96	1090	28.92
24,000	1040	28.93	1060	29.94	1080	30.94	1099	31.96	1118	32.98
26,000	1075	33.27	1094	34.32	1113	35.37	1131	36.44	1149	37.51
28,000	1113	38.14	1131	39.23	1148	40.33	1166	41.44	—	—
30,000	1152	43.56	1169	44.69	—	—	—	—	—	—
32,000	—	—	—	—	—	—	—	—	—	—
34,000	—	—	—	—	—	—	—	—	—	—
36,000	—	—	—	—	—	—	—	—	—	—
38,000	—	—	—	—	—	—	—	—	—	—
40,000	—	—	—	—	—	—	—	—	—	—

LEGEND

Bhp — Brake Horsepower

COMPONENT PRESSURE DROPS (in. wg)

SIZE 030-050 UNITS

COMPONENT	AIRFLOW (cfm)							
	6,000	8,000	10,000	12,000	14,000	16,000	18,000	20,000
ECONOMIZER	0.06	0.09	0.12	0.16	0.20	0.25	0.30	0.35
FILTERS								
30% Pleated (2-in.)	0.00	0.00	0.00	0.00	0.01	0.01	0.02	0.03
Bags with Prefilters	0.22	0.31	0.41	0.52	0.64	0.76	0.89	1.03
4-in. Filters (field convert)	0.02	0.05	0.06	0.08	0.09	0.11	0.13	0.15
Cartridge Filters	0.21	0.29	0.37	0.46	0.55	0.65	0.75	0.86
POWER EXHAUST (48/50P2, P3 Units)	0.02	0.03	0.05	0.08	0.11	0.15	0.20	0.25
POWER EXHAUST (48/50P4, P5 Units)	0.09	0.15	0.22	0.30	0.41	0.53	0.66	0.81
LOW GAS HEAT (48P2,P3 Units)	0.09	0.18	0.31	0.48	0.68	0.92	1.19	1.50
HIGH GAS HEAT (48P2,P3 Units)	—	0.21	0.38	0.60	0.86	1.17	1.53	1.93
LOW GAS HEAT (48P4,P5 Units)	0.24	0.42	0.71	1.09	1.58	2.17	2.86	3.66
HIGH GAS HEAT (48P4,P5 Units)	0.08	0.22	0.46	0.79	1.20	1.71	2.31	3.01
ELECTRIC HEAT*								
36 kW	—	0.03	0.07	0.12	0.18	0.26	0.35	0.46
72 kW	—	0.06	0.11	0.18	0.26	0.36	0.47	0.60
108 kW	—	0.12	0.18	0.26	0.36	0.47	0.59	0.73
HYDRONIC COIL	0.07	0.11	0.16	0.22	0.29	0.37	0.46	0.55
HIGH-CAPACITY COIL (030)	0.041	0.055	0.070	0.087	0.104	0.123	0.143	0.165
HIGH-CAPACITY COIL (040)	0.062	0.100	0.148	0.206	0.274	0.351	0.436	0.536
HIGH-CAPACITY COIL (050)	0.045	0.067	0.099	0.142	0.195	0.259	0.333	0.417
Humidi-MiZer® SYSTEM	0.05	0.07	0.09	0.11	0.14	0.17	0.20	0.23

SIZE 055-070 UNITS

COMPONENT	AIRFLOW (cfm)										
	10,000	12,000	14,000	16,000	18,000	20,000	22,000	24,000	26,000	28,000	30,000
ECONOMIZER	0.05	0.07	0.08	0.10	0.12	0.14	0.16	0.19	0.21	0.24	0.26
FILTERS											
30% Pleated (2-in.)	0.00	0.00	0.01	0.01	0.02	0.02	0.03	0.03	0.04	0.05	0.06
Bags with Prefilters	0.45	0.56	0.68	0.81	0.94	1.08	1.22	1.38	—	—	—
4-in. Filters (field convert)	0.06	0.08	0.09	0.11	0.13	0.15	0.17	0.19	0.22	0.24	0.27
Cartridge Filters	0.42	0.52	0.62	0.73	0.84	0.96	1.08	1.21	—	—	—
POWER EXHAUST (48/50P2, P3 Units)	0.03	0.04	0.05	0.07	0.08	0.10	0.12	0.14	0.17	0.19	0.22
POWER EXHAUST (48/50P4, P5 Units)	0.12	0.17	0.22	0.28	0.34	0.42	0.50	0.59	0.68	0.78	0.82
LOW GAS HEAT (48P2,P3 Units)	0.14	0.18	0.22	0.27	0.31	0.36	0.41	0.47	0.52	0.59	0.65
HIGH GAS HEAT (48P2,P3 Units)	0.21	0.26	0.32	0.37	0.43	0.50	0.56	0.63	0.70	0.78	0.86
LOW GAS HEAT (48P4,P5 Units)	0.11	0.14	0.18	0.23	0.27	0.32	0.37	0.42	0.48	0.54	0.60
HIGH GAS HEAT (48P4,P5 Units)	0.19	0.30	0.40	0.51	0.62	0.73	0.85	0.97	1.09	1.21	1.34
ELECTRIC HEAT*											
36 kW	—	—	0.07	0.09	0.12	0.15	0.18	0.21	0.24	0.28	0.32
72 kW	—	—	0.10	0.13	0.16	0.20	0.24	0.29	0.34	0.39	0.45
108 kW	—	—	0.13	0.17	0.22	0.26	0.32	0.38	0.44	0.51	0.59
HYDRONIC COIL	0.15	0.20	0.26	0.32	0.39	0.47	0.55	0.64	0.73	0.83	0.94
HIGH-CAPACITY COIL (055-070)	0.055	0.081	0.108	0.136	0.165	0.194	0.224	0.255	0.287	0.320	0.353
Humidi-MiZer® SYSTEM	0.09	0.11	0.14	0.17	0.20	0.23	0.27	0.31	0.35	0.38	0.43

*Available on vertical return and discharge units only.

■ For interpolation purposes only. Outside of operating limits.

NOTE: Power exhaust pressure drop does not need to be added to supply fan static pressure on return fan units and on high-capacity power exhaust units.

Performance data (cont)



COMPONENT PRESSURE DROPS (in. wg) (cont)

SIZE 075-100 UNITS

COMPONENT	AIRFLOW (cfm)										
	15,000	18,000	21,000	24,000	27,000	30,000	33,000	36,000	39,000	42,000	44,000
ECONOMIZER	0.10	0.12	0.15	0.19	0.22	0.26	0.30	0.34	0.39	0.43	0.47
FILTERS											
30% Pleated (2-in.)	0.01	0.01	0.02	0.02	0.03	0.04	0.05	0.06	0.07	0.08	0.09
65% Pleated (2-in.)	0.14	0.15	0.17	0.18	0.19	0.21	0.23	0.25	0.27	0.29	0.31
4-in. Filters (field convert)	0.10	0.13	0.16	0.19	0.23	0.27	0.31	0.35	0.39	0.44	0.47
POWER EXHAUST (48/50P2, P3 Units)	0.06	0.08	0.11	0.14	0.18	0.22	0.27	0.32	0.37	0.43	0.47
POWER EXHAUST (48/50P4, P5 Units)	0.25	0.35	0.46	0.59	0.73	0.90	1.07	1.27	1.48	1.71	1.84
LOW GAS HEAT (48P2,P3 Units)	0.24	0.31	0.39	0.47	0.55	0.65	0.75	0.86	0.97	1.09	1.18
HIGH GAS HEAT (48P2,P3 Units)	0.34	0.43	0.53	0.63	0.74	0.86	0.98	1.11	1.24	1.38	1.48
LOW GAS HEAT (48P4,P5 Units)	0.21	0.29	0.37	0.45	0.53	0.61	0.70	0.78	0.87	0.96	1.02
HIGH GAS HEAT (48P4,P5 Units)	0.51	0.70	0.91	1.13	1.37	1.62	1.89	2.17	2.47	2.79	3.01
ELECTRIC HEAT*											
108 kW	0.05	0.07	0.10	0.13	0.16	0.20	0.24	0.29	0.34	0.40	0.44
216 kW	0.08	0.12	0.16	0.20	0.26	0.32	0.39	0.46	0.54	0.63	0.69
HYDRONIC COIL	0.15	0.20	0.26	0.32	0.39	0.47	0.55	0.64	0.73	0.83	0.94
HIGH-CAPACITY COIL (075-100)	0.122	0.165	0.209	0.255	0.304	0.353	0.405	0.458	0.514	0.570	0.609
Humidi-MiZer® SYSTEM (075)	0.16	0.20	0.25	0.31	0.37	0.43	0.50	0.58	0.66	0.74	0.80
Humidi-MiZer SYSTEM (090,100)	0.13	0.16	0.20	0.25	0.29	0.35	0.40	0.46	0.52	0.58	0.63

*Available on vertical return and discharge units only.

■ For interpolation purposes only. Outside of operating limits.

NOTE: Power exhaust pressure drop does not need to be added to supply fan static pressure on return fan units and on high-capacity power exhaust units.

Electrical data



Please refer to the *RTUBuilder* software for the unit electrical data. The unit electrical data may also be found in the unit Installation Instructions.

SUPPLY/EXHAUST/RETURN FAN LIMITATIONS (SIZES 030-070)

NOMINAL		MAXIMUM		MAXIMUM AMPS		RATED EFFICIENCY
Bhp	BkW	Bhp	BkW	230 v	460 v	
6	4.48	7.0	5.20	18.4	—	89.5
		7.0	5.20	—	9.2	89.5
7.5	5.60	8.7	6.49	22.0	—	91.7
		9.5	7.09	—	12.0	91.7
10	7.46	10.2	7.61	28.0	—	91.7
		11.8	8.80	—	15.0	91.7
15	11.19	15.3	11.41	43.8	—	93.0
		18.0	13.43	—	21.9	93.0
20	14.92	22.4	16.71	58.2	—	93.6
		23.4	17.46	—	28.7	93.6
25	18.65	28.9	21.56	73.0	—	93.6
		29.4	21.93	—	36.3	93.6
30	22.38	35.6	26.56	82.6	—	93.6
		34.7	25.89	—	41.7	93.6
40	29.84	42.0	31.33	—	55.0	94.5

LEGEND

Bhp — Brake Horsepower
BkW — Brake Kilowatts

NOTES:

1. Extensive motor and electrical testing on the Carrier units has ensured that the full horsepower range of the motor can be utilized with confidence. Using fan motors up to the horsepower ratings shown in the Motor Limitations table will not result in nuisance tripping or premature motor failure. Unit warranty will not be affected.
2. All motors comply with the Energy Independence Security Act (EISA) of 2007.

SUPPLY/EXHAUST/RETURN FAN LIMITATIONS (SIZES 075-100) (DOES NOT INCLUDE HIGH CAPACITY POWER EXHAUST)

NOMINAL HP	BkW	MAX BHP	MAX BkW	MAX AMPS		RATED EFFICIENCY
				460 V	575 V	
10	7.46	10.2	7.61	28.0	N/A	91.7
15	11.2	15.3	11.4	43.8	N/A	93.0
20	14.9	22.4	16.7	58.2	N/A	93.6
25	18.7	28.9	21.6	73.0	N/A	93.6
30	22.4	34.7	25.9	48.0	N/A	93.6
40	29.8	42.0	31.3	55.0	N/A	94.5
50	37.3	57.5	42.9	71.0	N/A	94.5
60	44.8	69.0	51.5	75.0	N/A	95.4
75	59.5	86.3	64.3	95.5	N/A	95.4

LEGEND

Bhp — Brake Horsepower
BkW — Brake Kilowatts
N/A — Not Available

NOTES:

1. Extensive motor and electrical testing on the Carrier units has ensured that the full horsepower range of the motor can be utilized with confidence. Using fan motors up to the horsepower ratings shown in the Motor Limitations table will not result in nuisance tripping or premature motor failure. Unit warranty will not be affected.
2. All motors comply with the Energy Independence Security Act (EISA) of 2007.

Electrical data (cont)



OPTIONAL HIGH-CAPACITY POWER EXHAUST SYSTEMS MOTOR LIMITATIONS (SIZES 075-100)

NOMINAL HP	BkW	MAX BHP	MAX BkW	MAX AMPS (EA)		RATED EFFICIENCY
				460 V	575 V	
20	14.9	23.6	17.6	15.0	N/A	91.7
30	22.4	36.0	26.9	21.9	N/A	93.0
40	29.8	46.8	34.9	28.7	N/A	93.6
50	37.3	58.8	43.9	36.3	N/A	93.6
60	44.8	69.0	51.5	41.7	N/A	93.6

LEGEND

Bhp — Brake Horsepower
BkW — Brake Kilowatts

NOTES:

1. Extensive motor and electrical testing on the Carrier units has ensured that the full horsepower range of the motor can be utilized with confidence. Using fan motors up to the horsepower ratings shown in the Motor Limitations table will not result in nuisance tripping or premature motor failure. Unit warranty will not be affected.
2. All motors comply with the Energy Independence Security Act (EISA) of 2007.

Control components

The 48/50P Series rooftops use the *ComfortLink* control system that has been developed for use in Carrier Commercial equipment. The control system monitors all operating conditions in the rooftop unit as well as controlling the compressors, economizers, fans, heat and other devices. It also has the capability of communicating with the Carrier Comfort Network® devices using the CCN (Carrier Comfort Network®) protocol and other popular protocols including BACnet, MODBUS, LonWorks, etc.

The system uses a microprocessor and a series of boards, each with inputs and outputs. A local network communications bus (LEN) ties all the boards together into a system and enables the boards to communicate.

For the 48/50P Series, the control consists of the following key components:

Main base board (MBB) — The MBB is the center of the *ComfortLink* control system. It contains the major portion of the operating software and controls the operation of the unit. The MBB continuously monitors inputs and controls outputs, as well as sends and receives data over the LEN and CCN communications channels. The board is located in the main control box.

Rooftop control board (RXB) — The RXB controls many unit functions. The RXB controls the actuators for the economizer hydronic heating valve and humidifier valve using a digital communications signal. This signal also provides operation and diagnostic data on the actuators. The RXB also has relay outputs to control condenser fans, second stage power exhaust, minimum load valve and the heat interlock output. The RXB board is located in the main control box.

Compressor expansion board (CXB) — The CXB provides additional compressor control outputs and is used on models with more than four compressors. This board is located in the main control box.

Options control board (EXB) — The EXB is used on units with the optional return fan, digital scroll compressors or when control of a humidifier is required. This board is located in the main control box.

Expansion valve board (EXV) — The EXV board is located in the main control box.

Staged gas heat board (SCB) — When the optional staged gas heat is used, the SCB board will be installed and control the operation of the gas valves. It also provides additional sensors for monitoring of the supply-air temperature. This board is located in the main control box.

Modulating gas heat boards — When the optional modulating gas heat is used, one timer relay board (TR1) and one signal conditioner board (SC30) will be installed in the heating compartment. The two boards in combination with SCB board provide control to the modulating gas heat section. Refer to the Unit Controls and Troubleshooting book for information on modulating gas control.

Integrated gas controller (IGC) — One IGC is provided with each bank of gas heat exchangers. It controls the direct spark ignition system and monitors the rollout switch, limit switches, and induced-draft motor Hall Effect sensor. For units equipped with modulating gas heat, the

induced-draft motor function is proven with a pressure switch. The IGC is equipped with an LED for diagnostics.

Controls expansion module (CEM) — The optional expansion module is used to provide inputs for supply air set point reset, static pressure reset, demand limiting, outdoor air quality and other optional inputs. It is located in the main control box.

Compressor protection Cycle-LOC™ board (CSB) — This board monitors the status of the compressor by sensing the current flow to the compressors and then provides digital status signal to the MBB.

Scrolling marquee display — This device is the keypad interface used to access the control information, read sensor values, test the unit, and monitor alarm status. The scrolling marquee display is a 4-key, 4-character, 16-segment LED (light-emitting diode) display. The display is very easy to operate using 4 buttons and a group of 11 LEDs that indicate the following menu structures:

- Run Status
- Outputs
- Service Test
- Configuration
- Temperatures
- Timeclock
- Pressures
- Operating Modes
- Set Points
- Alarms
- Inputs

Through the display, inputs and outputs can be checked for their value or status. Because the unit is equipped with suction pressure transducers and discharge saturation temperature sensors it can also display pressures typically obtained from gages. The control includes a full alarm history which can be accessed from the display. Through the display, a built-in test routine can be used at start-up commissioning and during maintenance inspections to help diagnose operational problems with the unit.

Cooling control options

When mechanical cooling is required, the P Series *ComfortLink* controls have the capability to control the staging of the compressors in several different ways. Two scroll compressors are used on size 030 and 035 units, three scroll compressors on 040 units, four scroll compressors are used on sizes 050 to 075 and six scroll compressors are used on sizes 090 and 100. In addition, a digital unloading type scroll compressor is standard on 30 and 35 ton VAV units and available as an option on all other units.

The *ComfortLink* controls also support the use of an optional minimum load hot gas bypass valve (MLV) with the Multiple Adaptive Demand and VAV control sequences. The MLV is directly controlled by the *ComfortLink* controls and provides an additional stage of capacity as well as low load coil freeze protection. The control also integrates the use of an economizer with the use of mechanical cooling to allow for the greatest use of free cooling. When both mechanical cooling and the economizer are being used, the control will use the economizer to provide better temperature control and limit the cycling of the compressors.

Controls (cont)



The control also checks on various other operation parameters in the units to make sure that safety limits are not exceeded and the compressors are reliably operated.

The P Series *ComfortLink* controls offers three control approaches to mechanical cooling: constant volume, SAV™, and VAV, all with multiple stages of cooling.

COOLING CONTROL OPTIONS

CONTROL TYPE			COOLING CONTROL METHOD
Unit	Application	Demand Source	
P2,P4	CV,SAV	SPT or TSTAT	Multiple Adaptive Demand
P3,P5	VAV	RAT or SPT	Multiple Stage EDT

Control type — The control type determines the selection of the type of cooling control as well as the technique for selecting a cooling mode. The control types are:

VAV-RAT and VAV-SPT — Both of these configurations refer to standard VAV operation. If the control is occupied, the supply fan is run continuously and return-air temperature will be used in the determination of the selection of the cooling mode. VAV-SPT differs from VAV-RAT only in that during the unoccupied period, space temperature will be used instead of return-air temperature to start the fan for ten minutes before the return-air temperature is allowed to call out any mode.

CV SAV TSTAT-Multiple Stage — This configuration will force the control to monitor the thermostat inputs (Y1,Y2) to make a determination of mode. Unlike traditional 2-stage thermostat control, the unit is allowed to use multiple stages of cooling control and perform VAV-style capacity control.

CV SAV SPT-Multiple Stage — This configuration will force the control to monitor a space temperature sensor to make a determination of mode. The unit is allowed to use multiple stages of cooling control and perform VAV-style capacity control.

Cooling control method — Two different cooling control methods are used to step through the available stages of capacity. Depending on the unit size, cooling control method and presence of an MLV, this may range from 2 up to 5 stages of capacity control. These methods are:

Multiple Stage Evaporator Discharge Temperature (EDT) — The capacity of the economizer and compressors are controlled based on the evaporator air discharge temperature and supply air temperature set point. This control method uses an adaptive PID (proportional, integral, derivative) algorithm to calculate the estimated change in supply-air temperature before engaging or disengaging the next stage of cooling. The algorithm compensates for varying conditions, including changing flow rates across the evaporator coil, to provide better overall control of compressor staging.

Multiple Adaptive Demand — This control method will base the capacity of the economizer and compressors on the evaporator air discharge temperature and one of two supply air temperature set points. The control will be able to call out a LOW COOL or a HIGH COOL mode and

maintain a low or high cool supply air set point. The unit will use either the input from a conventional thermostat to turn the Y1, Y2 signals into a high and low demand signal, or with a space temperature sensor use a differential from set point to determine the mode. Once the mode has been established the control uses the same algorithm as with VAV control.

Integrated economizer — For each of the above modes of operation all mechanical cooling will first be delayed while the unit attempts to use the economizer for free cooling. Once the economizer is at full capacity, the control will then supplement the free cooling with as much mechanical cooling as required. To prevent any rapid changes in cooling, the control will also use the economizer to trim the cooling supplied.

Heating control options

When heating is required the P Series units can be provided with 2-stage electric heat, 2-stage gas heat, multiple-stage gas heat, modulating gas heat or modulating hydronic heat. Depending on unit size and heating capacity the multiple-stage gas heating option may have between 5 and 9 stages of heating capacity control. Modulating gas heat provides variable heating loads depending on unit size and overall heating capacity. The P Series *ComfortLink* controls have the capability to control the heating capacity based on input from a 2-stage mechanical thermostat, a space temperature sensor, or on VAV units by the return air temperature sensor. With CV units the heating mode (off, low or high) will be enabled based on W1 and W2 thermostat inputs, or when using a space temperature sensor the differential from heating set point will be used. Heating with VAV units will be enabled based on the return-air temperature or the space temperature, but once enabled control will be based on the return-air temperature. Variable air volume terminals will be commanded open to the heating cfm through linkage or the heat interlock relay. The P Series *ComfortLink* controls will use one of the following control methods:

Two-stage control (gas or electric heat) — The unit will operate in LOW HEAT or HIGH HEAT mode as determined by the demand inputs. In the LOW HEAT mode if the temperature sensed by the evaporator discharge temperature sensor is below 50 F, the unit will automatically go into a HIGH HEAT mode.

Multiple-stage and modulating control (gas heat only) — When the unit is in a LOW HEAT mode the algorithm calculates the desired heat capacity based on set point and supply-air temperature. The staged gas control logic will stage the heating capacity to match the calculated demand. Units with modulating control logic will continuously modulate the heating capacity to match the calculated demand. When the unit is in a HIGH HEAT mode all stages of heat will be activated. In case the modulating option is selected, the control will maintain the maximum heating capacity. Both staged and modulating gas heat options can also be used in a TEMPERING mode. This mode is enabled during a VENTILATION, LOW COOL or HIGH COOL mode when the economizer dampers are at their minimum ventilation position and the mixed-air temperature is below the supply air set point. Tempering

can also be used during a preoccupancy purge to prevent low temperature air from being delivered to the space.

Modulating hydronic coil control — When the unit is in a LOW HEAT mode the algorithm calculates the desired heat capacity based on set point and supply-air temperature. The valve control logic will modulate the heating capacity to match the calculated demand. When the unit is in a HIGH HEAT mode the modulating valve will go to a full open position. Modulating hydronic heat can also be used in a TEMPERING mode. This mode is enabled during a VENTILATION, LOW COOL or HIGH COOL mode when the economizer dampers are at their minimum ventilation position and the mixed-air temperature is below the supply air set point. Tempering can also be used during a preoccupancy purge to prevent low temperature air from being delivered to the space.

Economizer and IAQ options

The controls have been designed to support the requirements of indoor air quality control through the use of outside air. Units can either be equipped with an outside air adjustable, self-closing economizer or a fully modulating, gear driven economizer with no linkages. The economizer can be configured for a full modulation mode or 3-position mode of operation. The control includes logic for a minimum ventilation position and different set points for occupied and unoccupied minimum position set points. This control also has logic built in to calibrate the economizer position to the actual percentage of outside air introduced. During periods when the compressors are not being used the control will use the RAT, SAT and OAT to calibrate the economizer. This will allow for setting the outside air actual percentage and not just the percent damper position.

The use of the economizer will depend on the mode of change selected. This control integrates the changeover directly into the control. Five types of changeover are available:

- Outdoor air dry bulb
- Differential dry bulb
- Outdoor air enthalpy
- Differential enthalpy
- Outdoor air dew point

The units are provided with an outdoor air and return air temperature sensor so the first two changeover methods are available as standard. To use the enthalpy changeover options the control supports the addition of highly reliable, electronic humidity sensors. The humidity sensor input is then used with the dry bulb sensors to calculate the enthalpy. For outdoor enthalpy changeover the control also has the ASHRAE 90.1 — A, B, C, D economizer changeover curves built into the software. When operating with outside air economizers, large amounts of air can be introduced into the building and a means must be provided for building pressure relief. The 48/50P Series control supports the following types of building pressure control:

- Barometric Relief Dampers — Can be used on low return duct static applications
- Non-Modulating Two-Stage Power Exhaust — The unit can be equipped with two power exhaust fans. The

software controls the power exhaust stages based on the economizer position (percent open).

- Modulating Power Exhaust — Both the VAV and CV units can be equipped with modulating power exhaust. The exhaust airflow is controlled by the use of a VFD on both exhaust fans. The *ComfortLink* controls modulate the fan speed to maintain the building pressure set point.
- High-Capacity Modulating Power Exhaust (size 075-100 units only) — Both the VAV and CV units can be equipped with high-capacity modulating power exhaust. The exhaust airflow is controlled by the use of a VFD on the lead exhaust fan. The *ComfortLink* controls modulate the lead fan speed to maintain the building pressure set point. The second exhaust fan is energized when additional exhaust airflow is required.
- Modulating Return Fan (size 075-100 units only) — Both the VAV and CV units can be equipped with modulating return fan. The primary function of a return fan is to handle return duct losses, allowing the supply fan to handle only internal and supply static load. Return fans should never be used on systems with less than 0.5-in. wg return static. The return fan runs whenever the supply fan is operating and its speed is controlled by a variable frequency drive. The *ComfortLink* controls measure the supply fan airflow and adjusts the return fan speed to maintain a programmed airflow differential. The airflow differential is dynamically adjusted to maintain building pressure set point.

The units are capable of using either 2-in. fiberglass/pleated media, 12-in. deep cartridge filters (030-070 only) or optional 22-in. deep bag filters (size 030-070 units only) and can have an optional filter pressure drop switch to warn of dirty filter conditions. Additionally the standard 2-in. angle filter track can be field modified to accept 4-in. deep filters.

The indoor air quality (IAQ) function provides a demand-based control for ventilation air quantity, by providing a modulating outside air damper position that is proportional to the space CO₂ level. The ventilation damper position is varied between a minimum ventilation level (based on internal sources of contaminants and CO₂ levels other than the effect of people) and the maximum design ventilation level (determined at maximum populated status in the building). During a less-than-fully populated space period, the CO₂ level will be lower than that at full-load design condition and will require less ventilation air. Reduced quantities of ventilation air will result in reduced operating costs. Space CO₂ levels are monitored and compared to user-configured set points. Accessory CO₂ sensor for space (or return duct mounting) is required. The IAQ routine can be enhanced by also installing a sensor for outdoor air quality.

During the occupied period, in the absence of a demand for cooling using outside air, if CO₂ levels are below the set point for the minimum ventilation level, the outside-air damper will open to the minimum ventilation level damper position set point. The minimum damper position will be maintained as long as the CO₂ level remains below the set point.

Controls (cont)



When the space CO₂ level exceeds set point for the minimum ventilation level condition, the *ComfortLink* controls will begin to open the outside air damper position to admit more ventilation air and remove the additional contaminants. As the space CO₂ level approaches the set point for maximum design ventilation level condition, the outside air damper position will reach the maximum ventilation level damper position set point limit. Damper position will be modulated in a directly proportional relationship between these two CO₂ set point limits and their corresponding damper position limits.

In most applications a fixed reference value can be set for the outdoor air quality level, but the control also supports the addition of an outdoor air quality sensor that will be compared to the indoor or return IAQ sensor. If an OAQ (outdoor air quality) sensor is connected, the demand set point levels will be adjusted automatically as the outdoor CO₂ levels vary. Also, if the outdoor CO₂ level exceeds a user-configured maximum limit value, then outside air damper position will be limited to the minimum ventilation damper set point value. The control can also receive these signals through the CCN system.

The IAQ and OAQ measurement levels are displayed by the *ComfortLink* scrolling marquee in parts per million (ppm).

Outdoor air CFM control — Minimum space ventilation requirements can also be maintained by applying the minimum outdoor air cfm control option. This option provides an airflow monitoring station at the outside air damper inlet. The *ComfortLink* controls can be programmed to monitor this airflow rate and to override the current outside air damper position to maintain a minimum quantity of outdoor air at the user's design set point even as the unit's supply fan slows during part load operating periods.

Fire and smoke controls interface — The unit can be equipped with an optional return air smoke detector. The smoke detector is wired to stop the unit and send a message to a remote alarm system if a fault condition is detected. If the controls expansion module is added, the control will support smoke control modes including evacuation, smoke purge, and pressurization.

Demand limiting — The control supports demand limiting using one or two fixed capacity limits initiated by discrete input switches or a variable capacity limit function based on an analog input signal. On CCN systems this can be done through the network, or for non-CCN network jobs this can be done by adding the controls expansion module.

Diagnosics

The *ComfortLink* controls have fully integrated all controls and sensors into a common control system. The control monitors these inputs as well as many of the routines to provide advanced diagnostics and prognosics. These include adaptive logic to allow the unit to continue to operate in a reduced output mode and automatic resets where applicable. The last 10 alarms and alerts are stored in memory and can be accessed through the display. The alarms can also be monitored through the Carrier Comfort Network® connection. The unit also supports the use of the

hand held Navigator™ display which can be plugged in at the main control box and auxiliary control box at the opposite end of the unit.

Some of the diagnostics that are included are:

- Monitoring of all sensors
- Suction pressure transducers to provide compressor protection and coil freeze protection
- Monitoring of the economizer motor using a digitally controlled motor
- Monitoring of compressor status using compressor protection boards
- Adaptive logic for low supply-air temperatures
- Compressor lockout at low ambient conditions
- Storage of compressor run hours and starts
- Low refrigerant charge protection
- Compressor reverse rotation protection

Control interface

The *ComfortLink* controller can interface with an i-Vu® Open control system, a BACnet building automation system, or Carrier Comfort Network devices. This will allow for the use of all system control programs. These include:

- Network Service Tool
- System Pilot™ device
- Touch Pilot™ device
- i-Vu Open control system software
- ComfortVIEW™ software
- CCN Web software
- ComfortID™ system

Contact Carrier Controls Marketing for more information. The control can also provide interface with other energy management systems with the addition of either the BACnet/MODBUS Carrier translator or the LonWorks Carrier translator.

Several contact connection points have been provided in the main control box for interface to external controls and systems. External controls use the following interface points:

- Start/Stop (On/Off) — Start/Stop is accomplished with a contact closure between terminals 3 and 4 on TB201.
- Remote Economizer Enable — Enabling and disabling of the economizer can be done by connecting a contact closure to terminals 5 and 6 on TB201. The economizer can be configured for a switch closure changeover for 3-position operation.
- VAV Heating Interlock — Interface with non-linkage terminals can be done through TB201 terminals 9 and 10.
- Remote IAQ Inputs — External IAQ demand inputs can be connected through terminals 7 and 8 on TB201.
- Smoke Detectors Alarm Output — Remote detector alarm outputs can be connected through terminals 1 and 2 on TB201.
- Fire Shutdown — A remote fire shutdown signal can be connected to 1 and 2 on TB201. The software can be configured to shut the unit down on an open or closed signal.
- Fire Pressurization — For a remote control of pressurization a contact closer can be connected to terminals 18 and 19 on TB202. In this mode the economizer

damper will be fully opened and the supply fan turned on to pressurize the space.

- **Fire Evacuation** — For this mode a remote contact closure can be connected to terminals 16 and 17 on TB202. For remote evacuation of a space the outside-air dampers will be opened and the power exhaust fans turned on to evacuate the space of smoke.
- **Fire Purge** — For this mode external contacts can be connected to terminals 14 and 15 on TB202. In this mode the supply fan and return fans will be turned on with the economizer at a full open position.
- **Demand Limiting** — For demand limiting the controls expansion module must be used. Connections are provided on TB202 for switch input demand limiting (terminals 20 and 21, 22 and 23) and for 4 to 20 mA (terminals 10 and 11) demand limit signals.
- **Dehumidification** — A discrete input is available on TB202, terminals 24 and 25 to initiate the Dehumidification mode.
- **Remote Supply Air Set Point** — A remote supply air temperature set point reset can be supported when the controls expansion module is used. This input requires a 4 to 20 mA signal. It can be connected to terminals 8 and 9 on TB202.
- **Remote Static Pressure Reset Set Point** — A remote supply air temperature set point reset can be supported when the controls expansion module is used. This input requires a 4 to 20 mA signal. It can be connected to terminals 7 and 8 on TB202. This input is shared with the Outdoor Air IAQ signal.
- **Outdoor Air IAQ Signal** — If an external outdoor air signal is being used then it can be connected to terminals 7 and 8 on TB202. This input requires a 4 to 20 mA signal. This input is shared with the Remote Static Pressure Reset signal.
- **IAQ Switch Input** — If an external control will be controlling IAQ then it can be connected as a contact closure through terminals 12 and 13 on TB202.
- **Space Humidity** — A space humidity sensor can be used to enable the dehumidification and humidifier control logic. It can be connected to terminals 3 and 4 on TB202. This input requires a 4 to 20 mA signal.
- **Humidifier Control Output** — A contact closure out can be provided to enable the operation of a field-provided humidifier. The output can be connected to terminals 1 and 2 on TB201.

Carrier can also support electronic interface to other systems using the following;

- BACnet/MODBUS Carrier translator (read/write, provides CCN to BACnet master-slave/twisted-pair [MS/TP] or MODBUS remote terminal unit [RTU] protocol conversion)
- LonWorks Carrier translator (read/write, provides CCN to LON FT-10A ANSI/EIA-709.1 protocol conversion)

Constant volume and staged air volume applications

The 48/50P2,P4 units are designed to operate in CV and SAV™ applications. The units are shipped as operable, stand-alone units using either a standard (mechanical or electronic) 2-stage heat, 2-stage cool thermostat, or with

an electronic room temperature sensor and a timeclock to establish unit start and stop times. With a standard thermostat (programmable is optional), heating and cooling operation is set by space temperature. With a space sensor and field-supplied timeclock, the machine will operate at default values unless they are changed using appropriate input devices. The space sensor monitors space temperature and may be equipped with a timed override feature, which allows unit operation during unoccupied periods. The space sensors may be used in multiples of 4 or 9 to achieve space temperature averaging. The use of a space sensor also allows the unit to be turned on and off from a remote signal or it can be programmed to use the time of day scheduling that is built into the control.

Features with thermostat control of unit

- Two-stage heating (if installed)
- Multiple stage gas heating if unit is equipped with the staged gas heat option
- Modulating gas heating if unit is equipped with the modulating gas heat option
- Two-stage demand with fully proportional economizers and integrated compressor capacity
- Adaptive multiple stage cooling which can provide up to 6 stages of capacity
- Control of unit using Y1, Y2, W1, W2, and G thermostat or T55, T56, or T58 space sensors
- Control of the indoor fan
- Outdoor-air temperature/supply-air temperature monitoring with logic to lock the compressors out at low ambient temperatures down to 32 F (-20 F with Motor-master® control)
- Control of a condenser fan based on outdoor-air and condensing pressures
- Control of modulating economizer to provide free cooling when outdoor conditions are suitable
- Control allows for use of the economizer and the compressors to maximize the use of outside air cooling to reduce part load operating costs
- Control of the power exhaust fans based on configurable economizer damper positions or directly from the optional building pressure sensor
- Compressor time guard override (power up and minimum on and off timers) to assure air return in low load conditions
- Support of IAQ sensor

Features with sensor control of unit — There are 3 sensor options available:

- T55 sensor will monitor room temperature and provide unoccupied override capability (1 to 4 hours).
- T56 sensor will monitor room temperature, provide unoccupied override capability (1 to 4 hours), and provide a temperature offset of 5 F maximum.
- T58 is a CCN communicating sensor that will provide the set point and space temperature values.

Standard features are:

- Support of remote occupied/unoccupied input to start and stop the unit
- Two-stage economizer demand with fully proportional economizers and integrated compressor capacity

Controls (cont)



- Adaptive cooling capacity control with up to 6 stages of mechanical refrigeration capacity
- Variable capacity control with digital scroll compressor option
- Occupied or unoccupied set point
- Enable heating (if installed) or cooling during unoccupied periods as required to maintain space temperature within the unoccupied set points
- Adjustment of space temperature set points of $\pm 5^\circ\text{F}$ when using a T56 sensor
- Support of IAQ sensor
- 365-day timeclock with backup (supports minute, hour, and day of week, date, month, and year access). The timeclock includes the following features:
 - Daylight savings time function
 - Occupancy control with 8 periods for unit operation
 - Holiday table containing up to 18 holiday schedules
 - Ability to initiate timed override from T55 or T56 sensors (for a timed period of 1 to 4 hours)
 - Temperature compensated start to calculate early start times before occupancy
 - For units connected into a CCN network the time clock can be integrated into the overall building energy management system and be updated remotely
- For units connected to the CCN network the user can also display all the unit information including I/O values Maintenance, Configuration, Service, and Set Point data tables
- Indoor air quality (IAQ)

Variable air volume (VAV) applications

The 48/50P3,P5 units are designed to operate in VAV applications. As an option, they include a supply fan inverter (VFD) to control the supply fan speed and duct pressure. They are designed to control the leaving-air temperature in cooling to a configurable set point. The changes in mode of operation from Heating to Vent to Cooling mode can be controlled either from the return air temperature sensor or from an accessory space temperature sensor. Some of the features for VAV units in a stand-alone application are:

- The units are shipped as operable, stand-alone units with the addition of a field-supplied timeclock to establish unit start and stop times or they can use *ComfortLink* time of day scheduling routine
- Provide cooling and heating control (if equipped with heat) in both occupied and unoccupied modes
- Supports an optional space temperature sensor for mode control and supply air temperature reset
- If space sensor is equipped with an override feature, the sensor will allow operation during the unoccupied period for a fixed length of time
- Base unit control supports a heat interlock relay (field supplied) to signal the VAV terminal devices to fully open during heating operation
- Control board diagnostics
- Control of an outdoor-condenser fan based upon outdoor-air temperature and saturated condensing temperature
- Control of modulating economizer to provide free cooling when outdoor conditions are suitable.

- Control also allows for use of the economizer and the compressors to maximize the use of outside air cooling to reduce part load operating costs
- Support of remote occupied/unoccupied input to start
- Controls the operation of the supply fan inverter to maintain a configurable supply duct static pressure set point. Inverter is configured and controlled directly by *ComfortLink* controls
- Support of IAQ sensor
- Support a field test for field check out
- Support linkage to *ComfortID™* systems
- Cooling capacity control of up to 6 stages plus economizer
- Variable capacity control with digital scroll compressor option
- Control of two stages of heat to maintain return-air temperature
- Multiple stage gas heating if unit is equipped with the staged gas heat option
- Control of heat interlock relay
- Compressor time delays to prevent rapid cycling of compressors
- Automatic lead-lag control of compressors to reduce the number of compressor cycles
- With the addition of a remote start/stop switch heating or cooling is enabled during unoccupied periods as required to maintain space temperature to within unoccupied set points
- With the addition of the controls expansion board, the *ComfortLink* controls will also support demand limiting and remote set point control

When the unit is connected to a CCN (Carrier Comfort Network®) system, additional features can be used:

- Interface of the unit clock with the CCN network clock and allow for remote configuration of the schedules
- CCN demand limit participation
- Interface with *ComfortID™* control systems through linkage

Sequence of operation

Cooling, constant volume (CV, SAV™) units —

On power up, the control module will activate the initialization software. The software will determine the unit configuration and initialize any controls loops and input/output devices. All alarms and configurations are saved in memory and maintained during power outages. Alarms will be maintained in memory and must be cleared using the display.

Constant volume and staged air volume conventional thermostat control —

If the unit is equipped with a conventional thermostat with Y1, Y2, W1, W2 and G connections then the control will perform the following sequence:

When G is closed the indoor fan will turn on. G must be closed for heating or cooling to occur.

Cooling — If Y1 is closed then the control will first check the ability to use the economizer. If the economizer can be used, the control will modulate the damper open to maintain the low load economizer leaving air temperature set point.

If Y2 is closed then the control will lower the leaving air temperature set point to the configured set point. If the economizer can not satisfy the load then compressors will be sequenced on to maintain either the low or high load temperature set points.

If the economizer cannot be used or the enabled control disables the economizer, then the control will sequence the compressors based on Y1 and Y2 signals. The control will add and remove compressor stages to maintain the low and high demand leaving air set points. If Y1 is closed at least one compressor stage will be turned on.

Heating — If W1 is closed this indicates that the unit should be in Heating mode. The economizer will close to the minimum position, and if the unit is equipped with gas or electric heat then the first stage of heat will energize.

If W2 is closed then the control will turn on the second stage of heat. If the unit is equipped with a staged gas or modulating heat control option then the W1 signal will be used to control the gas heat to the configurable low heat load leaving air temperature set point. When W2 is energized, the unit will fire all stages of heat capacity. If the unit is equipped with gas heat then the IGC board will control the operation of the gas heat. See the 48 Series Gas Heat units section for the IGC board sequence of operation.

If the unit has hydronic heat option then the W1 signal will control the modulating control valve to the configurable low heat load leaving air temperature set point. When W2 is energized, the modulating control valve will go to 100% open position.

Constant volume and staged air volume space temperature sensor control — If the space temperature operation has been selected using a T55, T56, or T58 sensor then the following logic will be used to control the operation of the unit. If a space temperature is used then a wire jumper must be added between R, W1, and W2.

If a remote occupancy control method has been selected then the input must first be closed for the unit to go into Heating, Vent or Cooling mode. If the internal timeclock is used, the control module determines the occupancy state based on the system time schedule.

If Temperature Compensated Start is active, the unit will be controlled in occupied mode and will start at a time determined by prior operation to have the space at a set point by the occupied time.

Vent — If the unit has been configured for a pre-occupancy purge then the control will start the unit in Vent mode prior to the occupancy time to vent the space. If an IAQ sensor is being used and the low IAQ set point is satisfied then the occupancy purge mode will be terminated. The set points for heating and cooling are configurable using the display. If a T56 sensor is being used then the set point can be shifted by as much as 5 degrees.

Cooling — If the space temperature goes above the cooling set point then the unit will go into Cooling mode. If the economizer can be used, the control will first try to achieve the leaving air temperature set point. The set point will depend on the space temperature. If the temperature is above the low demand set point then the low economizer load discharge air temperature set point will be used. If the

temperature is above the high load space temperature set point then the high load leaving air temperature set point will be used. If the economizer can not satisfy the load then compressors will be sequenced on to maintain either the low or high load temperature set points.

If the economizer can not be used or the enable control disables the economizer then the control will sequence the compressors based on the low and high load space temperature variables. The control will add and remove compressor stages to maintain the high and low demand leaving air set points.

Heating — If the space temperature goes below the heating space temperature set point then it will indicate that the unit should be in the Heating mode. The economizer will be closed to the minimum position and if the unit is equipped with gas or electric heat then the first stage of heat will be energized.

If the space temperature goes below the high load space temperature set point then the control will turn on the second stage of heat. If the unit is equipped with a staged gas heat control option then the low load demand signal will turn on heating stages to maintain the leaving air temperature set point. If the unit is equipped with the modulating gas heat control option, then the low load demand signal will continuously modulate the heating load to maintain the leaving air temperature set point. A high demand signal will energize all stages of heat. The gas modulating section will operate at maximum heating capacity if the modulating option is selected.

If the unit has hydronic heat option then the low load demand signal will control the modulating control valve to the configurable low heat load leaving air temperature set point. A high demand signal will cause the modulating control valve to go to a 100% open position.

Unoccupied Mode — If the unit is configured for unoccupied free cooling, mechanical cooling or heating and the temperature goes beyond the unoccupied configuration set points then the control will turn on free cooling, mechanical cooling or heat as needed to get within the unoccupied set points. When in this mode, the economizer dampers will be maintained fully closed or to the minimum unoccupied ventilation set point.

Variable air volume control — On power up, the control module will activate the initialization software. The software will determine the unit configuration and also initialize any controls loops and input/output devices. All alarms and configurations are saved in memory and maintained during power outages. All alarms will be maintained in memory and must be cleared using the display.

The unit will first determine the mode of operation. If the unit has been configured for space temperature demand then the control will determine, based on the configurable set points, if the unit should be in the heating, vent or cooling mode. If the unit is configured for return air temperature control then it will start the fan and monitor the return air temperature vs. the configurable set point to determine if the unit should be in cooling, vent or heating mode. If the control is connected to a ComfortID system, the room terminals are equipped with microprocessor controls that give commands to the base module. If linkage is active, the

Controls (cont)



control module will replace local *ComfortLink* set points and occupancy data with linkage supplied data.

Vent — If temperature compensated start is active then advance pre-cooling or heating of the space is enabled. If the unit is configured to use a pre-purge cycle then the *ComfortLink* controls will start the unit in Vent mode based on a pre-start time interval. If an IAQ sensor is being used and the low IAQ control point is satisfied, then the mode will be terminated.

Cooling — If Cooling mode is required, then the controlling set point will be the leaving air temperature set point. If an economizer is present and the changeover control allows the economizer to be used, then it will first attempt to control the leaving-air temperature using free cooling. If this can not satisfy the load, then additional compressor stages will be turned on to maintain the leaving-air temperature.

When both compressors and economizers are being used, the control will use the economizer dampers to maintain better control of the leaving-air and to help prevent high compressor cycling. If the economizer can not be used then it will be set to the minimum vent position. When using compressors, the leaving-air temperature will sequence compressors on and off using a PID control loop.

If the unit is equipped with an optional hot gas bypass valve the control will use the hot gas as an additional stage of capacity. When the first stage of cooling is required the control will turn on a circuit “A” compressor and the hot gas bypass valve. When additional cooling is called for it will turn off the hot gas bypass valve. The valve will also be used for additional freeze protection of the coils when low evaporator refrigerant temperatures are detected using the suction pressure transducers.

When operating in cooling the control will also monitor the supply duct pressure and send a 4 to 20 mA signal to the factory-supplied inverter to control the speed of the fan and the delivered cfm. If the control is on a linkage system it will also support static pressure reset based on the needs of the zones.

Heating — If the unit has been enabled for occupied heat and the space temperature sensor (SPT), return air temperature sensor (RAT) or linkage demand calls for heat, the control will energize the electric heat or gas heat (if present) to warm the space.

In this mode the control will energize the heat interlock relay which will signal the terminals to open to the heating position. Note that for the linkage systems the interlock relay connection is not required. Once the Heat mode is enabled, the heat capacity will be controlled by the return air temperature set point. Heating will continue until the return temperature set point is satisfied. If the unit is configured for morning warm-up and the heating demand is below the set point during the first 10 minutes of operation, the control will energize full heating capacity until the return air temperature set point is satisfied.

If the space temperature sensor (SPT), return air temperature sensor (RAT) or linkage demand requires that the unit be in heating then the control will energize the electric heat or gas heat (if present) to warm the space. In this mode the control will energize the heat interlock relay which

should be connected to the terminals to indicate that they should open to the heating position. The interlock relay connection is not required for the linkage systems. Heating will continue until the mode selection sensor is satisfied.

Dehumidification mode — A Dehumidification mode can be initiated by either a discrete input on TB202 or by a direct measurement of humidity levels with an optional space or return air humidity sensor. When the Dehumidification mode is active, the evaporator coil leaving air temperature will be controlled to the Dehumidify Cool set point, which is typically colder than the normal cool mode leaving air set points.

In this mode, comfort condition set points, which are based on dry bulb temperature, will be overridden. If a source of reheat is available, then the leaving-air temperature can be raised to a more desirable temperature. Available methods of reheat are internal gas heat (if the unit is equipped with the staged gas heating option), modulating hot water heat (if the unit is equipment with a hydronic coil), or an external heat source that can be controlled by a discrete 24-VAC signal.

Humidi-MiZer® operation — The design of the Humidi-MiZer adaptive dehumidification system allows for two humidity control modes of operation of the rooftop unit, utilizing a common subcooling/reheat dehumidification coil located downstream of the standard evaporator coil.

This unique and innovative design provides the capability for the rooftop unit to operate in both a subcooling mode and a hot gas reheat mode for maximum system flexibility.

The Humidi-MiZer package is factory installed and will operate whenever there is a dehumidification requirement. The Humidi-MiZer system is initiated based on input from a factory-installed return air humidity sensor to the large rooftop unit controller. Additionally, the unit controller may receive an input from a space humidity sensor, a discrete input from a mechanical humidistat, or third-party controller. A unit equipped with a Humidi-MiZer system can operate in the following modes:

Conventional Cooling Mode — Conventional operation of the P Series large rooftop unit allows the unit to cycle up to six compressors to maintain comfort conditions, with expanded cycling operation offered by the optional digital compressor.

This mode is the conventional DX (direct expansion) cooling method used on Carrier’s standard large rooftops and provides equivalent capacity to a non-Humidi-MiZer equipped unit. It is used when there is a call for cooling only, such as at design AHRI (Air-Conditioning, Heating, and Refrigeration Institute) cooling conditions of 95 F ambient and 80 F/67 F db/wb entering air conditions. The SHR (sensible heat ratio) for equipment in this scenario is typically 0.7 or higher.

Subcooling Mode — This mode will operate to satisfy part load type conditions when there is a space call for cooling and dehumidification. Although the temperature (sensible) may have dropped and decreased the sensible load in the space, the outdoor and/or space humidity levels may have risen.

A typical scenario might be when the outside air is 85 F and 70 to 80% relative humidity (RH). Desired SHR for equipment in this scenario is typically 0.4 to 0.7. Carrier’s

P Series Humidi-MiZer adaptive dehumidification system will increase subcooling entering the evaporator and cycle on enough compressors to meet the latent load requirement, while simultaneously adjusting refrigerant flow to the Humidi-MiZer coil to reheat the air to the required supply air set point. This will allow the unit to provide variable SHR to meet space requirements.

Conversely, a standard unit might overcool the space or stage down to meet set point, sacrificing latent capacity control. The Humidi-MiZer unit will initiate subcooling mode when the space temperature and humidity are both above the temperature and humidity set points, and attempt to meet both requirements.

Once the humidity requirement is met, the unit can continue to operate in normal cooling mode to meet any remaining sensible capacity load. Alternatively, if the sensible load is met and humidity levels remain high the unit can switch to Hot Gas Reheat mode to provide neutral, dehumidified air.

Hot Gas Reheat Mode — This mode is used when dehumidification is required without a need for cooling, such as when the outside air is at a neutral temperature (70 to 75 F) but high humidity exists. This situation requires the equipment to operate at a SHR of 0.0 to 0.2.

With no cooling requirement and a call for dehumidification, the P Series Humidi-MiZer adaptive dehumidification system will cycle on enough compressors to meet the latent load requirement, while simultaneously adjusting refrigerant flow to the Humidi-MiZer® coil to reheat the air to the desired neutral air set point.

The P-Series Humid-MiZer system controls allow for the discharge air to be reheated to either the return-air temperature minus a configurable offset or to a configurable Reheat set point (default 70 F). The Hot Gas Reheat mode will be initiated when only the humidity is above the humidity set point, without a demand for cooling.

Mode Control — The essential difference between the Subcooling mode and the Hot Gas Reheat mode is in the supply air set point. In Subcooling mode, the supply air set point is the temperature required to provide cooling to the space. In Reheat mode, the supply air set point is the temperature required to provide neutral air to the space. In both cases, the unit will decrease the evaporator discharge temperature to meet the latent load and reheat the air to the required cooling or reheat set point (i.e., 50, 60, 70 F, etc.).

48 Series gas heat units

The gas heat units incorporate 1, 2 or 3 separate systems, depending on unit size and heating capacity, to provide gas heat. Each system incorporates its own induced-draft motor, integrated gas control (IGC) board, 2-stage gas valve, manifold, and safeties. The modulating system incorporates an additional modulating gas valve and modulating gas control. For 2-stage heat control the systems are operated in parallel. For example, when there is a call for first stage heat, both induced-draft motors operate, both gas valves are energized, and both IGC boards initiate spark. With the staged and modulating gas control, the systems are operated independently to allow for a greater range of capacity control. All of the gas heating control is performed through the IGC

boards (located in the heating section). There are two additional boards (TR1 and SC30) for the modulating system, which in combination with the IGC board control the modulating gas heating. The additional boards are located in the heating section. The MBB module board serves only to initiate and terminate heating operation and monitor the status of the requirements for indoor fan operation. The fan will be controlled directly by the MBB board. The base module board is powered by 24 vac.

When the thermostat or room sensor calls for heating the MBB board will close heating relays and send power to W on each of the IGC boards. An LED on the IGC board will be on during normal operation. A check is made to ensure that the rollout switches and limit switches are closed and the induced-draft motors are not running. After the induced-draft motors are energized and speed is proven with the Hall Effect sensor on the motor. For units equipped with modulating gas heat the induced-draft motor function is proven with a pressure switch. When the motor speed or function is proven, the ignition activation period begins. The burners will ignite within 5 seconds. When ignition occurs the IGC board will continue to monitor the condition of the rollout and limit switches, the flame sensor, the Hall Effect sensor or pressure switch.

If the unit is controlled through a room thermostat set for fan auto., 45 seconds after ignition occurs the indoor-fan motor will be energized and the outdoor-air dampers will open to their minimum position. If the over temperature limit opens prior to the start of the indoor fan blower, on the next attempt the 45-second delay will be shortened to 5 seconds less than the time from initiation of heat to when the limit tripped. Gas will not be interrupted to the burners and heating will continue. Once modified, the fan on delay will not change back to 45 seconds unless power is reset to the control. If the unit is controlled through a room sensor, the indoor fan will be operating in the occupied mode and the outdoor-air dampers will be in the minimum position.

If the unit is controlled with a room sensor in the unoccupied mode, the indoor fan will be energized through the IGC board with a 45-second delay and the outside-air dampers will move to the minimum unoccupied set point.

When additional heat is required, the second stage MBB output relay closes and initiates power to the second stage of all main gas valves in all sections. For units equipped with modulating system, the second stage is controlled by the TR1 timer relay board. When the demand is satisfied, MBB heat output relays will open and the gas valves close interrupting the flow of gas to the main burners. If the call for stage 1 heat lasts less than 1 minute, the heating cycle will not terminate until 1 minute after W1 became active. If the unit is configured for intermittent fan then the indoor-fan motor will continue to operate for an additional 45 seconds then stop and the outdoor-air dampers will close. If the over temperature limit opens after the indoor motor is stopped within 10 minutes of W1 becoming inactive, on the next cycle the time will be extended by 15 seconds. The maximum delay is 3 minutes.

Once modified, the fan off delay will not change back to 45 seconds unless power is reset to the control.

Application data



Field connections

Ductwork — Secure vertical discharge ductwork to roof curb. Interior installation may proceed before unit is set in place on roof. For horizontal discharge applications, attach ductwork to unit via 1.25 in. factory installed lip, or field-supplied flanges can be attached to horizontal discharge openings and all ductwork attached to flanges. Units equipped with electric heat require a 90-degree elbow below the unit supply duct connection.

Thru-the-curb service connections — Roof curb connections allow field power wires and control wires to enter through the roof curb opening.

Thermostat (CV/SAV only) — Use of a thermistor-type room sensor is recommended on all CCN installations. A thermistor-type room sensor or a 2-stage heating/cooling thermostat may be used for all other units.

Heating-to-cooling changeover — All units are automatic changeover from heating to cooling when automatic changeover thermostat and subbase or a thermistor-type room sensor are used.

Airflow

Airflow — Units are draw-thru on cooling and blow-thru on heating.

Motor HP considerations — Due to Carrier's internal unit design (draw-thru over the motor), exposure to a conditioned air path, and specially designed motors, the full horsepower listed in the Physical Data table and Motor Limitations tables on pages 139 and 140 can be utilized with extreme confidence. Using Carrier motors with the values listed in the Physical Data and Motor Limitations tables will not result in nuisance tripping or premature motor failure. The unit warranty will not be affected.

Maximum airflow — To minimize the possibility of condensate blow-off from evaporator, airflow through units should not exceed values shown in the Unit Design Airflow Limits table on page 7 and Cooling Capacities tables.

Minimum airflow — The minimum airflow for cooling is 300 cfm/ton for constant volume units and 70 cfm/ton for VAV (variable air volume) units. Performance at 70 cfm/ton is limited to unloaded operation and may be additionally limited by entering-air temperatures and Humidi-MiZer operation. Refer to Gas Heating Capacities tables on pages 7-12 for minimum airflow cfm for heating.

Ambient cooling temperatures

Minimum ambient cooling operation temperature — All units are equipped with factory economizers to allow free cooling at any outdoor ambient. If mechanical cooling is required, the units are designed to operate at outdoor temperatures down to 32 F. With accessory Motormaster® V control units can operate at outdoor

temperatures down to -20 F. Outdoor-fan motor change out may be required for Motormaster V applications.

Carrier recommends the installation of field-fabricated wind baffles on all vertically oriented condenser coil surfaces when operating in environments with prevailing winds of more than 5 mph and where temperatures drop below 32 F.

Maximum operating outdoor-air temperature

— The maximum operating outdoor-air temperature is 115 F. Some models will operate up to 125 F depending on model and operating conditions.

Heating

High altitude (gas heat units only) — A change to the gas orifice may be required at high altitudes. Contact Carrier Application Engineering.

Minimum temperature — Minimum allowable temperature of mixed air entering the heat exchanger during half rate (first stage) operation is 50 F. There is no minimum mixture temperature during full-rate operation. Comfort conditioning may be compromised at temperatures below 50 F. Below 50 F entering-air temperature (EAT) both stages of heat are engaged.

Electric heat — A field-supplied 90-degree elbow must be installed in the supply ductwork below the unit discharge.

Auxiliary coil

Auxiliary coil — The 48/50P units with extended chassis are capable of accepting field-supplied and installed auxiliary coils (typically hydronic heating, steam heating, or refrigeration heat reclaim coils). These units include coil tracks and face framing to facilitate installation of auxiliary coils. See the figure on next page for dimensions on coil tract locations inside these units. See the Auxiliary Coil Frame Dimension table for dimensions for the auxiliary coil.

AUXILIARY COIL FRAME DIMENSIONS (in.)

UNIT SIZE 48/50P	030-050	055-100
Casing Depth	9.80	9.80
Casing Height	55.52	66.00
Casing Length*	69.50	69.50
Overall Length†	83.90	83.90

*Longer casing lengths possible but modifications to face framing sheet metal will be required during installation.

†Represents the maximum overall length of the coil plus all piping and coil control devices located inside the air handler cabinet.

Application of hydronic coils and steam heating coils in outdoor located equipment should always be considered very carefully. Design such systems for low temperature protection in the event of power failure to the unit.

Steam coils are typically not recommended for installation in outdoor located equipment, due to added space required for fluid control and need to protect all piping and controls

in the event of power failure to the building and/or the unit. Consider installing small steam-to-hydronic heat exchangers with circulating pump to deliver hydronic fluids out to the auxiliary coil in the air conditioner unit.

Acoustics

Acoustical considerations — In order to minimize sound transmitted to the space, please follow these recommendations:

Location

- Avoid locating the unit above sound sensitive areas. Instead, locate the unit above rest rooms, storage areas, corridors, or other noise tolerant areas.
- Avoid mounting the unit in the middle of large roof expanses between vertical supports. This will minimize the phenomenon known as roof bounce.
- Install the units close to vertical roof supports (columns or load bearing walls).
- Locate the units at least 25 ft away from critical areas. If this is not possible, the ductwork and ceiling structure should be acoustically treated.
- Consider the use of vibration isolators or an acoustic curb.

Ductwork

- Use flexible connectors between the unit and the supply and return ducts.
- Supply and return air main trunk ducts should be located over hallways and/or public areas.

- Provide trailing edge turning vanes in ductwork elbows and tees to reduce air turbulence.
- Make the ductwork as stiff as possible.
- Use round duct wherever possible because it is less noisy.
- Seal all penetrations around ductwork entering the space.
- Make sure that ceiling and wall contractors do not attach hangers or supports to ductwork.
- Provide as smooth and gradual transition as possible when connecting the rooftop unit discharge to the supply duct.
- If a ceiling plenum return is used, provide a return elbow or tee to eliminate line-of-sight noise to the space. Face the entrance of the return duct away from other adjacent units.

Acoustic insulation

- Provide acoustic interior lining for first 20 ft of supply and return duct or until the first elbow is encountered. The elbow prevents line-of-sight transmission in the supply and return ducts.
- Install a double layer of 2-in. low density quilted fiberglass acoustical pad with a 1/8-in. barium-loaded vinyl facing on top of the roof deck before building insulation and roofing installation occur. Place the material inside the curb and for 4 to 8 ft beyond the unit perimeter, dependent upon unit size (larger units require a wider apron outside the curb). Openings in the pad should only be large enough for the supply and return ducts. An alternate approach is to use two layers of gypsum board with staggered seams in addition to the acoustical pad.

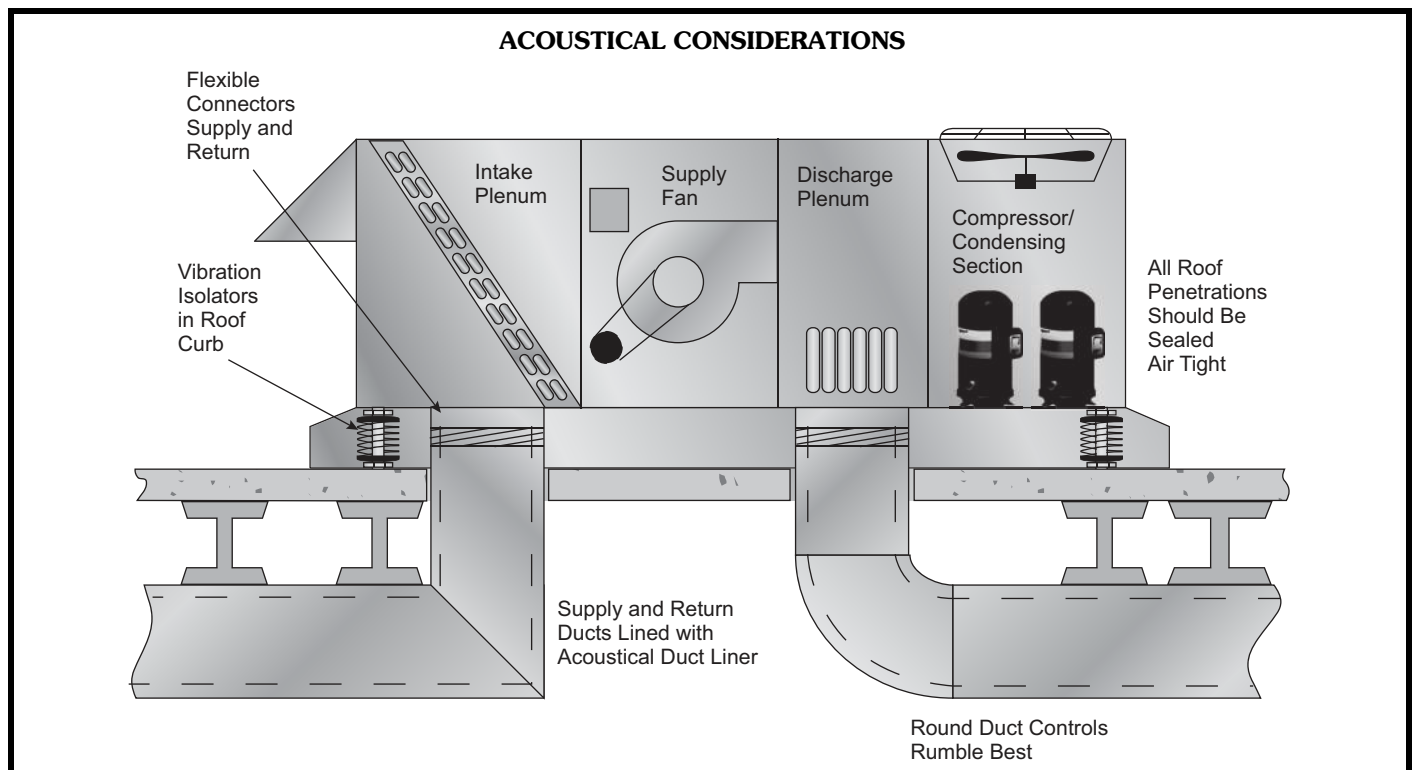

Application data (cont)



Humidi-Mizer system

Humidi-MiZer® system data — The pages of Performance Data include performance tables for Humidi-MiZer equipped units. The tables include capacity in normal cooling, subcooling mode and hot gas reheat mode.

For hot gas reheat performance, the ambient outdoor air and return air temperature ranges are different from the ranges listed for normal design cooling and subcooling rooftop operation. This is to provide appropriate performance data for those conditions when the rooftop unit would most likely respond to provide all latent capacity removal from the space.

All performance data are provided in terms of gross capacities. Combined, the subcooling and reheat tables provide the endpoints of performance potential for each unit

at specific conditions. In reality, the P Series Humidi-MiZer equipped unit will modulate refrigerant bypass flow to ensure that it meets the supply air set point while maintaining low evaporator temperatures needed for maximum moisture removal. This means that the unit sensible capacity varies between the two tables, depending on the load in the space.

The chart below graphically demonstrates this capability. Note that latent capacity stays fairly constant between Subcooling mode and Hot Gas Reheat mode, while sensible capacity varies almost infinitely between the two endpoints of the table. This clearly demonstrates how accurate space temperature and humidity control can be maintained through the P Series innovative modulating refrigerant flow Humidi-MiZer application.

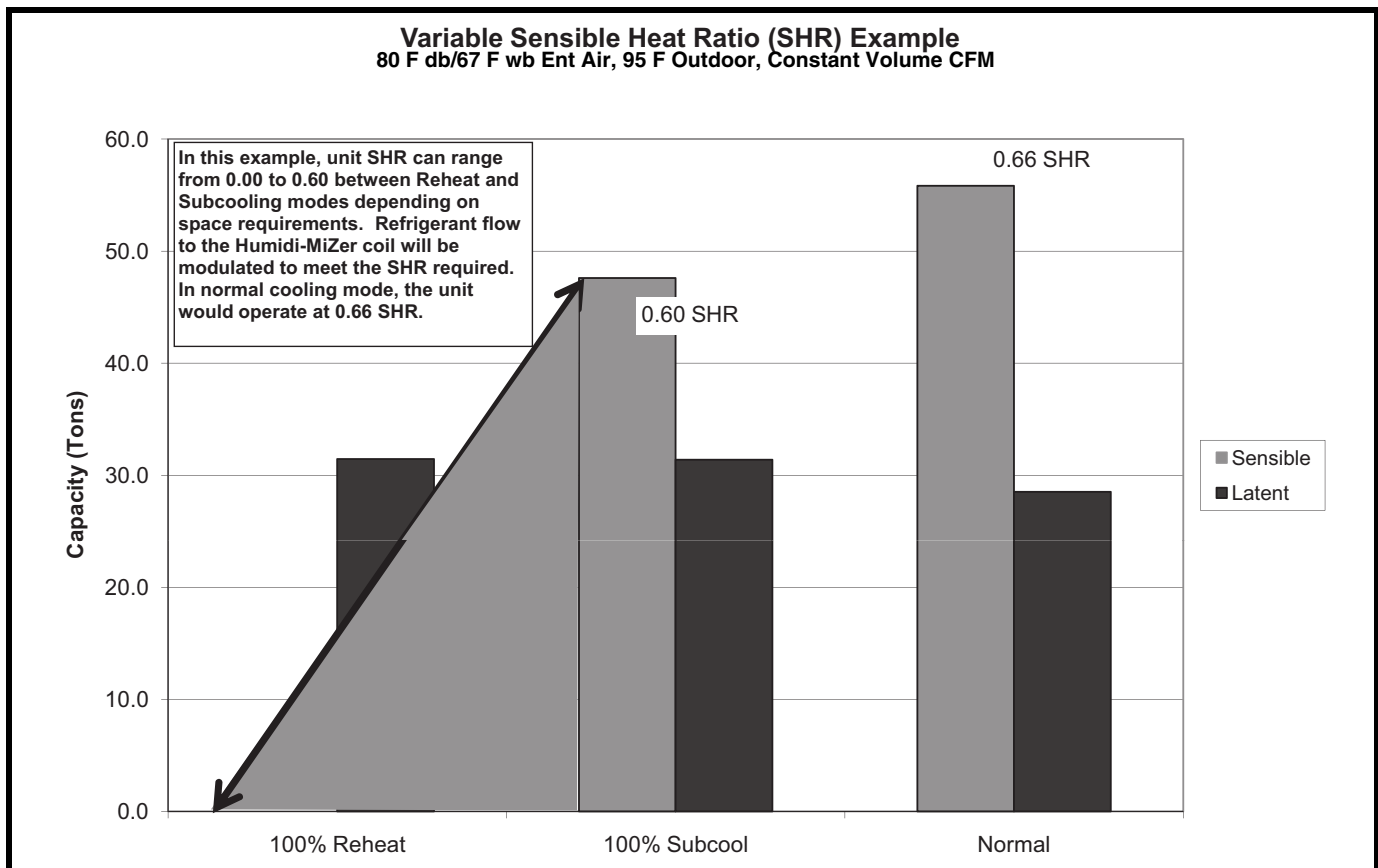

Configurations

Horizontal configurations — The 48/50P Series units can be factory provided with horizontal supply and horizontal return as a standard factory configuration. In the event combinations of vertical and horizontal supply/return openings are required, Carrier can selectively offer these combinations via the special order process. These situations are less common, but may require vertical supply and horizontal return, or horizontal supply and vertical return.

If a unique solution is required, custom roof curbs are available to conduct airflow configuration changes. In these situations, it is prudent to ensure the additional external static pressure (due to the custom roof curb) is incorporated

into the unit selection process. These additional external static pressures are provided by the curb manufacturer.

The horizontal supply units incorporate a discharge plenum to minimize acoustic concerns and avoid abrupt airflow directional changes. The end return design maximizes return opening surface area, while minimizing additional pressure drop. Any additional pressure drop is already incorporated into the Carrier fan tables/curves. Each duct opening provides a 1¹/₄ in. lip to facilitate field duct connections.

Utilize the following simple sketches for horizontal configurations (specific dimensions are available via certified drawings or through your local Carrier sales office).

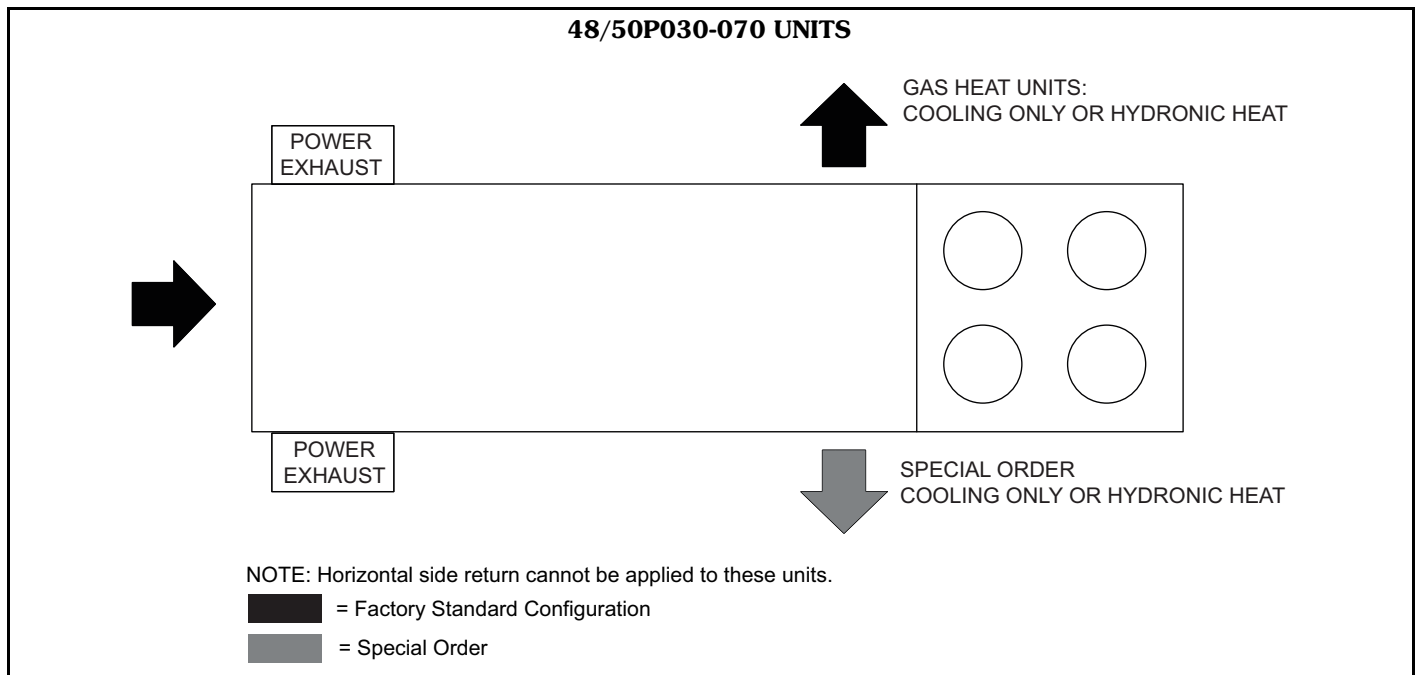

Application data (cont)

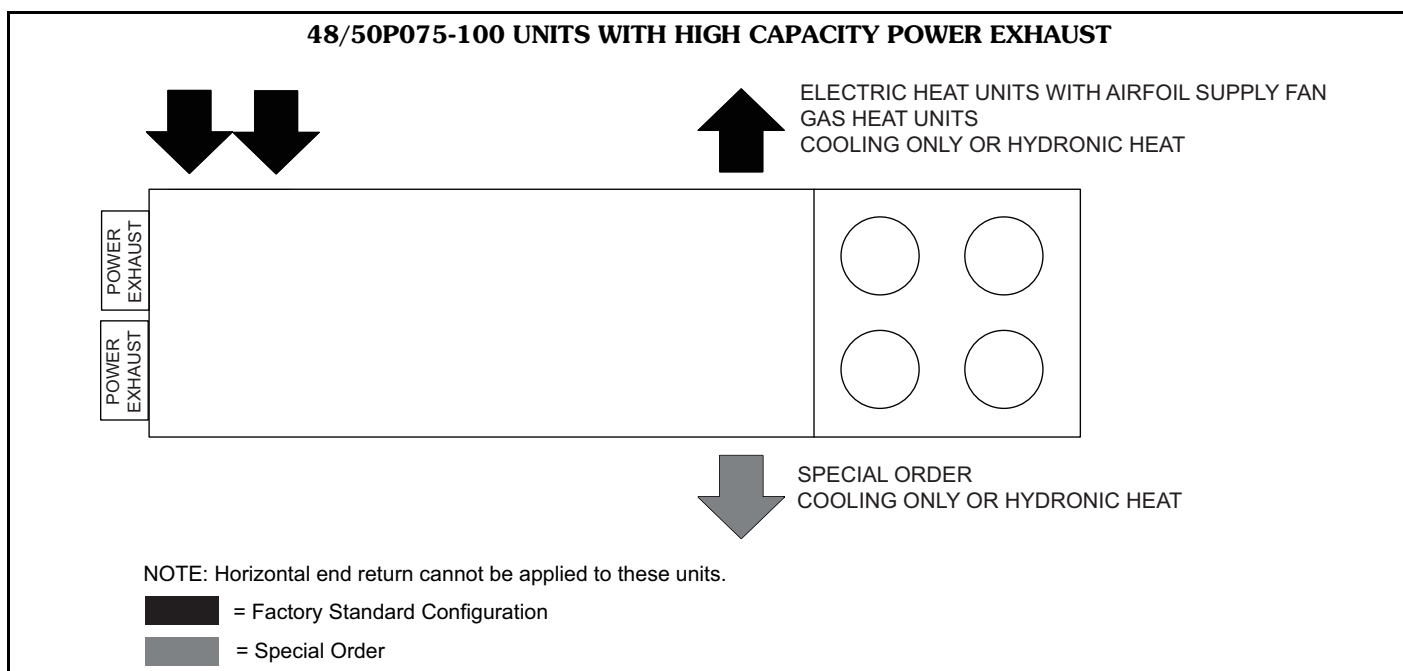
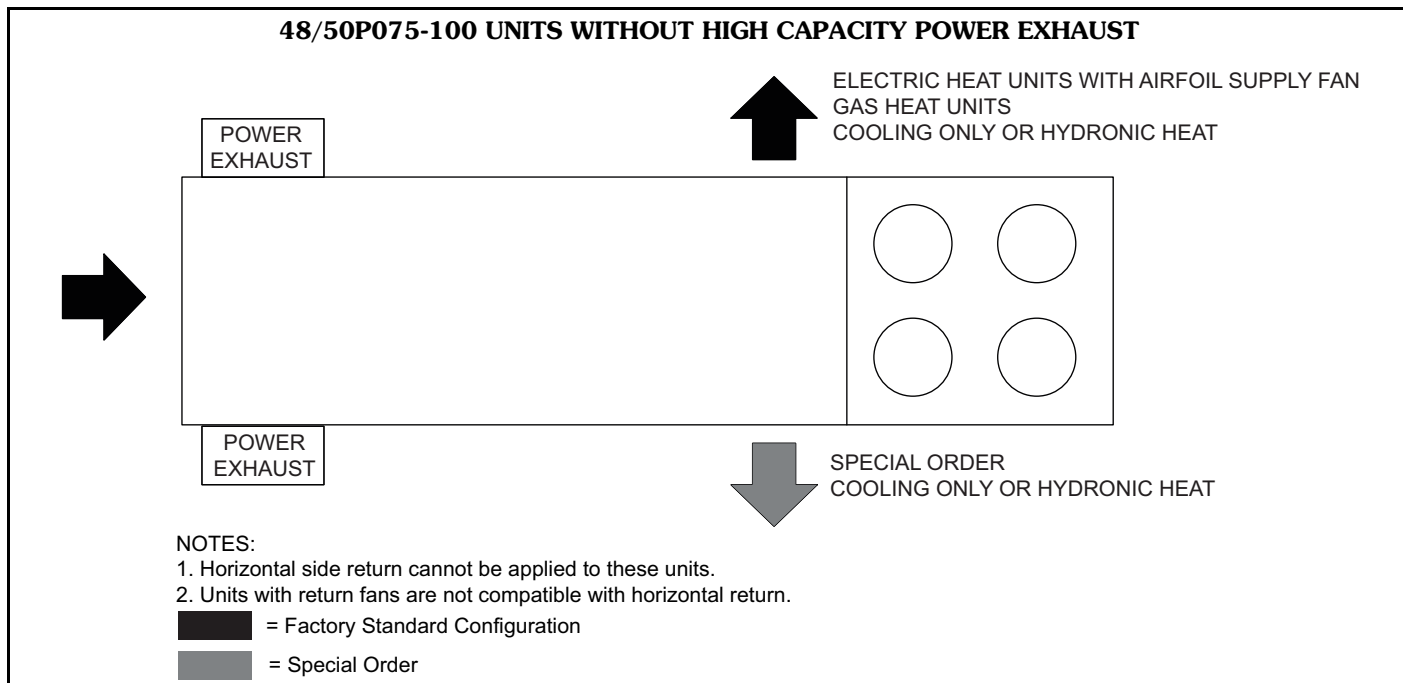

Slab/steel frame mounting — Ordinarily, rooftop units are mounted on roof curbs that provide unit support and allow for easy duct connections. When units are applied on horizontal supply/return configurations, alternatives to roof curbs mounting can be easily explored. Additionally, these alternatives may be beneficial to minimize roof penetrations, maximize roof real estate flexibility, or reduce acoustic concerns.

Two alternatives include concrete slab mounting and steel beam mounting:

Concrete slab mounting — This solution provides flexibility for buildings that do not have structural roof support to handle packaged equipment, or simply to provide improved application flexibility. In addition, slab mounting provides for grade level access of equipment.

When mounting on a concrete pad, Carrier recommends a level slab that is 8 in. thick and at least 4 in. above

grade. To ensure sufficient space for unit placement, it is also recommended the slab extend 6 in. beyond the cabinet. To prevent IAQ impact, use a gravel apron in near the economizer air inlets to minimize grass and foliage byproducts from entering the building. This concept should also be utilized near the condenser coil to maintain unit efficiency and prevent condenser airflow obstructions.

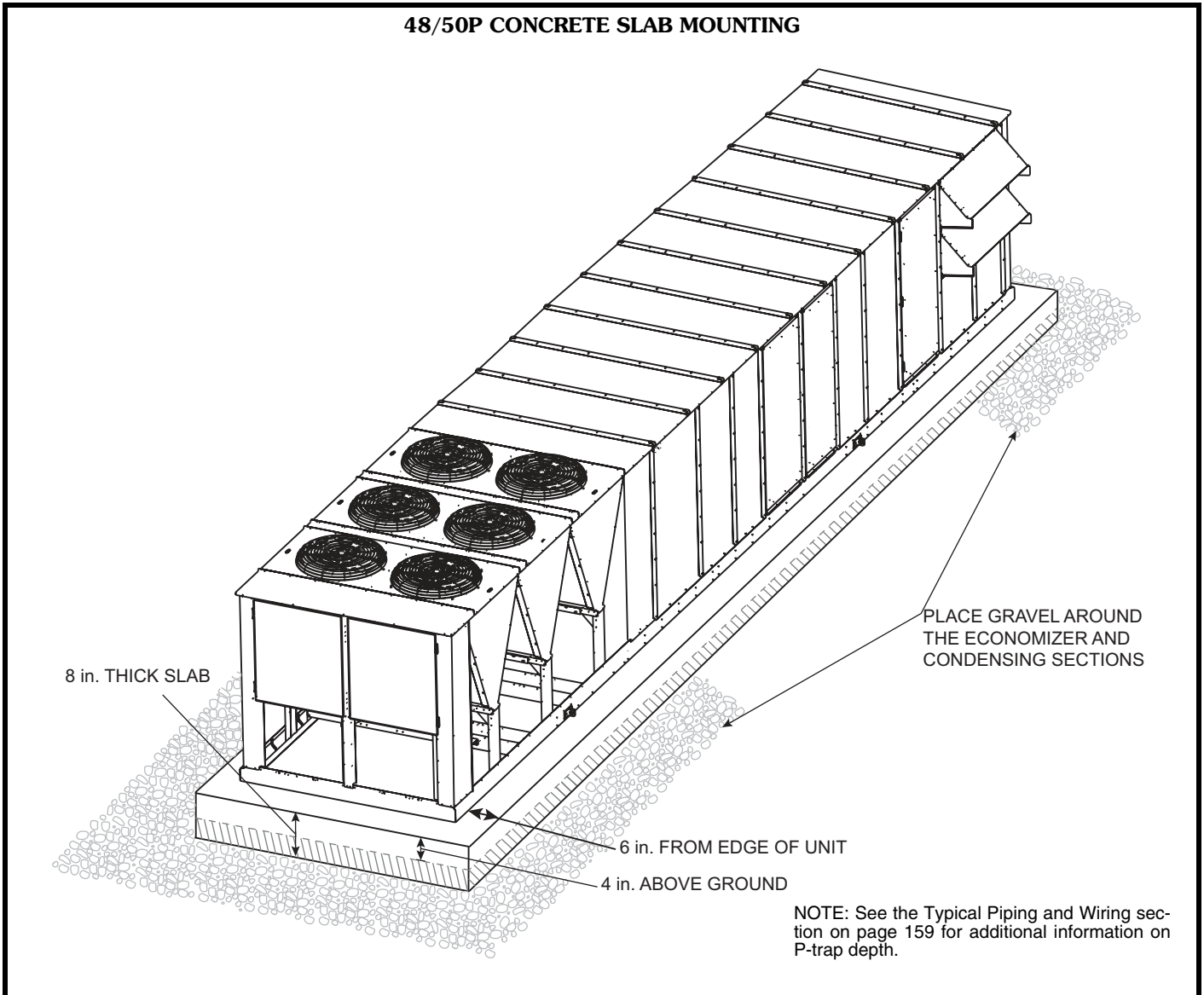

Application data (cont)



Steel beam mounting — To offer additional flexibility for roof or grade level mounting, Carrier accepts mounting units on steel beams. This mounting style is commonly used to aid in vibration/acoustic isolation, minimize roof penetrations, or expand use of roof real estate.

To protect unit insulation on bottom, it is recommended for units to include “Double Wall on-the-bottom” special order. This special order will deliver a double wall floor design and encase the standard insulation in galvanized sheet metal.

NOTE: Double wall on bottom is not compatible with roof curbs.

Carrier requires structural I-beam style-supports along the entire length of a unit. Additionally, to aid in maintaining dimensions of the rails and providing increased weight distribution, Carrier prefers 2 end-cross rails, and intermediate cross rails evenly spaced every 6 to 8 ft.

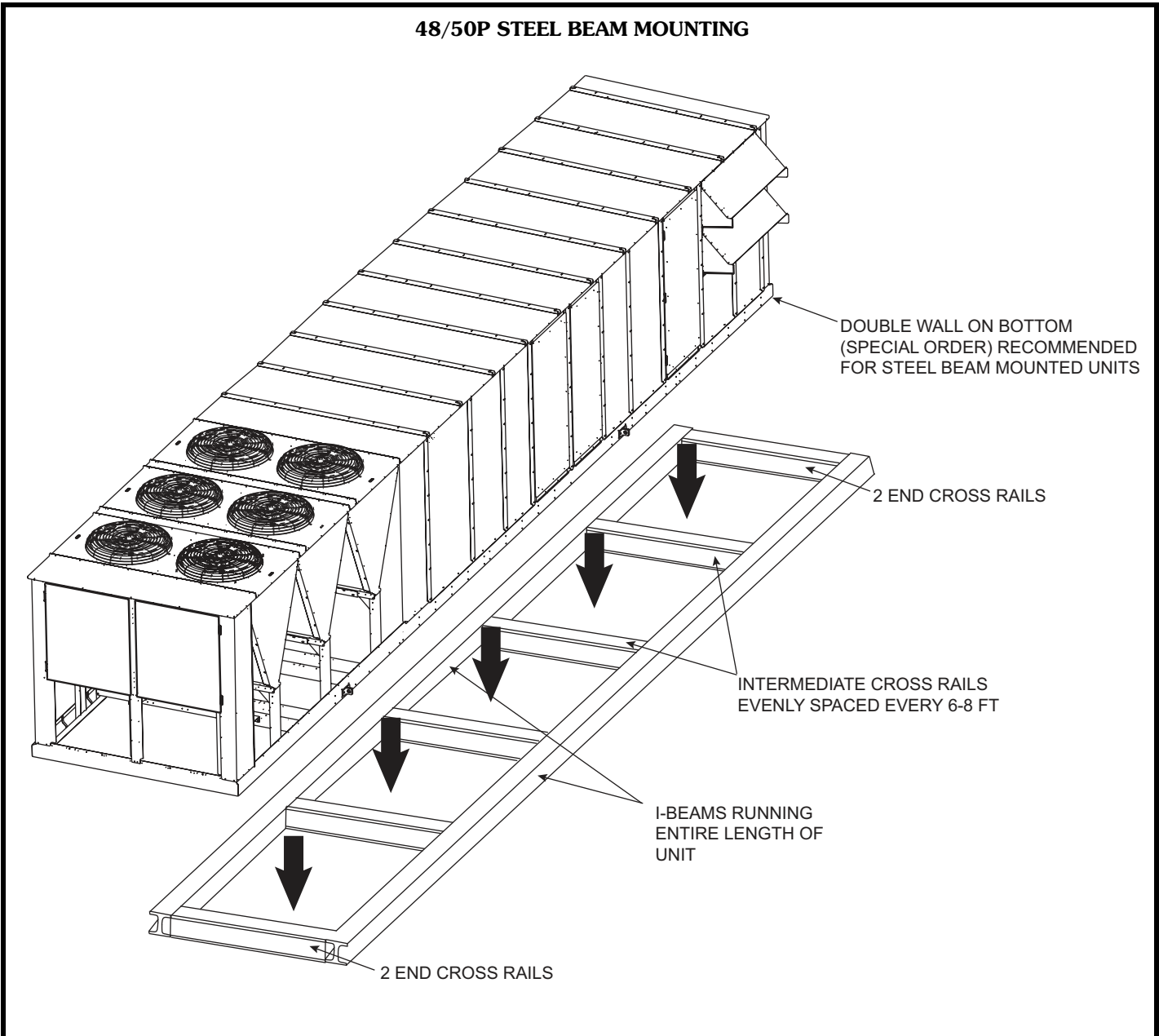

48/50P MULTIPLE UNIT MINIMUM SEPARATION

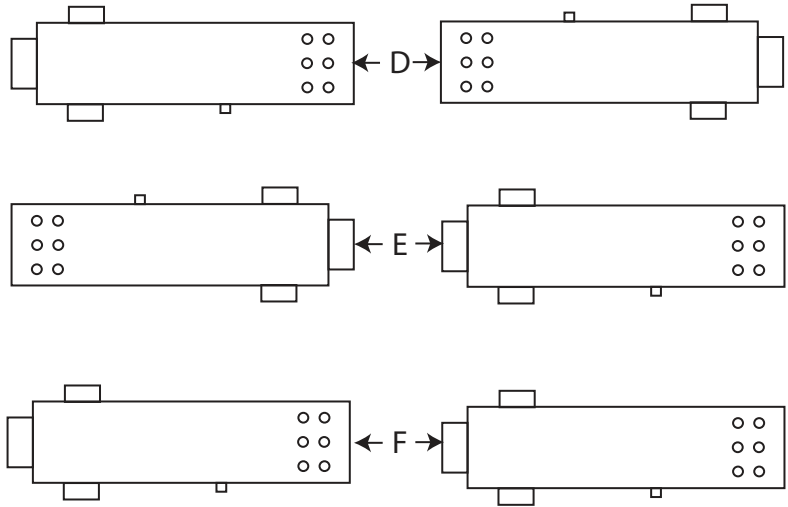
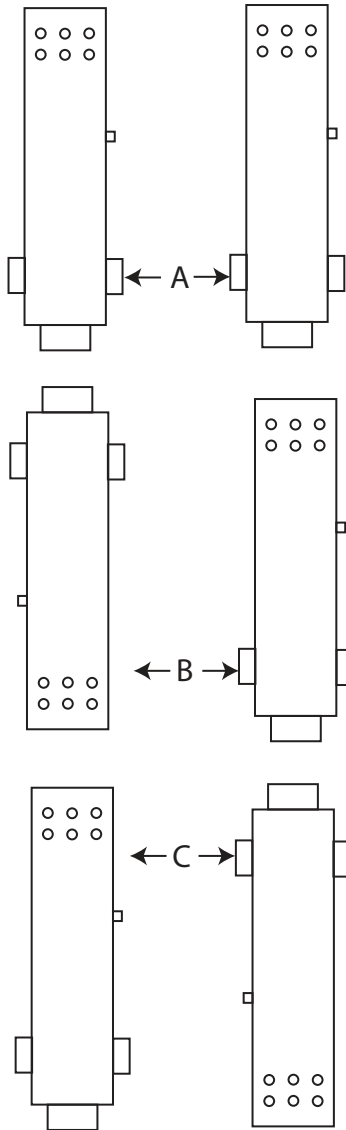

MINIMUM SPACING (ft)

UNIT	A	B	C	D	E	F
48P Series	10	6	8	8	10	8
50P Series	10	6	6	8	10	8

48/50P DIMENSION OF COIL TRACT LOCATIONS INSIDE UNITS

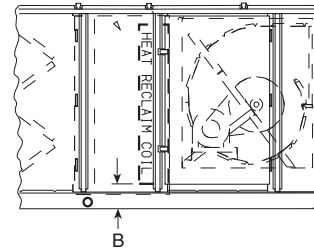
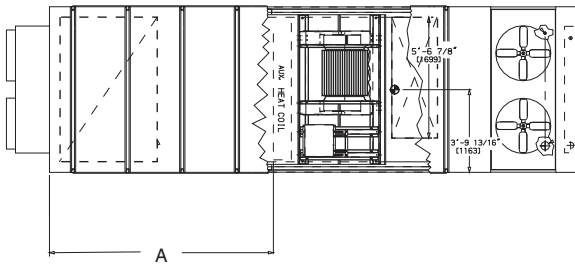

AUXILIARY COIL LOCATION — in.

UNIT SIZES 48/50P	DISTANCE A	HEIGHT B
030,035	123.0	6.6
040,050	156.8	6.6
055-070	200.4	6.6
075-100	200.4	6.6
075-100 with High-Capacity Power Exhaust	279.2	6.6

Typical piping and wiring



STANDARD UNITS (48P2100 SHOWN)

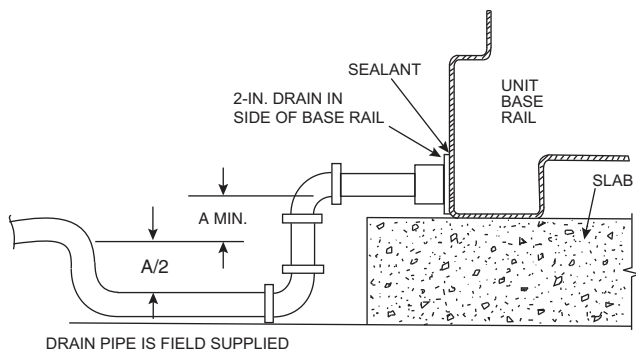
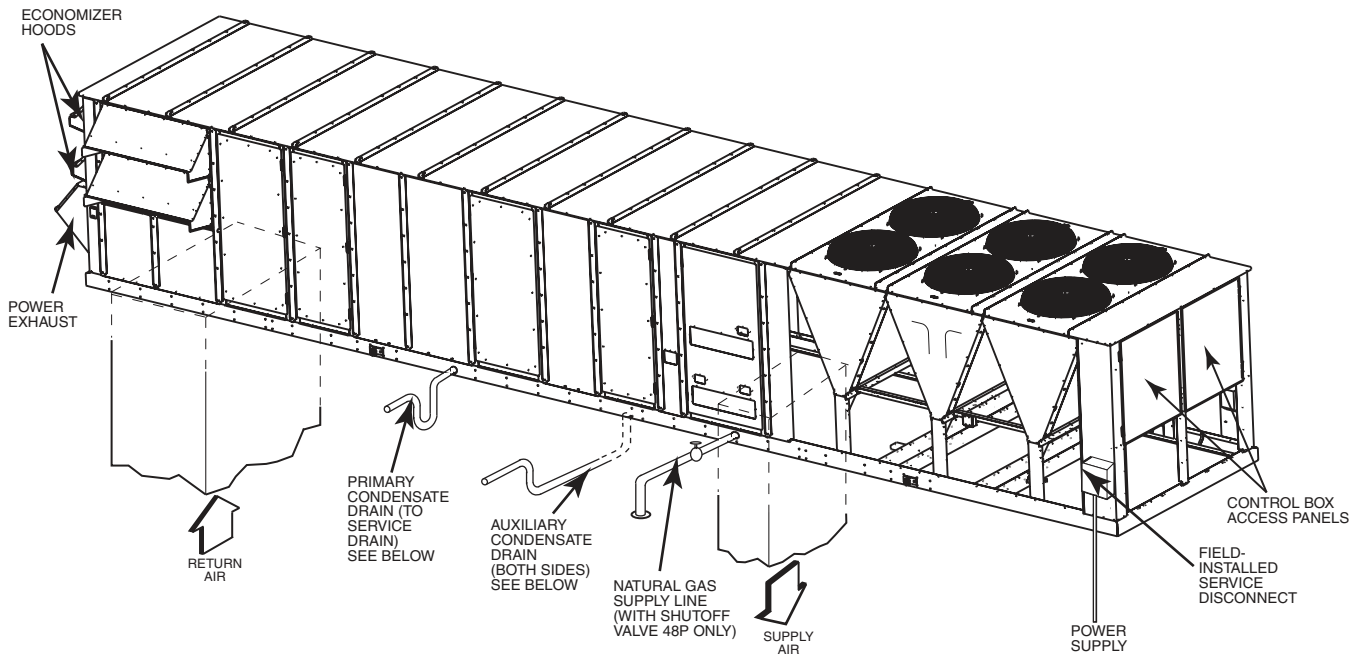

A = 4-in. (102 mm) min — Sizes 030-070
 7-in. (178 mm) min — Sizes 075-100

**Primary Condensate Drain Piping Details
 (Slab and Curb Mounted) and
 Secondary Condensate
 Drain Piping Details (Slab-Mounted)**

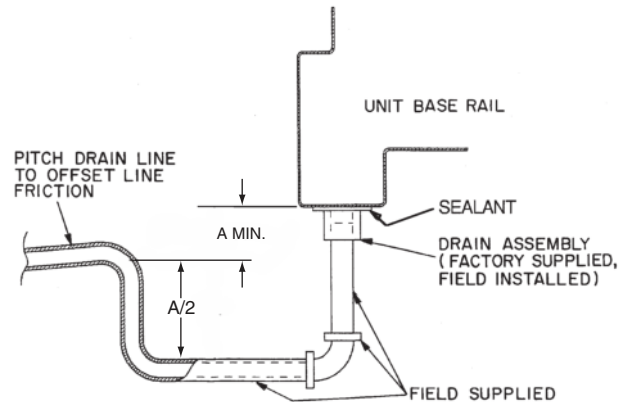

A = 4-in. (102 mm) min — sizes 030-070
 7-in. (178 mm) min — sizes 075-100

**Auxiliary Condensate
 Drain Pipe Details (Curb-Mounted)**

POWER SCHEMATIC — SIZES 040-075 SHOWN

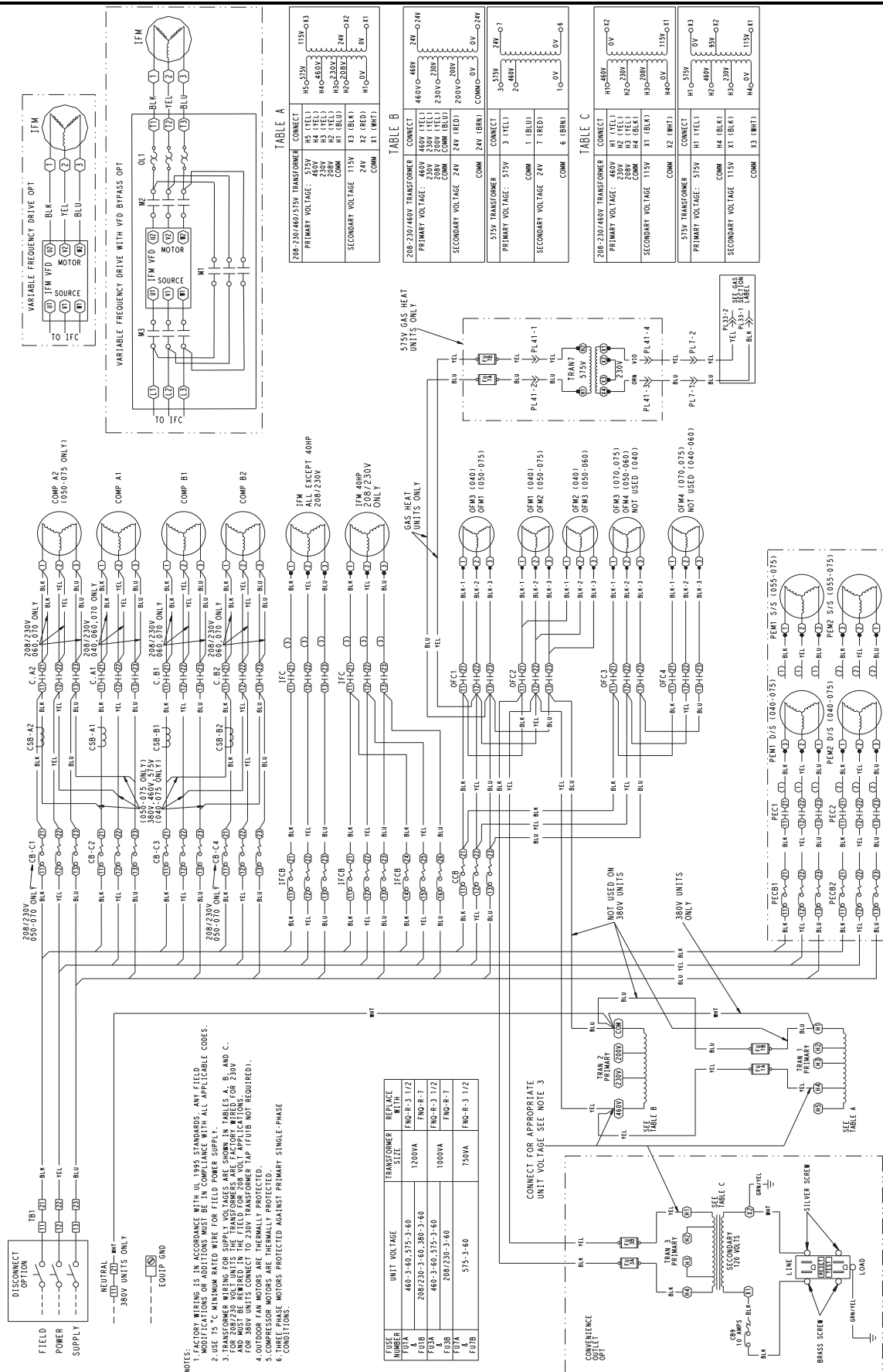

- NOTES:
1. WIRING SHALL BE IN ACCORDANCE WITH ALL LOCAL STANDARDS AND FIELD MODIFICATIONS OR ADDITIONS MUST BE IN COMPLIANCE WITH ALL APPLICABLE CODES.
 2. USE 75 °C MINIMUM RATED WIRE FOR FIELD POWER SUPPLY.
 3. TRANSFORMER WIRING FOR SUPPLY VOLTAGES ARE SHOWN IN TABLES A, B, AND C. AND MUST BE REFERRED TO THE FIELD FOR 208 VOLT APPLICATIONS FOR 380V UNITS CONNECT TO 230V TRANSFORMER TAP (FUB NOT REQUIRED).
 4. OUTDOOR FAN MOTORS ARE THERMALLY PROTECTED.
 5. FAN MOTORS ARE THERMALLY PROTECTED.
 6. THREE PHASE MOTORS PROTECTED AGAINST PRIMARY SINGLE-PHASE CONDITIONS.

FUSE NUMBER	UNIT VOLTAGE	TRANSFORMER SIZE	REPLACE WITH
F1A	460-3-60, 575-3-60	FND-R-3 1/2	
F1B	208/230-3-60, 380-3-60	FND-R-7	
F1C	460-3-60, 575-3-60	FND-R-3 1/2	
F1D	208/230-3-60	FND-R-7	
F1E	575-3-60	FND-R-3 1/2	

TABLE A

208-230/460/575V TRANSFORMER	CONNECT
PRIMARY VOLTAGE: 460V	H4 (YEL)
230V	H3 (YEL)
COM	H1 (BLU)
SECONDARY VOLTAGE: 115V	X3 (BLK)
24V	X2 (RED)
COM	X1 (WHT)

TABLE B

208-230/460V TRANSFORMER	CONNECT
PRIMARY VOLTAGE: 460V	H4 (YEL)
230V	H3 (YEL)
COM	COM (BLU)
SECONDARY VOLTAGE: 24V	Z4V (RED)
COM	COM (BLU)

TABLE C

208-230/460V TRANSFORMER	CONNECT
PRIMARY VOLTAGE: 460V	H1 (YEL)
230V	H2 (YEL)
COM	H4 (BLK)
SECONDARY VOLTAGE: 115V	X1 (BLK)
COM	X2 (WHT)

TABLE D

575V TRANSFORMER	CONNECT
PRIMARY VOLTAGE: 575V	3 (YEL)
COM	1 (BLU)
SECONDARY VOLTAGE: 24V	7 (RED)
COM	6 (BRN)

TABLE E

575V TRANSFORMER	CONNECT
PRIMARY VOLTAGE: 575V	H1 (YEL)
COM	H4 (BLK)
SECONDARY VOLTAGE: 115V	X1 (BLK)
COM	X3 (WHT)

INPUT/OUTPUT DIAGRAM — MAIN BASE BOARD

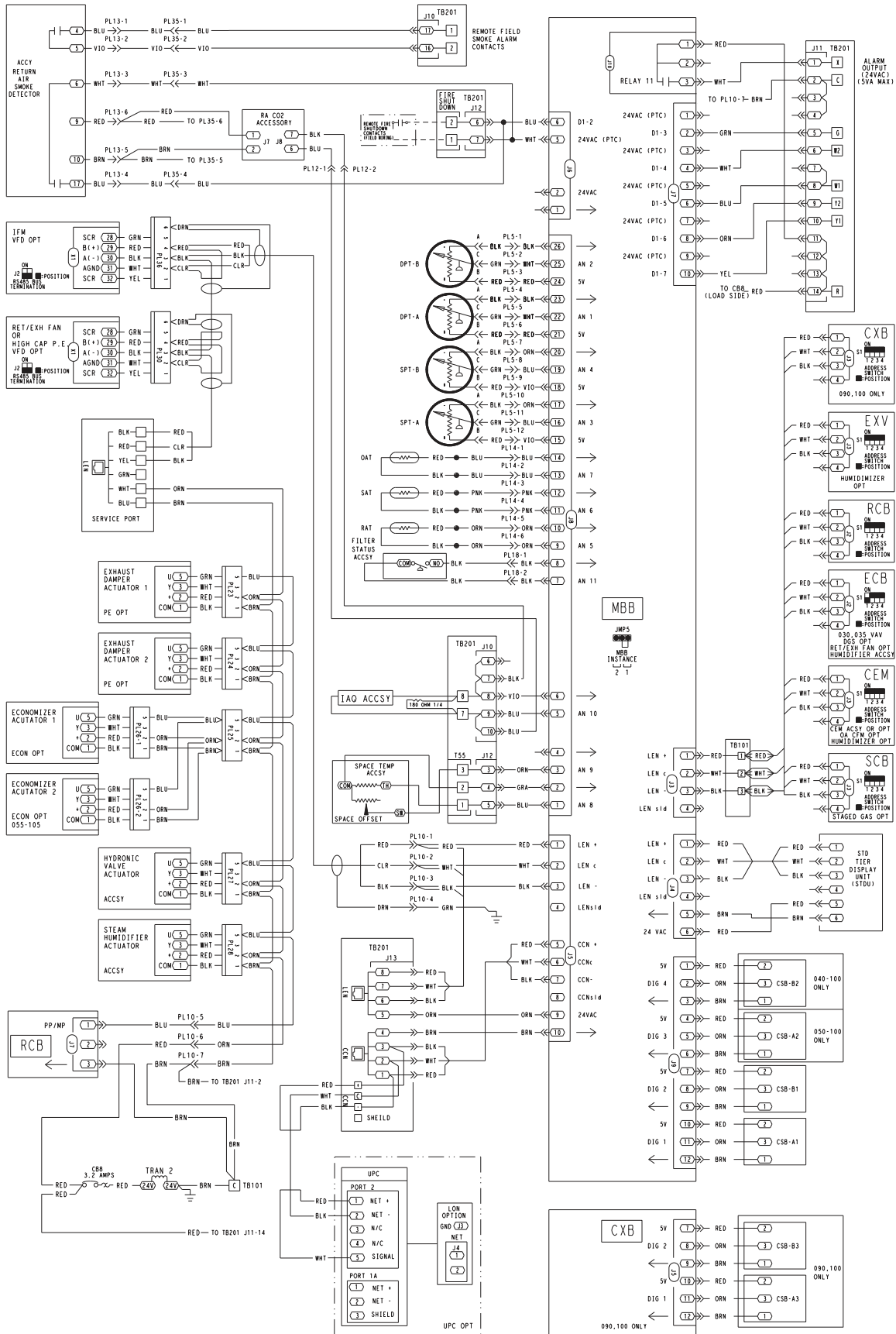

Typical wiring schematics (cont)

INPUT/OUTPUT DIAGRAM — RXB, EXB, CEM, SCB

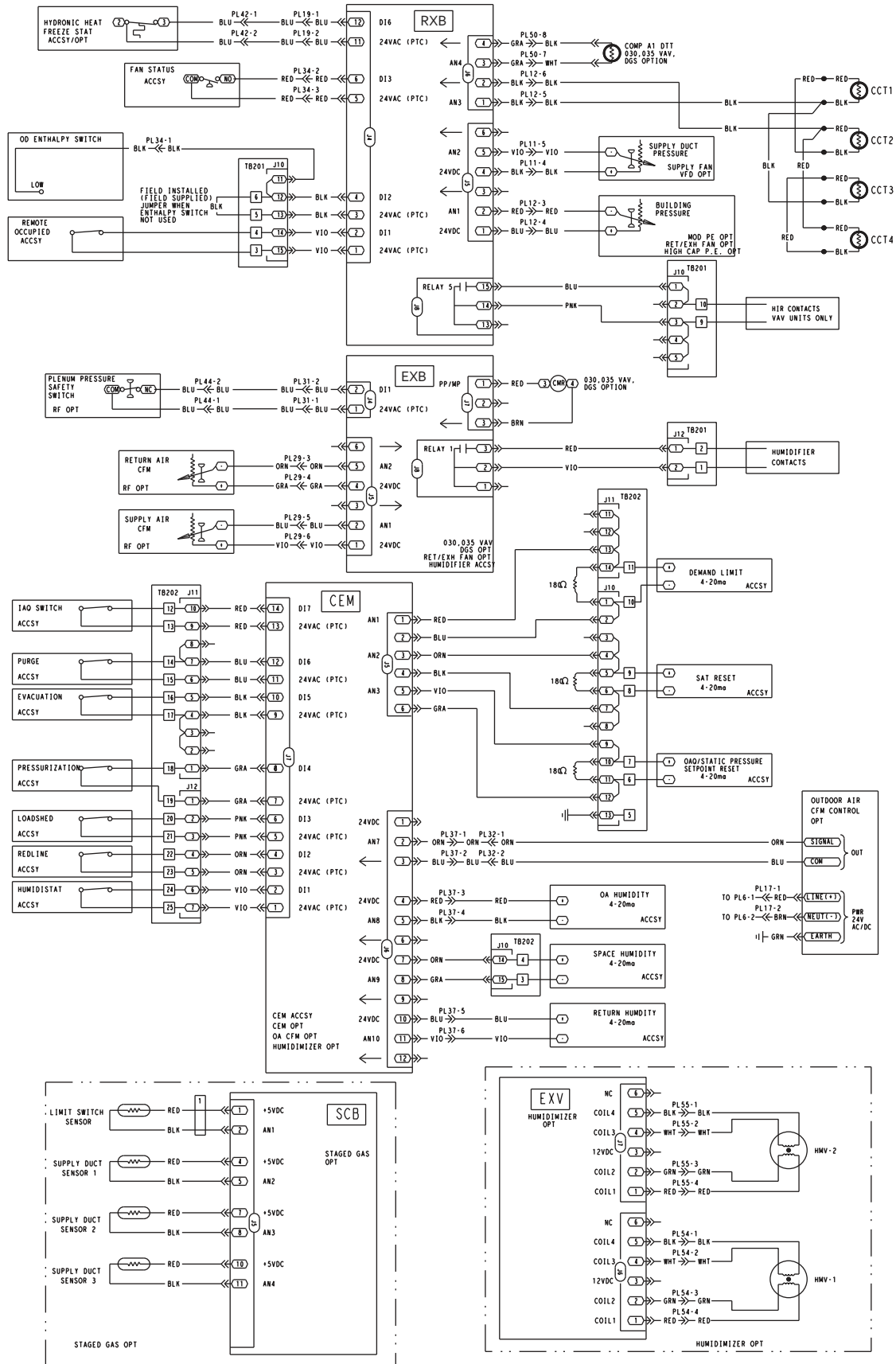

CONTROL SECTION — 48P2,P3,P4,P5 UNITS

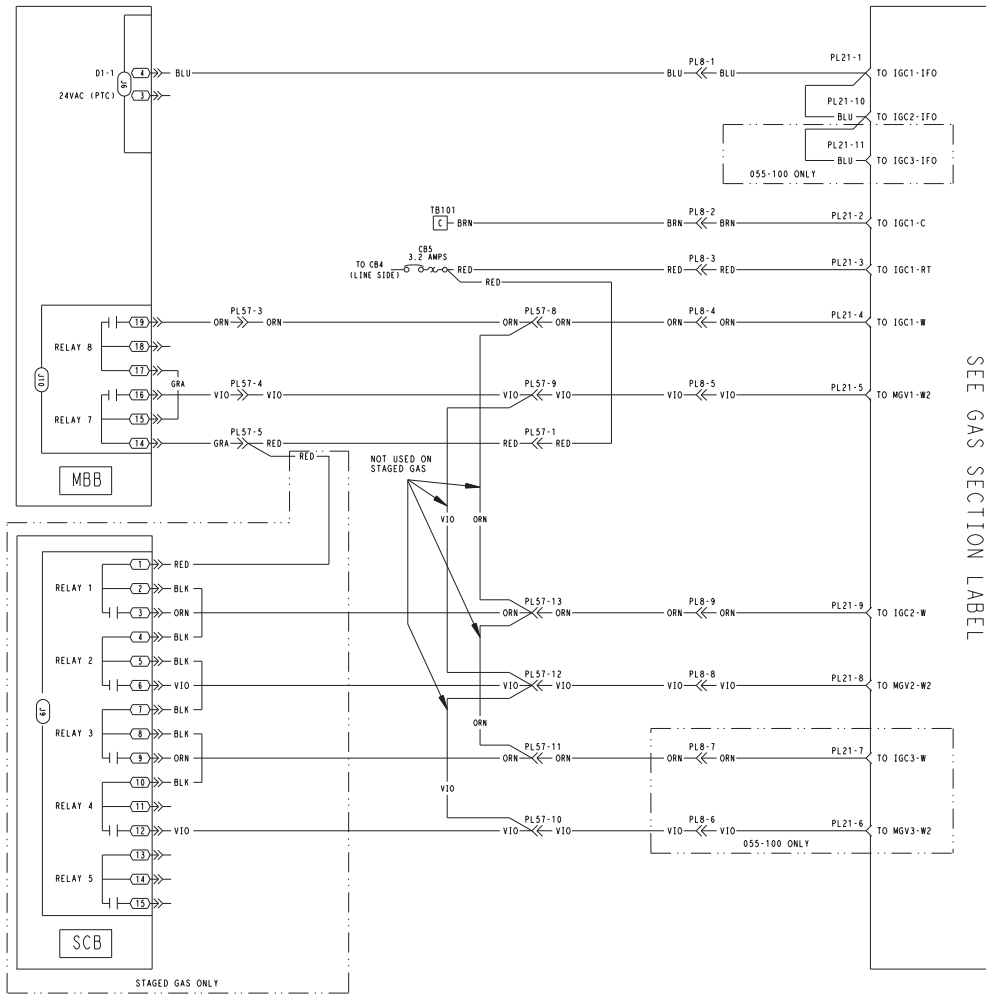

SEE GAS SECTION LABEL

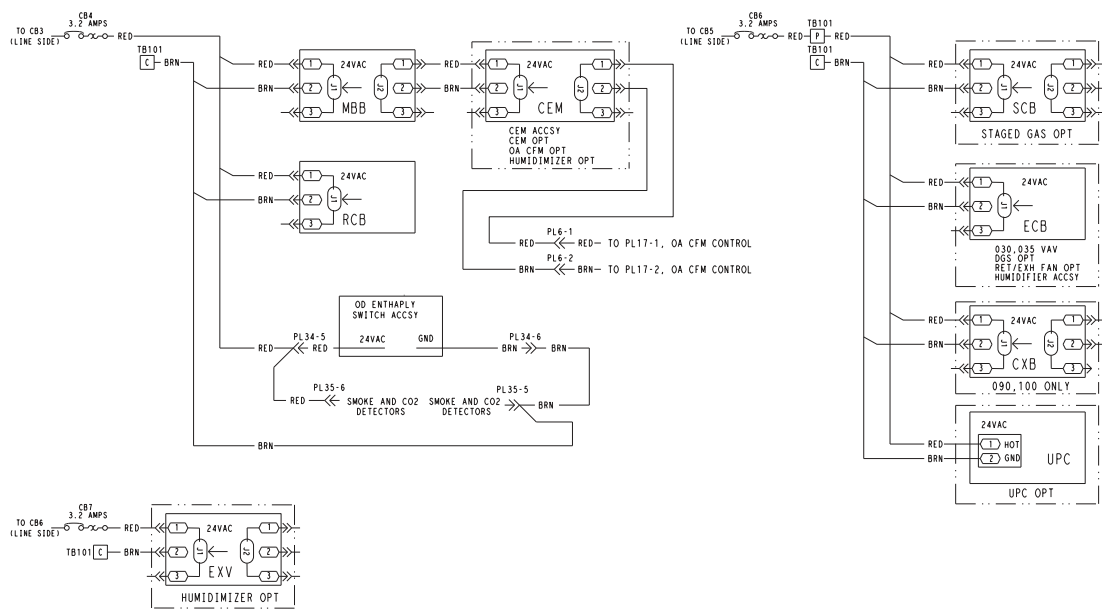

Typical wiring schematics (cont)

CONTROL SECTION — 50P2,P3,P4,P5 UNITS

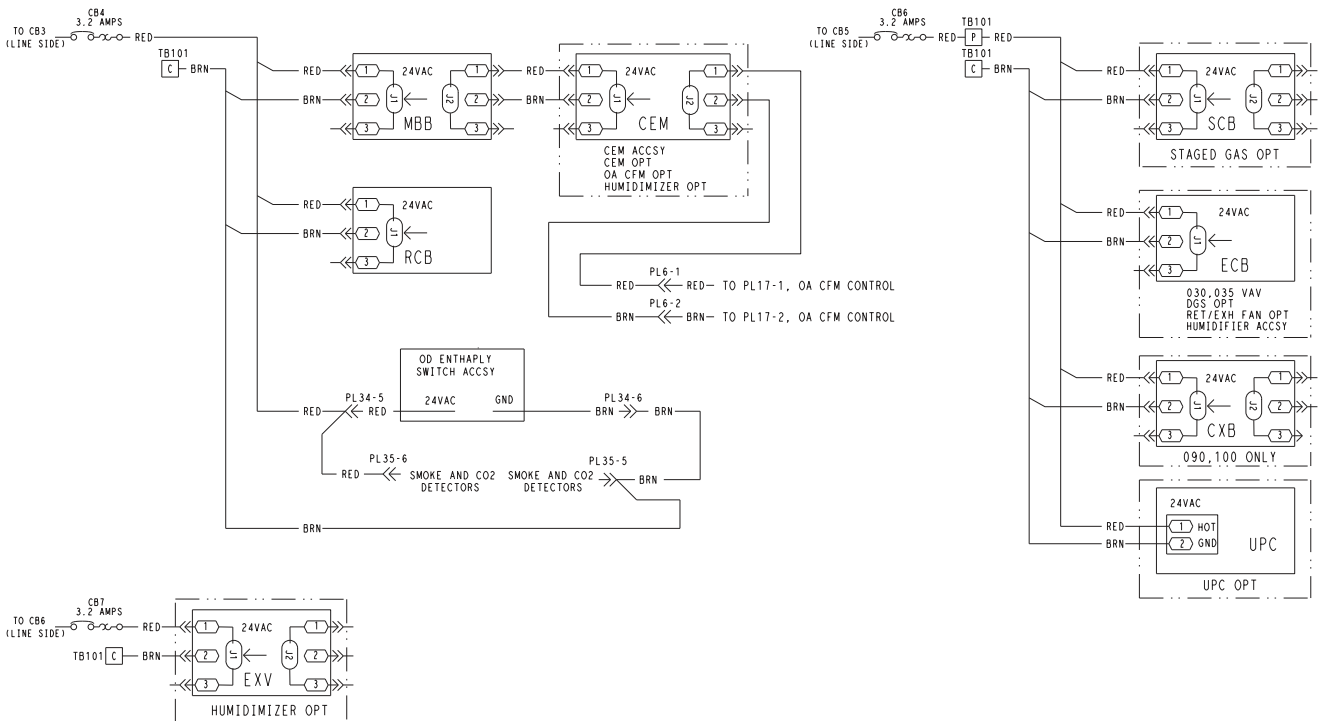
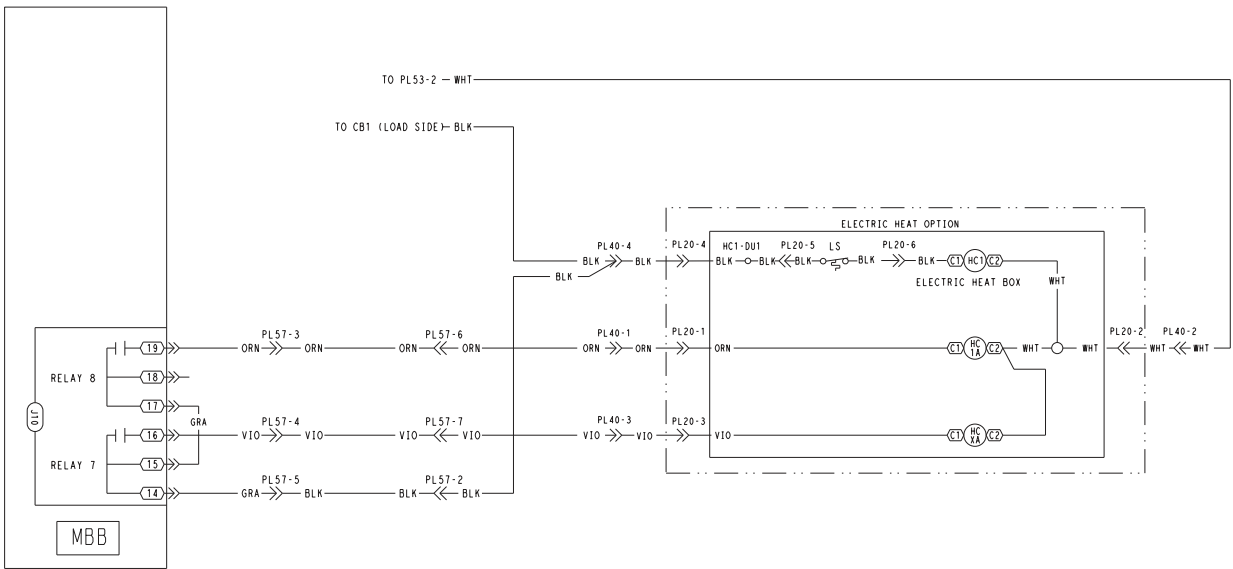

115-VOLT WIRING

- NOTES:**
- MP.A1 NOT USED IN THE FOLLOWING UNITS:
030-040: 460V UNITS WITHOUT DIGITAL SCROLL
050-055: ALL UNITS
060-100: 460V UNITS WITHOUT DIGITAL SCROLL
 - MP.A2 NOT USED IN THE FOLLOWING UNITS:
050-055: ALL UNITS
060-100: 460V UNITS
 - MP.B1 NOT USED IN THE FOLLOWING UNITS:
030-035: 460V UNITS
040-055: ALL UNITS
060-100: 460V UNITS
 - MP.B2 NOT USED IN THE FOLLOWING UNITS:
040-055: ALL UNITS
060-100: 460V UNITS
 - MP.A3 NOT USED IN THE FOLLOWING UNITS:
090,100: 460V UNITS
 - MP.B3 NOT USED IN THE FOLLOWING UNITS:
090,100: 460V UNITS
 - JUMPER PLUG REQUIRED WHEN MP NOT USED

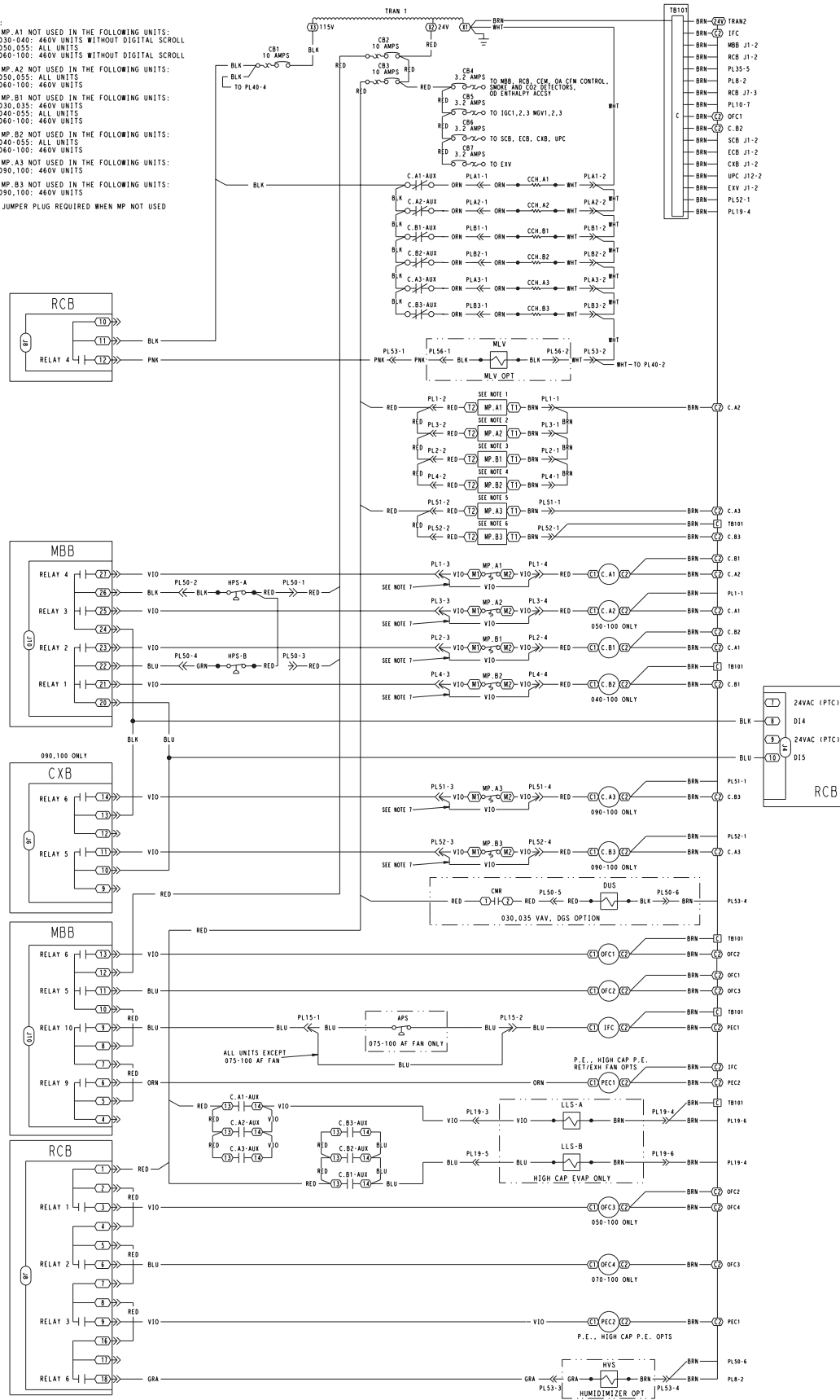

Typical wiring schematics (cont)











LEGEND FOR TYPICAL CONTROL WIRING SCHEMATICS

ACCSY — Accessory
ACCY — Accessory
AF — Air Foil
AN — Analog
APS — Air Pressure Switch
AUX — Auxiliary
C — Compressor Contactor
CAP — Capacity
CB — Compressor Circuit Breaker
CCB — Control Circuit Breaker
CCH — Crankcase Heater
CCN — Carrier Comfort Network®
CCT — Cooling Coil Thermistor
CEM — Controls Expansion Module
CMR — Compressor Modulation Relay
COMP — Compressor
CSB — Current Sensor Board
CXB — Compressor Expansion Board
DGS — Digital Scroll Compressor
DI — Digital Input
DPT — Discharge Pressure Transducer
DUS — Digital Unloader Solenoid
ECB — Economizer Control Board
ECON — Economizer
EQUIP — Equipment
EVAP — Evaporator
EXB — Economizer Control Board
EXH — Exhaust
EXV — Expansion Valve Control Board
FU — Fuse
GND — Ground

HC — Heater Contactor
HIR — Heat Interlock Relay
HMV — Humidi-MiZer® Modulating Valve
HPS — High-Pressure Switch
HVS — Humidi-MiZer Valve Solenoid
IAQ — Indoor Air Quality
IFC — Indoor Fan Contactor
IFCB — Indoor Fan Circuit Breaker
IFM — Indoor Fan Motor
IGC — Integrated Gas Controller
LEN — Local Equipment Network
LLS — Liquid Line Solenoid
MBB — Main Base Board
MGV — Main Gas Valve
MLV — Minimum Load Valve
MP — Modular Motor Protector
OA — Outdoor Air
OAT — Outdoor-Air Thermistor
OD — Outdoor
OFC — Outdoor Fan Contactor
OFM — Outdoor Fan Motor
OPT — Option
PE — Power Exhaust
PEC — Power Exhaust Contactor
PECB — Power Exhaust Circuit Breaker
PEM — Power Exhaust Motor
PL — Plug Assembly
PP — Plenum Pressure
PTC — Positive Temperature Coefficient Power Reference

RA — Return Air
RAT — Return Air Thermistor
RCB — Rooftop Control Board
RET — Return
RF — Return Fan
RXB — Rooftop Control Board
SAT — Supply Air Thermistor
SCB — Staged Gas Control Board
SPT — Suction Pressure Transducer
STDU — Standard Tier Display Unit
TB — Terminal Block
TRAN — Transformer
UPC — Unitary Protocol Converter
VAV — Variable Air Volume
VFD — Variable Frequency Drive

 Terminal Block
 Terminal (Unmarked)
 Terminal (Marked)
 Splice
 Factory Wiring
 Field Wiring
 To indicate common potential only, not to represent wiring.
 To indicate FIOP or Accessory

Guide specifications — 48P2,P3,P4,P5 units



Packaged Rooftop Cooling Unit with Gas Heat and ComfortLink Controls

HVAC Guide Specifications — Section 48P2,P3,P4,P5

Size Range: **30 to 100 Tons, Nominal**

Carrier Model Number:

48P2 (Vertical Supply/Return, Constant Volume [CV] Application, Staged Air Volume [SAV™])

48P3 (Vertical Supply/Return, Variable Air Volume [VAV] Application)

48P4 (Horizontal Supply/Return, Constant Volume Application, Staged Air Volume [SAV])

48P5 (Horizontal Supply/Return, Variable Air Volume Application)

Part 1 — General

1.01 SYSTEM DESCRIPTION

Outdoor, roof-curb mounted, electronically controlled heating and cooling unit utilizing hermetic scroll compressors with crankcase heaters for cooling duty and gas combustion for heating duty. Units shall supply and return air vertically or horizontally as shown on the contract drawings.

1.02 QUALITY ASSURANCE

- A. Unit shall be rated in accordance with AHRI (Air-Conditioning, Heating and Refrigeration Institute) Standard 340/360, latest edition.
- B. Unit shall be designed to conform to ANSI (American National Standards Institute)/ASHRAE (American Society of Heating, Refrigerating and Air-Conditioning Engineers) 15 (latest edition), ASHRAE 62, and UL Standard 1995.
- C. Unit shall be listed by ETL and ETL, Canada, as a total package.
- D. Unit shall be designed to conform to ANSI Standard Z21.47 (U.S.A.)/CSA Standard 2.3 (Canada), Gas-Fired Central Furnaces.
- E. Roof curb shall be designed to NRCA (National Roofing Contractors Association) criteria per Guideline B-1986.
- F. Insulation and adhesive shall meet NFPA (National Fire Protection Association) 90A requirements for flame spread and smoke generation.

1.03 DELIVERY, STORAGE, AND HANDLING

Unit shall be stored and handled per manufacturer's recommendations.

Part 2 — Products

2.01 EQUIPMENT

- A. Factory-assembled, single-piece heating and cooling unit. Contained within the unit enclosure shall be all factory wiring, piping, refrigerant charge (R-410A), operating oil charge, dual refrigerant circuits, micro-processor-based control system and associated

hardware, and all special features required prior to field start-up.

B. Unit Cabinet:

1. Constructed of galvanized steel (designated G90 per ASTM [American Society for Testing and Materials] Standard A653 — minimum coating weight of 0.9 oz of zinc per square foot), bonderized and primer-coated on both sides and coated with a baked polyester thermosetting powdercoating finish on the outer surface.
2. Unit casing shall be capable of withstanding ASTM Standard B117 500-hour salt spray test.
3. Sides shall have *person size* insulated, double wall, hinged access doors for easy access to the control box and other areas requiring servicing. Each door shall seal against a rubber gasket to prevent air and water leakage.
4. Interior cabinet surfaces (except heat exchanger section) shall be insulated with flexible fire-retardant dual-density (1.75-lb/cu ft) fiberglass blanket, coated on the air side. Insulation coating shall be cleanable and shall contain an EPA-registered immobilized antimicrobial agent to effectively resist the growth of bacteria and fungi as proven by tests in accordance with ASTM Standards G21 and G22.
5. Interior cabinet surfaces within heat exchanger section shall be lined with sheet metal on all surfaces, insulated on the side opposite the airstream.
6. Insulation shall be applied by means of adhesion using a water reducible adhesive sprayed onto interior surface. Adhesive shall maintain a satisfactory adhesion and cohesion within the temperature range of -20 to 180 F and have excellent resistance to water and water vapor when cured.
7. Unit shall contain a sloped drain pan, to prevent standing water from accumulating. Pan shall be fabricated of stainless steel. Unit shall contain a factory-installed nonferrous main condensate drain connection.
8. Units shall be equipped with lifting lugs to facilitate overhead rigging.

C. Fans:

1. Supply Fan:
 - a. Unit shall have only one fan wheel, scroll, and motor.
 - b. Fan scroll, wheel, shaft, bearings, drive components and motor shall be mounted on a formed steel assembly which shall be isolated from the unit outer casing with factory-installed 2-in. deflection spring isolators and vibration-absorbent fan discharge seal.
 - c. Fan shall be double-width, double-inlet, centrifugal belt driven forward-curve type with single outlet discharge (standard) or centrifugal belt driven airfoil blade section type with

Guide specifications — 48P2,P3,P4,P5 units (cont)



single outlet discharge (optional). Optional airfoil fan include a high static pressure safety switch installed into the supply air plenum.

- d. Fan wheel shall be designed for continuous operation at the maximum rated fan speed and motor horsepower.
- e. Fan wheel and shaft shall be selected to operate at 25% below the first critical speed and shall be statically and dynamically balanced as an assembly.
- f. Fan shaft shall be solid steel, turned, ground and polished, and coated with rust preventative oil.
- g. Fan shaft bearings shall be self-aligning, pillow-block, regreasable ball or roller-type selected for a minimum average life of 200,000 hours at design operating conditions in accordance with ANSI B3.15.
- h. A single motor shall be mounted within the fan section casing on slide rails equipped with adjusting screws. Motor shall be mounted on a horizontal flat surface and shall not be supported by the fan or its structural members.
- i. Fan drive shall be constant-speed fixed-pitch. All drives shall be factory-mounted, with belts aligned and tensioned.

2. Condenser Fans:

- a. Direct-driven propeller type.
- b. Size 035 units shall have a direct driven, 11-blade airfoil cross section, reinforced polymer construction, and shrouded-axial type fans with inherent corrosion resistance.
- c. Discharge air vertically upward.
- d. Protected by PVC-coated steel wire safety guards.
- e. Statically and dynamically balanced.
- f. Three-phase, totally enclosed motors.

D. Compressors:

- 1. Fully hermetic scroll type compressors with overload protection and short cycle protection with minimum on and off timers.
- 2. Factory rubber-in-shear mounted for vibration isolation.
- 3. Reverse rotation protection capability.
- 4. Crankcase heaters shall only be activated during compressor off mode.

E. Coils:

- 1. Evaporator Coil:
 - a. Intertwined circuiting constructed of aluminum fins mechanically bonded to seamless copper tubes.
 - b. Full-face active type during full and part load conditions.

- c. Coils shall be leak tested at 150 psig and pressure tested at 650 psig.

2. Condenser Coils:

- a. Condenser coils shall be microchannel design. The coils shall have a series of flat tubes containing a series of multiple, parallel flow microchannels layered between the refrigerant manifolds. Microchannel coils shall consist of a two-pass arrangement. Coil construction shall consist of aluminum alloys for the fins, tubes and manifolds.
- b. Air-cooled condenser coils shall be leak tested at 150 psig and pressure tested at 650 psig.

F. Outdoor-Air Hood Assembly:

Factory-installed manual outdoor-air damper shall allow intake of up to 25% nominal airflow (on units not equipped with optional economizer).

G. Heating Section:

- 1. Induced-draft combustion type with energy saving direct spark ignition systems and redundant main gas valves.
- 2. The heat exchanger shall be of the tubular section type constructed of a minimum of 20-gage steel coated with a nominal 1.4 mil aluminum-silicone alloy for corrosion resistance.

Optional construction:

Heat exchanger shall be constructed of minimum 20-gage Type 409 Stainless Steel for corrosion resistance. Tubing material shall be suited for high temperature and corrosion resisting service. Tubing material shall comply with ASTM A268, Grade TP409. Tubing shall be welded and annealed.

- 3. Burners shall be of the in-shot type constructed of aluminized steel.
- 4. Induced Draft Fans:
 - a. Direct-driven, single inlet, forward-curved centrifugal type.
 - b. Statically and dynamically balanced.
 - c. Made from steel with a corrosion-resistant finish.
- 5. High-corrosion areas such as flue gas collection and exhaust areas shall be lined with corrosion-resistant material.
- 6. All gas piping shall enter the unit cabinet at a single location.

H. Refrigerant Components:

Unit shall be equipped with dual refrigerant circuits, each containing:

- 1. Filter drier.
- 2. Moisture indicating sight glass.
- 3. Thermostatic expansion valve.
- 4. Fusible plug.

I. Filter Section:

1. Filter section shall consist of 2-in. thick, MERV (Minimum Efficiency Reporting Value) 7 disposable fiberglass filters of commercially available sizes.
2. Factory 2-in. filter track shall allow easy field conversion to accept 4-in. thick, disposable fiberglass filters of commercially available sizes.

J. Controls, Safeties, and Diagnostics:

1. Controls:

- a. Control shall be accomplished through the use of a factory-installed, microprocessor-based control system and associated electronic and electrical hardware. Control system shall determine control sequences through monitoring the following operational variables:

- 1) Day and Time.
- 2) Schedule (Unoccupied/Occupied).
- 3) Set points (Unoccupied/Occupied, Economizer, Duct Pressure, others).
- 4) Space temperature.
- 5) Outdoor air temperature.
- 6) Unit supply air temperature.
- 7) Unit return air temperature.
- 8) Supply-air fan status.
- 9) Economizer position.
- 10) Compressor suction and discharge pressure.
- 11) Scrolling marquee display.
- 12) Accessory and/or field-supplied sensors, function switches and/or signals.

- b. Controls shall be capable of performing the following functions:

- 1) Capacity control based on supply-air temperature and compensated by rate of change of return-air temperature (VAV) or room temperature (CV). Capacity control shall be accomplished through the use of compressor staging or optional variable output compressors.
- 2) Perform a quick test to check the status of all input and output signals to the control system using scrolling marquee or Navigator™ display.
- 3) Control of integrated economizer operation, based on unit supply-air temperature.
- 4) Supply fan volume control shall control output from a variable frequency drive to maintain duct static pressure at user-configured set point (VAV). Static pressure reset in conjunction with Carrier communicating terminals to reduce supply fan power requirements. Control system calculates the amount of supply static pressure reduction necessary to cause the most open damper in the system to open more than the minimum

value (60%) but not more than the maximum value (90% or negligible static pressure drop).

- 5) Heating control shall provide space temperature control for unoccupied period heating, morning warm-up sequence and occupied period heating (when configured).
- 6) Adaptive optimal start shall determine the time unit will commence cooling (or heating or heating for morning warm-up) during the unoccupied mode to ensure occupied space reaches the set point in time for occupied mode.
- 7) Adaptive optimal stop shall turn off the compressors a preset amount of time before the end of the occupied mode to conserve energy (CV only).
- 8) Alerts and Alarms: Control shall continuously monitor all sensor inputs and control outputs to ensure safe and proper system operation. Alerts shall be generated whenever sensor conditions have gone outside criteria for acceptability. Alarms shall be initiated when unit control detects that a sensor input value is outside its valid range (indicating a defective device or connection that prevents full unit operation) or that an output has not functioned as expected or that a safety device has tripped. Current alarms shall be maintained in STATUS function; up to 9 (current or reset) shall be stored in HISTORY function for recall.
- 9) Timed override function shall permit a system in unoccupied mode to be returned to occupied mode for a user-configured period of 1, 2, 3 or 4 hours by pressing the override button on the front of the space temperature sensor.
- 10) Nighttime Free Cooling (NTFC) shall start the supply fan and open the economizer on cool nights to precool the building structure mass using only outdoor air. Function shall be restricted to operation above a user-configured low lockout temperature set point.
- 11) Modulating power exhaust control shall modulate capacity of exhaust fan system in response to building static pressure at user-configured set point. Power exhaust fan operation shall be interlocked with supply fan operation.
- 12) Return fan control (on optional return fan equipped units only) shall measure supply fan CFM and modulate return fan to maintain constant CFM differential between supply and return fan. Return fan operation shall be interlocked with supply fan operation.

Capacity of exhaust air shall modulate in response to building static pressure at user-configured set point.

- 13) Smoke control functions: Control shall initiate any of four separate smoke control functions in response to closure of field switches. Functions shall include: Pressurization, Evacuation, Smoke Purge and Fire Shutdown. Should two or more switches be closed simultaneously, Fire Shutdown shall be initiated.
- 14) Support demand controlled ventilation through a reset of the economizer's minimum position. This reset based on differential CO₂ ppm (outdoor and indoor) can be chosen as linear or as fast or slow-acting exponential curves.
- 15) Indoor air quality (IAQ) mode shall admit fresh outdoor air into the space whenever space air quality sensors detect unsuitable space conditions, by overriding economizer minimum damper position. IAQ shall be permitted only during occupied periods, unless configured to be allowed during unoccupied periods also.
- 16) Provide control for reheat via auxiliary heating coil or gas heat during ventilation.
- 17) IAQ pre-occupancy purge function shall provide complete exchange of indoor air with fresh air during unoccupied periods, when outdoor conditions permit. Function shall energize supply fan and open economizer two hours before next occupied period; duration of purge shall be user-configured (5 to 60 minutes).
- 18) Outdoor Air Control (OAC) function shall maintain a minimum quantity of outdoor airflow into an occupied space. OAC mode shall be available only during an occupied period. Outdoor airflow shall be monitored by an airflow station and transducer. Economizer maximum damper opening position during OAC mode shall be user-configured.
- 19) Dehumidification and Reheat: Dehumidification function shall override comfort condition set points to deliver cooler air into the space and satisfy a user-configured humidity set point at the space or return air humidity sensor. Reheat function shall energize an auxiliary heating device should dehumidification operation result in cooling of the space down to the occupied heating set point.
- 20) Supply Air Temperature Set Point Reset: Control shall automatically reset the unit supply air temperature set point on VAV models from either space temperature or return-air temperature, at user-configured rate and limit. Control

shall also reset supply air temperature set point via external 2 to 10 vdc signal representing 0° to 20° F range of reset. Control shall respond to higher of either reset if both are active.

- 21) Space Temperature Offset function shall permit occupants to adjust space temperature set point by $\pm 5^\circ$ F using T-56 space sensor (equipped with sliding scale adjuster).
- 22) Lead-lag function shall distribute starts between the two refrigeration circuits in an effort to equalize the running time on the two circuits.
- 23) Condenser-fan cycling control shall maintain correct head pressure down to 0° F.
- 24) Refrigeration system pressures shall be monitored via pressure transducers. Alarms for low pressure, high pressure will be permitted.
- 25) Timed Discrete Output function shall control an external function or device via user-configured activity schedule. This schedule shall be separate and different from the unit's occupied/unoccupied time schedule.
- 26) Humidifier control shall provide control for either LEN (local equipment network) communicating control valve or discrete-type output, to maintain space humidity conditions at user-configured set points.
- 27) Two-step demand limit control (when used in conjunction with CEM [controls expansion module]).
- 28) Display in Metric units: Display may be configured to display data in Metric or English (Imperial) units of measure.

2. Safeties:

Unit components shall be equipped with the following protections:

a. Compressors:

- 1) Overcurrent using calibrated circuit breakers (shuts down individual compressor).
- 2) Crankcase heaters.
- 3) High-pressure switch (shuts down individual circuit, automatic reset type).
- 4) Low-pressure switch (shuts down individual circuit, automatic reset type).
- 5) Check filter switch.

b. Belt-Drive Fan Motors:

Overcurrent protection manual reset circuit breakers.

c. Airfoil Supply Fan and Airfoil Return Fan (when equipped):

High static pressure safety switch installed into the associated air plenum.

- d. Heating Section:
 - 1) Redundant gas valves.
 - 2) Flame proving controls.
 - 3) Induced-draft fan motor speed sensor.
 - 4) High-temperature limit switch.
 - 5) Flame rollout switch.

3. Diagnostics:

- a. The display shall be capable of indicating a safety lockout condition (alarm) through an expandable scrolling display.
- b. The display shall also be capable of indicating an alert condition which does not lock out the unit, but informs the system monitor of a condition which could be detrimental to either the unit or the comfort of the occupants if allowed to continue.
- c. Test mode must also be capable of displaying outputs of microprocessor-controller and to verify operation of every thermistor, actuator motor, fan, and compressor before unit is started.

K. Operating Characteristics:

- 1. Unit shall be capable of starting and running at 115 F ambient outdoor temperature per maximum load criteria of AHRI Standard 340/360, latest edition.
- 2. Unit shall be capable of mechanical cooling operation down to 32 F ambient outdoor temperature (-20 F with low ambient accessory).
- 3. Provides multi-stage cooling capability.
- 4. Provides 2 stages of heating capability.

L. Motors:

- 1. Compressor motors shall be cooled by suction gas passing over motor windings.
- 2. Condenser-fan motors shall be 3-phase, totally enclosed type with permanently lubricated ball bearings and internal over-temperature protection.
- 3. Supply and exhaust fan motors shall be of the 3-phase, NEMA (National Electrical Manufacturers Association) rated, open drip-proof (ODP), ball bearing type, with efficiencies per EISA (Energy Independence and Security Act) of 2007 (U.S.A.) requirements.

M. Electrical Requirements:

All unit power wiring shall enter unit cabinet at a single location.

N. Special Features:

- 1. Digital Compressor:

A digital compressor shall be available on the lead circuit for constant volume and variable air volume configurations. The ComfortLink control system shall be capable of unloading this compressor in an infinite number of steps from

100% of unit capacity down to 50% of compressor capacity.

2. Humidi-MiZer® Adaptive Dehumidification:

The Humidi-MiZer dehumidification system shall be factory installed with an e-coated reheat coil, and shall provide greater dehumidification of the occupied space by using two modes of dehumidification instead of the normal design cooling mode of the unit:

- a. Subcooling mode shall further sub-cool the hot liquid refrigerant leaving the condenser coil when both temperature and humidity in the space are not satisfied.
- b. Hot gas reheat mode shall mix a portion of the hot gas from the discharge of the compressor with the hot liquid refrigerant leaving the condenser coil to create a two-phase heat transfer in the system, resulting in a neutral leaving-air temperature.
- c. The system shall be equipped with modulating control valves to provide precise leaving-air temperature control. On-off, cycling type control shall not be acceptable.

3. Integrated Economizer:

Dry bulb, differential dry bulb temperature, enthalpy, or optional differential enthalpy controlled integrated type consisting of dampers, actuator, and linkages in conjunction with control system to provide primary cooling using outdoor air, enthalpy permitting, supplemented with mechanical cooling when necessary.

- a. Economizer shall meet the requirements of the California Energy commission airside economizer acceptance test.
- b. Dampers shall be a gear driven low-leakage type.
- c. Actuator shall have a spring-return feature which shuts dampers upon a power interruption or unit shutdown. Actuators are capable of internal diagnostics.
- d. Equipped with a solid-state humidity sensor that is capable of sensing outdoor-air heat content (temperature and humidity) and controlling economizer cut-in point at most economical level. The user can also configure dew point limiting.

4. Ultra Low Leak Economizer:

Dry bulb, differential dry bulb temperature, enthalpy, or optional differential enthalpy controlled integrated type consisting of dampers, actuator, and linkages in conjunction with control system to provide primary cooling using outdoor air, enthalpy permitting, supplemented with mechanical cooling when necessary.

- a. Economizer shall meet the requirements of the California Energy Commission Title 24 economizer requirements.
 - b. Dampers shall be a gear driven ultra low leakage type with blade and edge seals. Dampers shall exhibit a maximum leakage rate of 3 cfm per square foot of area at 1 in. wg pressure differential when tested in accordance with AMCA (Air Movement and Control Association) Standard 500.
 - c. Actuator shall have a spring-return feature which shuts dampers upon a power interruption or unit shutdown. Actuators are capable of internal diagnostics.
 - d. Equipped with a solid-state humidity sensor that is capable of sensing outdoor-air heat content (temperature and humidity) and controlling economizer cut-in point at most economical level. The user can also configure dew point limiting.
5. Modulating Power Exhaust with VFD (Variable Frequency Drive):
- Package shall include 2 double-width, double-inlet centrifugal belt drive, forward-curved power exhaust fans with variable frequency drive control of each fan to maintain a field-adjustable interior space pressure set point.
- a. Fan bearings shall be of the pillow block type with an average design life of 200,000 hours.
 - b. Fans shall be statically and dynamically balanced.
 - c. Bypass for the VFD shall be available as a factory-installed option.
 - d. Differential pressure transducer for monitoring space pressure.
 - e. Exhaust air hood assemblies containing backdraft dampers on each fan outlet, factory installed.
 - f. All wiring and pressure tubing (except to space pressure pickup location) shall be factory supplied and installed.
6. High-Capacity Modulating Power Exhaust System (75 to 100 ton units only):
- High-capacity modulating power exhaust system shall be factory-installed and contain fans and motors, exhaust hoods and controls (including variable frequency drive and staging sequence) to maintain space pressure at user-configured set point.
- a. Dual fan assemblies with individual motors.
 - b. Variable frequency drive for modulating capacity of lead fan.
 - c. Staged control on lag fan.
 - d. Differential pressure transducer for monitoring space pressure.
 - e. Exhaust air hood assemblies containing backdraft dampers on each fan outlet, factory installed.
 - f. All wiring and pressure tubing (except to space pressure pickup location) shall be factory supplied and installed.
7. Return Fan/Building Pressure Control (75 to 100 ton units only):
- a. Functions provided shall be:
 - 1) Airflow control for return duct path (dedicated to overcoming flow losses in return duct system).
 - 2) Modulate return airflow rate to track supply fan airflow rate and maintain a user set delta cfm between the supply and return airflow.
 - 3) Maintain building pressure by sensing building pressure and modulating fan speed.
 - b. Option shall consist of following hardware:
 - 1) Plenum fan assembly, with welded steel airfoil blade fan.
 - 2) Spring isolation.
 - 3) Belt-drive fan system, fixed pitch for maximum belt life and reliability.
 - 4) Variable frequency drive (VFD) for return fan modulation control.
 - 5) Supply air CFM and return air CFM sensors to measure supply and return airflow.
 - 6) Exhaust damper with outlet hood.
 - 7) Building pressure transducer.
 - 8) Shall include a high static pressure safety switch installed into the return air plenum.
 - c. Installation:
 - 1) Site installation shall require supply and installation of building pressure (BP) sensing pick-up and tube to connect to BP transducer in unit.
 - 2) All other wiring and pressure tubing shall be factory-supplied and factory installed.
8. Barometric Relief Package:
- a. Package shall relieve excess internal pressure and consist of damper assemblies, hoods, damper screens, seal strips and required hardware.
 - b. Damper assemblies shall close due to gravity upon unit shutoff.
9. Pleated Filters:
- Unit shall be factory equipped with MERV 7 pleated filters having the following characteristics:
- a. Efficiency of no less than 30% based on testing per ASHRAE Standard 52.
 - b. Minimum average arrestance of 95%.

10. High-Efficiency Pleated Filters (75 to 100 ton units only):
Unit shall be factory equipped with MERV 11 high-efficiency pleated filters having the following characteristics:
 - a. Filters shall have a design dust spot efficiency with an average of 60 to 65% based on the ASHRAE Standard 52.1 test method.
 - b. Filters shall have a minimum arrestance of 90%.
 - c. Filters shall be classified as a Class 2 air filter according to UL Standard 900.
11. Bag Filters with Prefilters (30 to 70 ton units only):
Unit shall be factory equipped with MERV 15 bag filters and 2-in. prefilters, and shall have an average efficiency of 90% based on testing per ASHRAE Standard 52.
12. Cartridge Filters with Prefilters (30 to 70 ton units only):
Unit shall be factory equipped with cartridge filter mounting system with 2-in. prefilters.
13. Supply Fan Variable Frequency Drive:
Variable air volume and staged air volume units shall be equipped with variable frequency drive (VFD) inverter. The VFD shall be factory-mounted, wired, and tested. The variable speed drive shall include the following features:
 - a. Factory-supplied VFDs qualify, through ABB, for a 24-month warranty from date of commissioning or 30 months from date of sale, whichever occurs first.
 - b. Full digital control with direct control from the unit ComfortLink controls.
 - c. Insulated gate bi-polar transistors (IGBT) used to produce the output pulse width modulated (PWM) waveform, allowing for quiet motor operation.
 - d. Inverters capable of operation at a frequency of 8 kHz so no acoustic noise shall be produced by the motor.
 - e. VFDs shall include EMI/RFI (electromagnetic/radio frequency interference) filters.
 - f. Digital display keypad module, mounted on the VFD enclosure.
 - g. Local/Remote and Manual/Auto function keys on the keypad.
 - h. UL-listed electronic overload protection.
 - i. Critical frequency avoidance.
 - j. Self diagnostics.
 - k. On-board storage of unit manufacturer's customer user settings, retrievable from the keypad.
 - l. RS485 communications capability (accessory card source required).
 - m. Internal thermal overload protection.
 - n. 5% swinging (non-linear) chokes for harmonic reduction and improved power factor.
 - o. All printed circuit boards shall be conformal coated.
14. Supply Fan Static Pressure Control (VAV units):
Variable air volume units shall be equipped with a supply fan VFD. The VFD shall control motor speed to maintain set point static pressure control at the supply duct sensor tube location. The supply fan drive shall be field-adjustable to maintain supply duct static pressure set point from 0.0-in. wg to 5-in. wg, adjusted via scrolling marquee display or Navigator™ display. A pressure transducer shall be factory-mounted and wired. (Control tubing from sensor tube location to transducer shall be field-supplied and installed.) Transducer shall provide a 4 to 20 mA signal to the unit control module; unit control module shall provide a 4 to 20 mA signal to the VFD indicating desired VFD output level.
15. Staged Air Volume (SAV™) Units:
Staged air volume units shall be equipped with a supply fan VFD. The VFD shall control motor speed to user configurable speeds. High speed shall be a percentage of 60 Hz, and shall be user configurable. The range of adjustment for high speed shall be between 67 and 100% of 60 Hz. Low speed shall be a percentage of 60 Hz, and shall be user configurable. The range of adjustment for low cooling speed shall be between 33 and 67% of 60 Hz. The range of adjustment for low heating speed shall be between 75 and 100% of 60 Hz. The control shall allow user configurable fan speeds for cooling and heating modes.
16. Staged Gas Control:
 - a. Staged gas control option shall monitor unit supply-air temperature and sequence the unit heat exchanger staging to provide the following sequences:
 - 1) Tempering heat control, based on user-configured ventilation supply air temperature set point, to eliminate cold draft conditions with low mixed-air temperatures.
 - 2) First-stage demand heating control, with staging selected to maintain user-configured heating supply air temperature set point.
 - 3) Full-fire demand heating on heating control command.
 - b. Staged gas control option shall consist of:
 - 1) Supply air temperature thermistors with duct-mounting base.
 - 2) Limit switch temperature thermistor.
 - 3) Stainless steel heat exchanger tubes and construction option.

- c. Field installation shall be limited to installing three supply air temperature thermistors in the supply duct. All other hardware, wiring and piping shall be factory-completed.
17. Modulating Gas Heat:
- a. Modulating gas heat option shall monitor unit supply-air temperature and control the unit heat exchanger to provide the following sequences:
- 1) First-stage demand heating control, with modulation to maintain user-configured heating supply air temperature set point. Turndown ratio to be at least 4:1 (325 MBtuh), 7:1 (650 MBtuh) and 11:1 (975 MBtuh).
 - 2) Full-fire demand heating on heating control command.
 - 3) Tempering heat control, based on user-configured ventilation supply air temperature set point, to eliminate cold draft conditions with low mixed-air temperatures.
- b. Modulating gas control option shall consist of:
- 1) Modulating controller capable of ensuring the proper fuel air mixture at operating firing rates.
 - 2) Supply air temperature thermistors with duct-mounting base.
 - 3) Limit switch temperature thermistor.
 - 4) Stainless steel heat exchanger tubes.
- c. Field installation shall be limited to installing three supply air temperature thermistors in the supply duct. All other hardware, wiring and piping shall be factory-completed.
18. LP (Liquid Propane) Conversion Kit (30 to 70 ton units only):
Provides all necessary hardware and labels for conversion from natural gas to LP gas. (Not for use with staged gas control option.)
19. Extended Chassis:
Extended chassis designs shall contain an added length module, after the evaporator section, before the supply fan section as shown in the contract drawings. Module shall contain tracks to accept field-supplied and installed auxiliary heating coil.
20. Non-Fused Disconnect:
A non-fused electrical disconnect for main unit power shall be factory installed. The disconnect shall be an interlocking through-the-door type.
21. 115-Volt Convenience Outlet:
A duplex GFCI (ground fault circuit interrupt) receptacle shall be factory mounted in a weatherproof enclosure and wired for a 10-amp load. It will remain powered when all unit circuit breakers have been turned off. The outlet will be deenergized by the unit disconnect.
22. Navigator™ Display Module:
The Navigator display module shall be a portable hand-held display module with a minimum of 4 lines and 20 characters per line, of clear English, Spanish, Portuguese or French language. Display menus shall provide clear language descriptions of all menu items, operating modes, configuration points and alarm diagnostics. Reference to factory codes shall not be accepted. An industrial grade coiled extension cord shall allow the display module to be moved around the chiller. Magnets shall hold the display module to any sheet metal panel to allow hands-free operation. Display module shall have NEMA 4x housing suitable for use in outdoor environments. Display shall have back light and contrast adjustment for easy viewing in bright sunlight or night conditions. The display module shall have raised surface buttons with positive tactile response.
23. Controls Expansion Module (CEM):
Factory-installed package shall include all hardware for additional control of base unit operation and product integrated controls features. The functions supported are:
- a. Building pressurization, evacuation, and smoke purge control.
 - b. Supply air reset from external 4 to 20 mA signal.
 - c. Two-step demand limit inputs (when used with the CCN [Carrier Comfort Network®] network).
 - d. Indoor air quality (IAQ) switch monitoring.
 - e. Outdoor airflow monitoring
 - f. Outdoor humidity monitoring.
 - g. Space humidity monitoring (required for dehumidification control, reheat and humidifier control).
 - h. Return air humidity monitoring.
 - i. Demand limiting from an external 4 to 20 mA signal.
 - j. Static pressure reset from an external 4 to 20 mA signal.
24. Relative Humidity Sensors:
Package shall contain either duct-mounted or wall-mounted sensors to measure the relative humidity of the air within the occupied space (specify location) or return duct and/or outside air.
NOTE: For relative humidity sensor monitoring, the CEM must also be ordered.
25. Indoor Air Quality (CO₂) Sensor:
a. Shall have the ability to provide demand ventilation indoor-air quality (IAQ) control through the economizer with an indoor air quality sensor.

- b. The IAQ sensor shall be available in duct mount, wall mount, and wall mount with LED display of CO₂ in parts per million. The set point shall have adjustment capability.
26. Return Air Smoke Detector:
The smoke detector shall send input to the controller to shut down the unit in case smoke is detected.
27. Outdoor Airflow Sensor:
Outdoor airflow sensor package shall contain a airflow station with airflow sensor, a transducer and all hardware required to measure the quantity of outdoor air brought in through the economizer dampers. Optional economizer and CEM are required with this accessory.
This airflow sensor shall control to the following airflow ranges:
Sizes 030-050: 2,500 to 12,500 CFM
Sizes 055-070: 3,000 to 17,000 CFM
Sizes 075-100: 5,000 to 21,000 CFM
28. Differential Enthalpy Switch or Sensors (when equipped with both return air and outdoor air humidity sensors):
- For use with economizer only.
 - Capable of comparing heat content (temperature and humidity) of outdoor and return air and controlling economizer cut-in point at the most economical level.
29. Hot Gas Bypass:
Unit shall be factory equipped with hot gas bypass valve and tubing to maintain capacity control at minimal cooling loads.
30. Condenser Coil Protective Coating — E-Coated Microchannel Coil:
E-coated aluminum microchannel coils shall have a flexible epoxy polymer coating uniformly applied to all coil external surface areas without material bridging between fins or louvers. Coating process shall ensure complete coil encapsulation, including all exposed fin edges. E-coat thickness of 0.8 to 1.2 mil with top coat having a uniform dry thickness from 1.0 to 2.0 mil on all external coil surface areas, including fin edges, shall be provided. E-coated coils shall have superior hardness characteristics of 2H per ASTM D3363-00 and cross-hatch adhesion of 4B-5B per ASTM D3359-02. E-coated coils shall have superior impact resistance with no cracking, chipping, or peeling per NSF/ANSI 51-2002 Method 10.2.
31. Condenser Coil Hail Guard (sizes 040 to 060 only):
Canted face enclosure and welded wire grille complete with support retainers and fasteners shall be provided for protection of condenser coils. Field-assembled.
32. BACnet Communication Option:
Shall provide factory-installed communication capability with a BACnet MS/TP network. Allows integration with i-Vu[®] Open control system or a BACnet Building Automation System.
33. MODBUS Protocol Translator:
A controller-based accessory module shall provide CCN access to MODBUS Remote Terminal Unit (RTU) protocol conversion.
34. LonWorks Protocol Translator:
A controller-based accessory module shall provide CCN access to LON FT-10A ANSI/EIA-709.1 protocol conversion.
35. Space Temperature Sensor (T-56):
The T-56 space temperature sensor (for CV applications) shall monitor space temperature. Device shall be suited for wall mounting in the occupied space. The T-56 sensor shall incorporate a front-panel located slider switch to effect a remote change in set point of $\pm 5^{\circ}$ F. The T-56 sensor shall also include a button used to initiate Unoccupied Override function.
36. Space Temperature Sensor (T-56) with CO₂ Sensor:
This device shall incorporate interior space temperature sensing and interior space CO₂ level monitoring functions. Space temperature sensor shall sense the actual temperature in the conditioned space via 10,000-ohm thermistor. Temperature set point adjustment potentiometer via slide scale shall provide $\pm 5^{\circ}$ F adjustment. The CO₂ sensor shall provide CO₂ measurement range of 0 to 2000 ppm. IAQ signal to unit base board terminals shall be 4 to 20 mA. Sensor shall be equipped with an override button for timed override. Sensor must be powered by a separate field-supplied 24-v transformer.
37. Suction and Liquid Service Valves:
Shall be equipped with ball type service valves in the suction and liquid line for each circuit.
38. Discharge Service Valve:
Shall be equipped with a ball type service valve in the discharge line of each circuit.
39. Replaceable Core Filter Drier:
Shall be equipped with a replaceable core filter drier in each liquid line.
40. Roof Curb:
Designed to comply with criteria established by NRCA Guideline B-1986.
- Size 030-060 Units:
Formed 14-gage galvanized steel with wood nailer. Supports full perimeter of unit.
 - Size 070-100 Units:
Formed 14-gage galvanized steel with wood nailer strip as perimeter curb supporting the

Guide specifications — 48P2,P3,P4,P5 units (cont)



- air-handling portion of unit, and rail for supporting the condenser portion of the unit.
41. Roof Curb Condenser Section (accessory for size 070-100 units only):
Formed 14-gage galvanized steel with wood nailer strip for supporting condenser section of the unit to complete a full perimeter curb under entire unit.
42. Low Outdoor Sound:
Low sound fans for outdoor sound reduction shall be available as a factory-installed option for all units (except 35 ton units).
43. Low Ambient Control:
a. Control shall regulate fan motor speed in response to the saturated condensing temperature of the unit. The control shall be capable of operating with outdoor temperatures at -20 F.
b. Motormaster® low ambient control shall be available as a factory-installed option or field-installed accessory for all units.
44. Short Circuit Current Rating (SCCR):
An optional SCCR of 65kA shall be provided for 208/230 and 460 volt units. An optional of 25kA shall be provided for 575 volt units.
45. Low Compressor Sound Blanket:
Low compressor sound blanket accessory shall be available for field installation.

Guide specifications — 50P2,P3,P4,P5 units



Packaged Rooftop Cooling Unit with ComfortLink Controls and Optional Electric or Hydronic Heat

HVAC Guide Specifications — Section 50P2,P3,P4,P5

Size Range: **30 to 100 Tons, Nominal**

Carrier Model Number:

50P2 (Vertical Supply/Return, Constant Volume [CV] Application, Staged Air Volume [SAV™])

50P3 (Vertical Supply/Return, Variable Air Volume [VAV] Application)

50P4 (Horizontal Supply/Return, Constant Volume Application, Staged Air Volume [SAV])

50P5 (Horizontal Supply/Return, Variable Air Volume Application)

NOTE: Items throughout the specification which apply only to units with electric or hydronic heat are indicated by single brackets [i.e.].

Part 1 — General

1.01 SYSTEM DESCRIPTION

Outdoor, roof-curb mounted, electronically controlled cooling [and heating] unit utilizing hermetic scroll compressors with crankcase heaters for cooling duty [and utilizing electric resistance coils for heating duty]. Units shall supply and return air vertically or horizontally as shown on the contract drawings.

1.02 QUALITY ASSURANCE

- A. Unit shall be rated in accordance with AHRI (Air-Conditioning, Heating, and Refrigeration Institute) Standard 340/360, latest edition.
- B. Unit shall be designed to conform to ANSI (American National Standards Institute)/ASHRAE (American Society of Heating, Refrigerating, and Air-Conditioning Engineers) 15 (latest edition), ASHRAE 62, and UL Standard 1995.
- C. Unit shall be listed by ETL and ETL, Canada, as a total package.
- D. Roof curb shall be designed to NRCA (National Roofing Contractor's Association) criteria per Guideline B-1986.
- E. Insulation and adhesive shall meet NFPA (National Fire Protection Association) 90A requirements for flame spread and smoke generation.

1.03 DELIVERY, STORAGE, AND HANDLING

Unit shall be stored and handled per manufacturer's recommendations.

Part 2 — Products

2.01 EQUIPMENT

- A. Factory-assembled, single-piece heating and cooling unit. Contained within the unit enclosure shall be all factory wiring, piping, refrigerant charge (R-410A), operating oil charge, dual refrigerant circuits, micro-processor-based control system and associated

hardware, and all special features required prior to field start-up.

B. Unit Cabinet:

1. Constructed of galvanized steel (designated G90 per ASTM [American Society for Testing and Materials] Standard A653 — minimum coating weight of 0.9 oz of zinc per square foot), bonderized and primer-coated on both sides and coated with a baked polyester thermosetting powdercoating finish on the outer surface.
2. Unit casing shall be capable of withstanding ASTM Standard B117 500-hour salt spray test.
3. Sides shall have *person size* insulated, double wall, hinged access doors for easy access to the control box and other areas requiring servicing. Each door shall seal against a rubber gasket to prevent air and water leakage.
4. Interior cabinet surfaces (except heat exchanger section) shall be insulated with flexible fire-retardant dual-density (1.75-lb/cu ft) fiberglass blanket, coated on the air side. Insulation coating shall be cleanable and shall contain an EPA-registered immobilized antimicrobial agent to effectively resist the growth of bacteria and fungi as proven by tests in accordance with ASTM Standards G21 and G22.
5. Insulation shall be applied by means of adhesion using a water reducible adhesive sprayed onto interior surface. Adhesive shall maintain a satisfactory adhesion and cohesion within the temperature range of -20 to 180 F and have excellent resistance to water and water vapor when cured.
6. Unit shall contain a sloped drain pan, to prevent standing water from accumulating. Pan shall be fabricated of stainless steel. Unit shall contain a factory-installed nonferrous main condensate drain connection.
7. Units shall be equipped with lifting lugs to facilitate overhead rigging.

C. Fans:

1. Supply Fan:
 - a. Unit shall have only one fan wheel, scroll, and motor.
 - b. Fan scroll, wheel, shaft, bearings, drive components and motor shall be mounted on a formed steel assembly which shall be isolated from the unit outer casing with factory-installed 2-in. deflection spring isolators and vibration-absorbent fan discharge seal.
 - c. Fan shall be double-width, double-inlet, centrifugal belt driven forward-curve type with single outlet discharge (standard) or centrifugal belt driven airfoil blade section type with single outlet discharge (optional). Option airfoil fan include a high static pressure safety switch installed into the supply air plenum.

- d. Fan wheel shall be designed for continuous operation at the maximum rated fan speed and motor horsepower.
 - e. Fan wheel and shaft shall be selected to operate at 25% below the first critical speed and shall be statically and dynamically balanced as an assembly.
 - f. Fan shaft shall be solid steel, turned, ground and polished, and coated with rust preventative oil.
 - g. Fan shaft bearings shall be self-aligning, pillow-block, regreasable ball or roller-type selected for a minimum average life of 200,000 hours at design operating conditions in accordance with ANSI B3.15.
 - h. A single motor shall be mounted within the fan section casing on slide rails equipped with adjusting screws. Motor shall be mounted on a horizontal flat surface and shall not be supported by the fan or its structural members.
 - i. Fan drive shall be constant-speed fixed-pitch. All drives shall be factory-mounted, with belts aligned and tensioned.
2. Condenser Fans:
 - a. Direct-driven propeller type.
 - b. Size 035 units shall have a direct driven, 11-blade airfoil cross section, reinforced polymer construction, and shrouded-axial type fans with inherent corrosion resistance.
 - c. Discharge air vertically upward.
 - d. Protected by PVC-coated steel wire safety guards.
 - e. Statically and dynamically balanced.
 - f. Three-phase, totally enclosed motors.
- D. Compressors:
1. Fully hermetic scroll type compressors with overload protection and short cycle protection with minimum on and off timers.
 2. Factory rubber-in-shear mounted for vibration isolation.
 3. Reverse rotation protection capability.
 4. Crankcase heaters shall only be activated during compressor off mode.
- E. Coils:
1. Evaporator Coil:
 - a. Intertwined circuiting constructed of aluminum fins mechanically bonded to seamless copper tubes.
 - b. Full-face active type during full and part load conditions.
 - c. Coils shall be leak tested at 150 psig and pressure tested at 650 psig.
 2. Condenser Coils:
 - a. Condenser coils shall be microchannel design. The coils shall have a series of flat tubes containing a series of multiple, parallel flow microchannels layered between the refrigerant manifolds. Microchannel coils shall consist of a two-pass arrangement. Coil construction shall consist of aluminum alloys for the fins, tubes and manifolds.
 - b. Air-cooled condenser coils shall be leak tested at 150 psig and pressure tested at 650 psig.
- F. Outdoor-Air Hood Assembly:
Factory-installed manual outdoor-air damper shall allow intake of up to 25% nominal airflow (on units not equipped with optional economizer).
- G. [Electric Heating Section:]
Electric resistance heaters shall be factory installed, open wire nichrome element type, insulated with ceramic bushings, and shall include operating and safety controls.
- H. [Hydronic Heating Section:]
Hydronic heating option shall consist of factory-installed plate fin-tube coil assembly, installed in the extended length section. Coil assembly shall be supplied with die-formed casing and tube sheets of mill galvanized steel. Tubes shall be minimum 1/2-in. OD copper tubes mechanically expanded into aluminum plate fin coils with belled collars. Headers shall be constructed of steel with steel MPT connections. Headers shall have drain and vent connections. Coils shall be suitable for a design working pressure of 300 psig at 200 F. Coils shall be tested at 450 psig air pressure.
- I. Refrigerant Components:
Unit shall be equipped with dual refrigerant circuits, each containing:
1. Filter drier.
 2. Moisture indicating sight glass.
 3. Thermostatic expansion valve.
 4. Fusible plug.
- J. Filter Section:
1. Filter section shall consist of 2-in. thick, MERV (Minimum Efficiency Reporting Value) 7 disposable fiberglass filters of commercially available sizes.
 2. Factory 2-in. filter track shall allow easy field conversion to accept 4-in. thick, disposable fiberglass filters of commercially available sizes.
- K. Controls, Safeties, and Diagnostics:
1. Controls:
 - a. Control shall be accomplished through the use of a factory-installed, microprocessor-based control system and associated electronic and electrical hardware. Control system shall determine control sequences

through monitoring the following operational variables:

- 1) Day and Time.
 - 2) Schedule (Unoccupied/Occupied).
 - 3) Set points (Unoccupied/Occupied, Economizer, Duct Pressure, others).
 - 4) Space temperature.
 - 5) Outdoor air temperature.
 - 6) Unit supply-air temperature.
 - 7) Unit return-air temperature.
 - 8) Supply-air fan status.
 - 9) Economizer position.
 - 10) Compressor suction and discharge pressure.
 - 11) Scrolling marquee display.
 - 12) Accessory and/or field-supplied sensors, function switches and/or signals.
- b. Controls shall be capable of performing the following functions:
- 1) Capacity control based on supply-air temperature and compensated by rate of change of return-air temperature (VAV) or room temperature (CV). Capacity control shall be accomplished through the use of compressor staging or optional variable output compressors.
 - 2) Perform a quick test to check the status of all input and output signals to the control system using scrolling marquee or Navigator™ display.
 - 3) Control of integrated economizer operation, based on unit supply-air temperature.
 - 4) Supply fan volume control shall control output from a variable frequency drive to maintain duct static pressure at user-configured set point (VAV). Static pressure reset in conjunction with Carrier communicating terminals to reduce supply fan power requirements. Control system calculates the amount of supply static pressure reduction necessary to cause the most open damper in the system to open more than the minimum value (60%) but not more than the maximum value (90% or negligible static pressure drop).
 - 5) Heating control shall provide space temperature control for unoccupied period heating, morning warm-up sequence and occupied period heating (when configured).
 - 6) Adaptive optimal start shall determine the time unit will commence cooling (or heating or heating for morning warm-up) during the unoccupied mode to ensure occupied space reaches the set point in time for occupied mode.
 - 7) Adaptive optimal stop shall turn off the compressors a preset amount of time before the end of the occupied mode to conserve energy (CV only).
 - 8) Alerts and Alarms: Control shall continuously monitor all sensor inputs and control outputs to ensure safe and proper system operation. Alerts shall be generated whenever sensor conditions have gone outside criteria for acceptability. Alarms shall be initiated when unit control detects that a sensor input value is outside its valid range (indicating a defective device or connection that prevents full unit operation) or that an output has not functioned as expected or that a safety device has tripped. Current alarms shall be maintained in STATUS function; up to 9 (current or reset) shall be stored in HISTORY function for recall.
 - 9) Timed override function shall permit a system in unoccupied mode to be returned to occupied mode for a user-configured period of 1, 2, 3 or 4 hours by pressing the override button on the front of the space temperature sensor.
 - 10) Nighttime Free Cooling (NTFC) shall start the supply fan and open the economizer on cool nights to precool the building structure mass using only outdoor air. Function shall be restricted to operation above a user-configured low lockout temperature set point.
 - 11) Modulating power exhaust control shall modulate capacity of exhaust fan system in response to building static pressure at user-configured set point. Power exhaust fan operation shall be interlocked with supply fan operation.
 - 12) Return fan control (on optional return fan equipped units only) shall measure supply fan CFM and modulate return fan to maintain constant CFM differential between supply and return fan. Return fan operation shall be interlocked with supply fan operation. Capacity of exhaust air shall modulate in response to building static pressure at user-configured set point.
 - 13) Smoke control functions: Control shall initiate any of four separate smoke control functions in response to closure of field switches. Functions shall include: Pressurization, Evacuation, Smoke Purge and Fire Shutdown. Should two or more switches be closed simultaneously, Fire Shutdown shall be initiated.
 - 14) Support demand controlled ventilation through a reset of the economizer's minimum position. This reset based on differential CO₂ ppm (outdoor and indoor)

- can be chosen as linear or as fast or slow-acting exponential curves.
- 15) Indoor air quality (IAQ) mode shall admit fresh outdoor air into the space whenever space air quality sensors detect unsuitable space conditions, by overriding economizer minimum damper position. IAQ shall be permitted only during occupied periods, unless configured to be allowed during unoccupied periods also.
 - 16) Provide control for reheat via auxiliary heating coil during ventilation.
 - 17) IAQ pre-occupancy purge function shall provide complete exchange of indoor air with fresh air during unoccupied periods, when outdoor conditions permit. Function shall energize supply fan and open economizer two hours before next occupied period; duration of purge shall be user-configured (5 to 60 minutes).
 - 18) Outdoor Air Control (OAC) function shall maintain a minimum quantity of outdoor airflow into an occupied space. OAC mode shall be available only during an occupied period. Outdoor airflow shall be monitored by an airflow station and transducer. Economizer maximum damper opening position during OAC mode shall be user-configured.
 - 19) Dehumidification and Reheat: Dehumidification function shall override comfort condition set points to deliver cooler air into the space and satisfy a user-configured humidity set point at the space or return air humidity sensor. Reheat function shall energize an auxiliary heating device should dehumidification operation result in cooling of the space down to the occupied heating set point.
 - 20) Supply Air Temperature Set Point Reset: Control shall automatically reset the unit supply air temperature set point on VAV models from either space temperature or return-air temperature, at user-configured rate and limit. Control shall also reset supply air temperature set point via external 2 to 10 vdc signal representing 0° to 20° F range of reset. Control shall respond to higher of either reset if both are active.
 - 21) Space Temperature Offset function shall permit occupants to adjust space temperature set point by $\pm 5^{\circ}$ F using T-56 space sensor (equipped with sliding scale adjuster).
 - 22) Lead-lag function shall distribute starts between the two refrigeration circuits in an effort to equalize the running time on the two circuits.
 - 23) Condenser-fan cycling control shall maintain correct head pressure down to 0° F.
 - 24) Refrigeration system pressures shall be monitored via pressure transducers. Alarms for low pressure, high pressure will be permitted.
 - 25) Timed Discrete Output function shall control an external function or device via user-configured activity schedule. This schedule shall be separate and different from the unit's occupied/unoccupied time schedule.
 - 26) Hydronic heating coil control shall modulate a control valve in a steam or hydronic heat system to maintain space temperature at user-configured set points. Control valve actuator shall communicate via LEN (Local Equipment Network) protocol.
 - 27) Humidifier control shall provide control for either LEN communicating control valve or discrete-type output, to maintain space humidity conditions at user-configured set points.
 - 28) Two-step demand limit control (when used in conjunction with CEM [controls expansion module]).
 - 29) Display in Metric units: Display may be configured to display data in Metric or English (Imperial) units of measure.
2. Safeties:
- Unit components shall be equipped with the following protections:
- a. Compressors:
 - 1) Overcurrent using calibrated circuit breakers (shuts down individual compressor).
 - 2) Crankcase heaters.
 - 3) High-pressure switch (shuts down individual circuit, automatic reset type).
 - 4) Low-pressure switch (shuts down individual circuit, automatic reset type).
 - 5) Check filter switch.
 - b. Belt-Drive Fan Motors:

Overcurrent protection manual reset circuit breakers.
 - c. Airfoil Supply Fan and Airfoil Return Fan (when equipped):

High static pressure safety switch installed into the associated air plenum
 - d. [Electric Heating Section]:
 - 1) Automatic reset high-temperature limit switches.
 - 2) Heat limiters (fusible links).
 - 3) Overcurrent protection manual reset circuit breakers.
 - 4) Branch circuit protection.

3. Diagnostics:

- a. The display shall be capable of indicating a safety lockout condition (alarm) through an expandable scrolling display.
- b. The display shall also be capable of indicating an alert condition which does not lock out the unit, but informs the system monitor of a condition which could be detrimental to either the unit or the comfort of the occupants if allowed to continue.
- c. Test mode must also be capable of displaying outputs of microprocessor-controller and to verify operation of every thermistor, actuator motor, fan, and compressor before unit is started.

L. Operating Characteristics:

1. Unit shall be capable of starting and running at 115 F ambient outdoor temperature per maximum load criteria of AHRI Standard 340/360, latest edition.
2. Unit shall be capable of mechanical cooling operation down to 32 F ambient outdoor temperature (-20 F with low ambient accessory).
3. Provides multi-stage cooling capability.
4. [Provides 2 stages of electric heating capability.]

M. Motors:

1. Compressor motors shall be cooled by suction gas passing over motor windings.
2. Condenser-fan motors shall be 3-phase, totally enclosed type with permanently lubricated ball bearings and internal over-temperature protection.
3. Supply and exhaust fan motors shall be of the 3-phase, NEMA (National Electrical Manufacturers Association) rated, open drip-proof (ODP), ball bearing type, with efficiencies per EISA (Energy Independence and Security Act) of 2007 (U.S.A.) requirements.

N. Electrical Requirements:

All unit power wiring shall enter unit cabinet at a single location.

O. Special Features:

1. Digital Compressor:

A digital compressor shall be available on the lead circuit for constant volume and variable air volume configurations. The ComfortLink control system shall be capable of unloading this compressor in an infinite number of steps from 100% of unit capacity down to 50% of unit capacity.

2. Humidi-MiZer® Adaptive Dehumidification:

The Humidi-MiZer dehumidification system shall be factory installed with an e-coated reheat coil, and shall provide greater dehumidification of the occupied space by using two

modes of dehumidification instead of the normal design cooling mode of the unit.

- a. Subcooling mode shall further sub-cool the hot liquid refrigerant leaving the condenser coil when both temperature and humidity in the space are not satisfied.
- b. Hot gas reheat mode shall mix a portion of the hot gas from the discharge of the compressor with the hot liquid refrigerant leaving the condenser coil to create a two-phase heat transfer in the system, resulting in a neutral leaving-air temperature.
- c. The system shall be equipped with modulating control valves to provide precise leaving air temperature control. On-off, cycling type control shall not be acceptable.

3. Integrated Economizer:

Dry bulb, differential dry bulb temperature, enthalpy, or optional differential enthalpy controlled integrated type consisting of dampers, actuator, and linkages in conjunction with control system to provide primary cooling using outdoor air, enthalpy permitting, supplemented with mechanical cooling when necessary.

- a. Economizer shall meet the requirements of the California Energy commission airside economizer acceptance test.
- b. Dampers shall be a gear driven low-leakage type.
- c. Actuator shall have a spring-return feature which shuts dampers upon a power interruption or unit shutdown. Actuators are capable of internal diagnostics.
- d. Equipped with a solid-state humidity sensor that is capable of sensing outdoor-air heat content (temperature and humidity) and controlling economizer cut-in point at most economical level. The user can also configure dew point limiting.

4. Ultra Low Leak Economizer:

Dry bulb, differential dry bulb temperature, enthalpy, or optional differential enthalpy controlled integrated type consisting of dampers, actuator, and linkages in conjunction with control system to provide primary cooling using outdoor air, enthalpy permitting, supplemented with mechanical cooling when necessary.

- a. Economizer shall meet the requirements of the California Energy Commission Title 24 economizer requirements.
- b. Dampers shall be a gear driven ultra low leakage type with blade and edge seals. Dampers shall exhibit a maximum leakage rate of 3 cfm per square foot of area at 1 in. wg pressure differential when tested in

- accordance with AMCA (Air Movement and Control Association) Standard 500.
- c. Actuator shall have a spring-return feature which shuts dampers upon a power interruption or unit shutdown. Actuators are capable of internal diagnostics.
 - d. Equipped with a solid-state humidity sensor that is capable of sensing outdoor-air heat content (temperature and humidity) and controlling economizer cut-in point at most economical level. The user can also configure dew point limiting.
5. Modulating Power Exhaust with VFD (Variable Frequency Drive):
- Package shall include 2 double-width, double-inlet centrifugal belt drive, forward-curved power exhaust fans with variable frequency drive control of each fan to maintain a field-adjustable interior space pressure set point.
- a. Fan bearings shall be of the pillow block type with an average design life of 200,000 hours.
 - b. Fans shall be statically and dynamically balanced.
 - c. Bypass for the VFD shall be available as a factory-installed option.
 - d. Differential pressure transducer for monitoring space pressure.
 - e. Exhaust air hood assemblies containing backdraft dampers on each fan outlet, factory installed.
 - f. All wiring and pressure tubing (except to space pressure pickup location) shall be factory supplied and installed.
6. High-Capacity Modulating Power Exhaust System (75 to 100 ton units only):
- High-capacity modulating power exhaust system shall be factory-installed and contain fans and motors, exhaust hoods and controls (including variable frequency drive and staging sequence) to maintain space pressure at user-configured set point.
- a. Dual fan assemblies with individual motors.
 - b. Variable frequency drive for modulating capacity of lead fan.
 - c. Staged control on lag fan.
 - d. Differential pressure transducer for monitoring space pressure.
 - e. Exhaust air hood assemblies containing backdraft dampers on each fan outlet, factory installed.
 - f. All wiring and pressure tubing (except to space pressure pickup location) shall be factory supplied and installed.
7. Return Fan/Building Pressure Control (75 to 100 ton units only):
- a. Functions provided shall be:
 - 1) Airflow control for return duct path (dedicated to overcoming flow losses in return duct system).
 - 2) Modulate return airflow rate to track supply fan airflow rate and maintain a user set delta cfm between the supply and return airflow.
 - 3) Maintain building pressure by sensing building pressure and modulating fan speed.
 - b. Option shall consist of following hardware:
 - 1) Plenum fan assembly, with welded steel airfoil blade fan.
 - 2) Spring isolation.
 - 3) Belt-drive fan system, fixed pitch for maximum belt life and reliability.
 - 4) Variable frequency drive (VFD) for return fan modulation control.
 - 5) Supply air cfm and return air cfm sensors to measure supply and return airflow.
 - 6) Exhaust damper with outlet hood.
 - 7) Building pressure transducer.
 - 8) Shall include a high static pressure safety switch installed into the return air plenum.
 - c. Installation:
 - 1) Site installation shall require supply and installation of building pressure (BP) sensing pick-up and tube to connect to BP transducer in unit.
 - 2) All other wiring and pressure tubing shall be factory-supplied and factory installed.
8. Barometric Relief Package:
- a. Package shall relieve excess internal pressure and consist of damper assemblies, hoods, damper screens, seal strips and required hardware.
 - b. Damper assemblies shall close due to gravity upon unit shutoff.
9. Pleated Filters:
- Unit shall be factory equipped with MERV 7 pleated filters having the following characteristics:
- a. Efficiency of no less than 30% based on testing per ASHRAE Standard 52.
 - b. Minimum average arrestance of 95%.

10. High-Efficiency Pleated Filters (75 to 100 ton units only):
Unit shall be factory equipped with MERV 11 high-efficiency pleated filters having the following characteristics:
 - a. Filters shall have a design dust spot efficiency with an average of 60 to 65% based on the ASHRAE Standard 52.1 test method.
 - b. Filters shall have a minimum arrestance of 90%.
 - c. Filters shall be classified as a Class 2 air filter according to UL Standard 900.
11. Bag Filters with Prefilters (30 to 70 ton units only):
Unit shall be factory equipped with MERV 15 bag filters and 2-in. prefilters, and shall have an average efficiency of 90% based on testing per ASHRAE Standard 52.
12. Cartridge Filters with Prefilters (30 to 70 ton units only):
Unit shall be factory equipped with cartridge filter mounting system with 2-in. prefilters.
13. Supply Fan Variable Frequency Drive:
Variable air volume and staged air volume units shall be equipped with variable frequency drive (VFD) inverter. The VFD shall be factory-mounted, wired, and tested. The variable speed drive shall include the following features:
 - a. Factory-supplied VFDs qualify, through ABB, for a 24-month warranty from date of commissioning or 30 months from date of sale, whichever occurs first.
 - b. Full digital control with direct control from the unit ComfortLink controls.
 - c. Insulated gate bi-polar transistors (IGBT) used to produce the output pulse width modulated (PWM) waveform, allowing for quiet motor operation.
 - d. Inverters capable of operation at a frequency of 8 kHz so no acoustic noise shall be produced by the motor.
 - e. VFDs shall include EMI/RFI (electromagnetic/radio frequency interference) filters.
 - f. Digital display keypad module, mounted on the VFD enclosure.
 - g. Local/Remote and Manual/Auto function keys on the keypad.
 - h. UL-listed electronic overload protection.
 - i. Critical frequency avoidance.
 - j. Self diagnostics.
 - k. On-board storage of unit manufacturer's customer user settings, retrievable from the keypad.
1. RS485 communications capability (accessory card source required).
- m. Internal thermal overload protection.
- n. 5% swinging (non-linear) chokes for harmonic reduction and improved power factor.
- o. All printed circuit boards shall be conformal coated.
14. Supply Fan Static Pressure Control (VAV units):
Variable air volume units shall be equipped with a supply fan VFD. The VFD shall control motor speed to maintain set point static pressure control at the supply duct sensor tube location. The supply fan drive shall be field-adjustable to maintain supply duct static pressure set point from 0.0-in. wg to 5-in. wg, adjusted via scrolling marquee display or Navigator™ display. A pressure transducer shall be factory-mounted and wired. (Control tubing from sensor tube location to transducer shall be field-supplied and installed.) Transducer shall provide a 4 to 20 mA signal to the unit control module; unit control module shall provide a 4 to 20 mA signal to the VFD indicating desired VFD output level
15. Staged Air Volume (SAV™) units:
Staged air volume units shall be equipped with a supply fan VFD. The VFD shall control motor speed to user configurable speeds. High speed shall be a percentage of 60 Hz, and shall be user configurable. The range of adjustment for high speed shall be between 67 and 100% of 60 Hz. Low speed shall be a percentage of 60 Hz, and shall be user configurable. The range of adjustment for low cooling speed shall be between 33 and 67% of 60 Hz. The range of adjustment for low heating speed shall be between 75 and 100% of 60 Hz. The control shall allow user configurable fan speeds for cooling and heating modes.
16. Discharge Plenum:
Discharge plenum design shall contain added length module for bottom supply air discharge, as shown in contract drawings. Discharge plenum design shall provide horizontal discharge arrangement supply fan which shall discharge into insulated plenum. Interior cabinet surfaces within discharge plenum section shall be lined with sheet metal on all surfaces, insulated on the side opposite the airstream.
Electric heat is not available with discharge plenum models.
17. Extended Chassis:
Extended chassis designs shall contain an added length module, after the evaporator section, as shown in the contract drawings. Module shall contain tracks to accept field-supplied/installed auxiliary heating coil.

18. Non-Fused Disconnect:
A non-fused electrical disconnect for main unit power shall be factory installed. The disconnect shall be an interlocking through-the-door type.
19. 115-Volt Convenience Outlet:
A duplex GFCI (ground fault circuit interrupt) receptacle shall be factory mounted in a weatherproof enclosure and wired for a 10-amp load. It will remain powered when all unit circuit breakers have been turned off. The outlet will be deenergized by the unit disconnect.
20. Navigator™ Display Module:
The Navigator display module shall be a portable hand-held display module with a minimum of 4 lines and 20 characters per line, of clear English, Spanish, Portuguese or French language. Display menus shall provide clear language descriptions of all menu items, operating modes, configuration points and alarm diagnostics. Reference to factory codes shall not be accepted. An industrial grade coiled extension cord shall allow the display module to be moved around the chiller. Magnets shall hold the display module to any sheet metal panel to allow hands-free operation. Display module shall have NEMA 4x housing suitable for use in outdoor environments. Display shall have back light and contrast adjustment for easy viewing in bright sunlight or night conditions. The display module shall have raised surface buttons with positive tactile response.
21. Controls Expansion Module (CEM):
Factory-installed package shall include all hardware for additional control of base unit operation and product integrated controls features. The functions supported are:
 - a. Building pressurization, evacuation, and smoke purge control.
 - b. Supply air reset from external 4 to 20 mA signal.
 - c. Two-step demand limit inputs (when used with the CCN [Carrier Comfort Network®]).
 - d. Indoor air quality (IAQ) switch monitoring.
 - e. Outdoor airflow monitoring.
 - f. Outdoor humidity monitoring.
 - g. Space humidity monitoring (required for dehumidification control, reheat and humidifier control).
 - h. Return air humidity monitoring.
 - i. Demand limiting from an external 4 to 20 mA signal.
 - j. Static pressure reset from an external 4 to 20 mA signal.
22. Relative Humidity Sensors:
Package shall contain either duct-mounted or wall-mounted sensors to measure the relative humidity of the air within the occupied space (specify location) or return duct and/or outside air.
NOTE: For relative humidity sensor monitoring, the CEM must also be ordered.
23. Indoor Air Quality (CO₂) Sensor:
 - a. Shall have the ability to provide demand ventilation indoor-air quality (IAQ) control through the economizer with an indoor air quality sensor.
 - b. The IAQ sensor shall be available in duct mount, wall mount, and wall mount with LED display of CO₂ in parts per million. The set point shall have adjustment capability.
24. Return Air Smoke Detector:
The smoke detector shall send input to the controller to shut down the unit in case smoke is detected.
25. Outdoor Airflow Sensor:
Outdoor airflow sensor package shall contain a airflow station with airflow sensor, a transducer and all hardware required to measure the quantity of outdoor air brought in through the economizer dampers. Optional economizer and CEM are required with this accessory.
This airflow sensor shall control to the following airflow ranges:
Sizes 030-050: 2,500 to 12,500 CFM
Sizes 055-070: 3,000 to 17,000 CFM
Sizes 075-100: 5,000 to 21,000 CFM
26. Differential Enthalpy Switch or Sensors (when equipped with both return air and outdoor air humidity sensors):
 - a. For use with economizer only.
 - b. Capable of comparing heat content (temperature and humidity) of outdoor and return air and controlling economizer cut-in point at the most economical level.
27. Hot Gas Bypass:
Unit shall be factory equipped with hot gas bypass valve and tubing to maintain capacity control at minimal cooling loads.
28. Condenser Coil Protective Coating — E-Coated Microchannel Coil:
E-coated aluminum microchannel coils shall have a flexible epoxy polymer coating uniformly applied to all coil external surface areas without material bridging between fins or louvers. Coating process shall ensure complete coil encapsulation, including all exposed fin edges. E-coat thickness of 0.8 to 1.2 mil with top coat having a uniform dry thickness from 1.0 to 2.0 mil on all external coil surface areas, including fin edges, shall be provided. E-coated coils shall have superior hardness characteristics of 2H per ASTM D3363-00 and cross-hatch adhesion

- of 4B-5B per ASTM D3359-02. E-coated coils shall have superior impact resistance with no cracking, chipping, or peeling per NSF/ANSI 51-2002 Method 10.2.
29. Condenser Coil Hail Guard (sizes 040 to 060 only):
Canted face enclosure and welded wire grille complete with support retainers and fasteners shall be provided for protection of condenser coils. Field-assembled.
 30. BACnet Communication Option:
Shall provide factory-installed communication capability with a BACnet MS/TP network. Allows integration with i-Vu® Open Control System or a BACnet Building Automation System.
 31. MODBUS Protocol Translator:
A controller-based accessory module shall provide CCN access to MODBUS Remote Terminal Unit (RTU) protocol conversion.
 32. LonWorks Protocol Translator:
A controller-based accessory module shall provide CCN access to LON FT-10A ANSI/EIA-709.1 protocol conversion.
 33. Space Temperature Sensor (T-56):
The T-56 space temperature sensor (for CV applications) shall monitor space temperature. Device shall be suited for wall mounting in the occupied space. The T-56 sensor shall incorporate a front-panel located slider switch to effect a remote change in set point of $\pm 5^{\circ}$ F. The T-56 sensor shall also include a button used to initiate Unoccupied Override function.
 34. Space Temperature Sensor (T-56) with CO₂ Sensor:
This device shall incorporate interior space temperature sensing and interior space CO₂ level monitoring functions. Space temperature sensor shall sense the actual temperature in the conditioned space via 10,000-ohm thermistor. Temperature set point adjustment potentiometer via slide scale shall provide $\pm 5^{\circ}$ F adjustment. CO₂ sensor shall provide CO₂ measurement range of 0 to 2000 ppm. IAQ signal to unit base board terminals shall be 4 to 20 mA. Sensor shall be equipped with an override button for timed override. Sensor must be powered by a separate field-supplied 24-v transformer.
 35. Suction and Liquid Service Valves:
Shall be equipped with ball type service valves in the suction and liquid line for each circuit.
 36. Discharge Service Valve:
Shall be equipped with a ball type service valve in the discharge line of each circuit.
 37. Replaceable Core Filter Drier:
Shall be equipped with a replaceable core filter drier in each liquid line.
 38. Roof Curb:
Designed to comply with criteria established by NRCA Guideline B-1986.
 - a. Size 030-060 Units:
Formed 14-gage galvanized steel with wood nailer. Supports full perimeter of unit.
 - b. Size 070-100 Units:
Formed 14-gage galvanized steel with wood nailer strip as perimeter curb supporting the air-handling portion of unit, and rail for supporting the condenser portion of the unit.
 39. Roof Curb Condenser Section (accessory for size 070-100 units only):
Formed 14-gage galvanized steel with wood nailer strip for supporting condenser section of the unit to complete a full perimeter curb under entire unit.
 40. [Silicon Controlled Rectifier (SCR) Controlled Electric Heat (30 to 70 ton units only):]
 - a. SCR electric heat option shall monitor unit supply-air temperature and control the unit heater section to provide the following sequences:
 - 1) Demand heating control, with modulation to maintain user-configured heating supply air temperature set point.
 - 2) Full output heating on heating control command.
 - 3) Tempering heat control, based on user-configured ventilation supply air temperature set point, to eliminate cold draft conditions with low mixed-air temperatures.
 - b. SCR heat control option shall consist of:
 - 1) SCR controller capable of ensuring the proper heating rates.
 - 2) Supply air temperature thermistors with duct-mounting base.
 - 3) Limit switch temperature thermistors.
 - c. Field installation shall be limited to installing three supply air temperature thermistors in the supply duct. All other hardware and wiring shall be factory-completed.
 41. Low Outdoor Sound:
Low sound fans for outdoor sound reduction shall be available as a factory-installed option for all units (except 35 ton units).
 42. Low Ambient Control:
 - a. Control shall regulate fan motor speed in response to the saturated condensing temperature of the unit. The control shall be capable of operating with outdoor temperatures at -20° F.

Guide specifications — 50P2,P3,P4,P5 units (cont)



- b. Motormaster® low ambient control shall be available as a factory-installed option or field-installed accessory for all units.
- 43. Short Circuit Current Rating (SCCR):
An optional SCCR of 65kA shall be provided for 208/230 and 460 volt units. An optional of 25kA shall be provided for 575 volt units.
- 44. Low Compressor Sound Blanket:
Low compressor sound blanket accessory shall be available for field installation.

Index



Airflow
 Maximum 7, 150
 Minimum 7, 150
Application data 150-158
Auxiliary coil 150, 158
Chassis arrangement 41-43
 Extended length 41, 43
 Horizontal discharge 42, 43
 Standard length 41, 42
 Vertical discharge 41-43
ComfortID™ controls 4
ComfortLink controls 1, 2, 144
Compressor staging 13, 14
Controls 141-149
Cooling capacities 58-114
Digital scroll compressor 3, 13, 14
Dimensions 44-56
 Accessory 52-56
 Base unit 44-51
Economizer 143
Electrical data 139, 140
Electric heater capacity 12
Features/Benefits 1-5
Gas heat capacity 7-12
Guide specifications 167-186
 48P2,P3,P4,P5 167-176
 50P2,P3,P4,P5 177-186
Hinged access doors 3
Horizontal applications 42, 43
Humidi-MiZer® system 3, 152
Indoor air quality (IAQ) 4, 143
Integrated gas controller (IGC) 5, 149
Maximum outdoor temperature 150
Minimum outdoor temperature 150
Model number nomenclature 6
Novation® technology 2, 3
Options and accessories 37-43
Performance data 58-138
Physical data 15-36
 48P2,P3,P4,P5 15-22
 50P2,P3,P4,P5 23-30
Piping and wiring (typical installation) 159
Power exhaust 4, 31, 32
 Drive data 31, 32
 Fan performance 135, 136
 Motor limitations 139, 140
Return fan 22, 30
 Drive data 32
Roof curb dimensions 52-56
 Condenser section roof curb 55, 56
Selection procedure 57
Smoke control 144
Staged gas control 3, 149
Static pressure drop 137, 138
 Economizer 137, 138
 Electric heat 137, 138
 High-capacity coil 137, 138
 Gas heat 137, 138
 Hydronic coil 137, 138
 Power exhaust 137, 138
Supply fan motor
 Drive data 31
 Motor limitations 139
 Performance 115-134
Thru-the-curb connections 150
Unit-mounted disconnect 5
Variable frequency drive 4
Vertical discharge applications 4, 41-43

Weight
 Operating 15-30
 Options and accessories 36
 Roof curb 36
 Unit distribution 33-35
Wiring 160-165
 Power wiring 160
 115-Volt 165
 Controls 163, 164
 Input/Output 161, 162
 Main Base Board 161

